



US00D325504S

United States Patent [19] Tobey

[11] Patent Number: **Des. 325,504**

[45] Date of Patent: **** Apr. 21, 1992**

[54] TUBE CUTTER

[76] Inventor: **Billey D. Tobey, 23736 E. Virgin St.,
Catoosa, Okla. 74015**

[**] Term: **14 Years**

[21] Appl. No.: **409,446**

[22] Filed: **Sep. 19, 1989**

[52] U.S. Cl. **D8/69**

[58] Field of Search **D8/69; 30/97, 98, 101,
30/90.3**

4,416,062	11/1983	Cummings	30/101
4,769,911	9/1988	Araki .	
4,831,732	5/1989	Garton	30/101
4,953,292	9/1990	Tobey	30/97

Primary Examiner—Nelson C. Holtje
Assistant Examiner—J. H. Musgrove
Attorney, Agent, or Firm—Terry M. Gernstein

[57] **CLAIM**

The ornamental design for a tube cutter, as shown and described.

DESCRIPTION

FIG. 1 is a top, front, and left-side elevational view of a tube cutter showing my new design; FIG. 2 is a left side elevational view; FIG. 3 is a rear elevational view; FIG. 4 is a top plan view; FIG. 5 is a bottom plan view; FIG. 6 is a right side elevational view; and, FIG. 7 is a rear elevation a view thereof.

[56] **References Cited**
U.S. PATENT DOCUMENTS

2,747,274	5/1956	Willard .	
2,769,235	11/1956	Martois .	
3,732,758	5/1923	Rinaldo	30/97
3,807,047	4/1974	Sherer et al.	30/97
4,149,312	4/1979	Arnot	30/98
4,347,664	9/1982	Petrillo	30/97

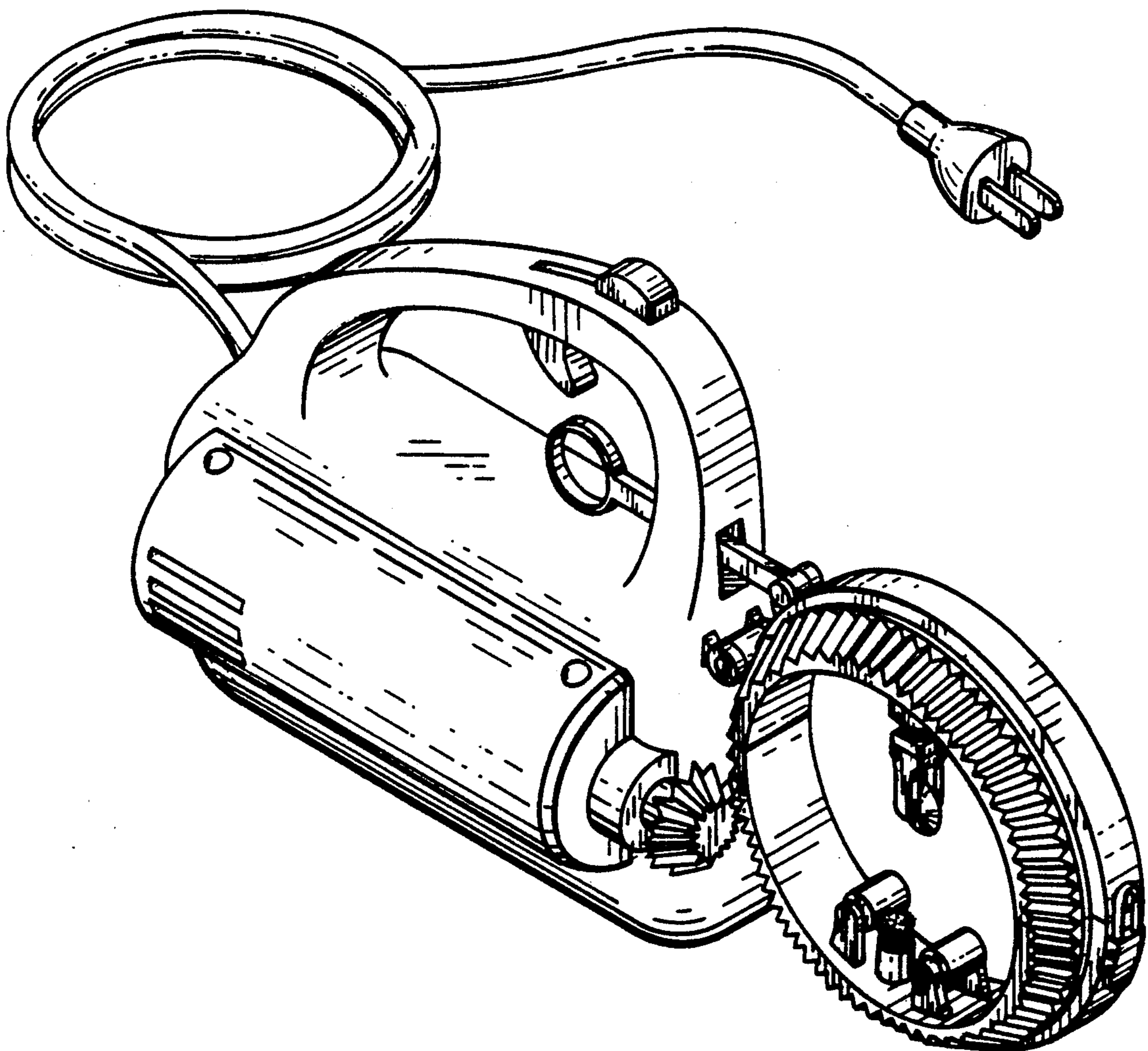

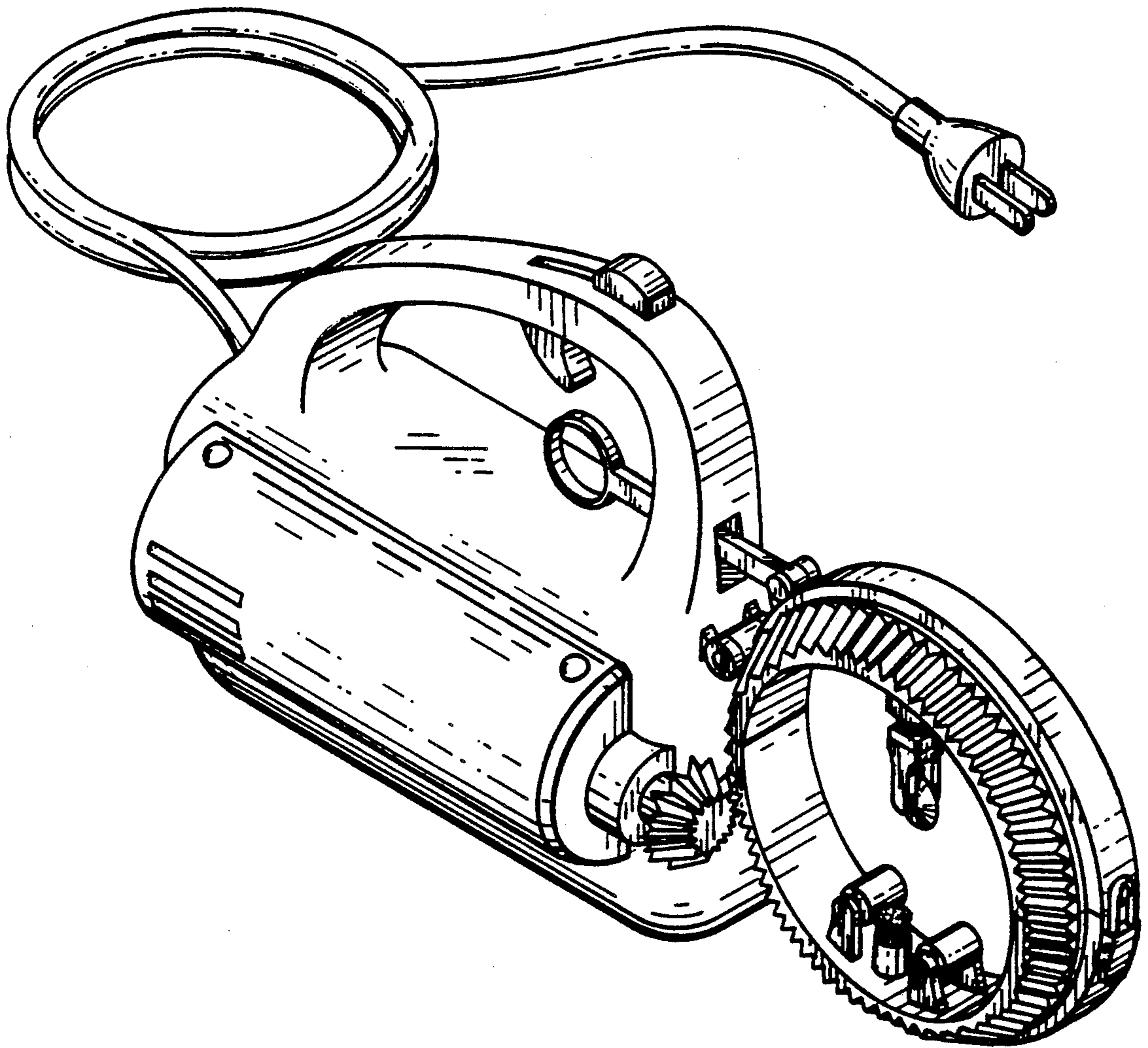

FIG. 1

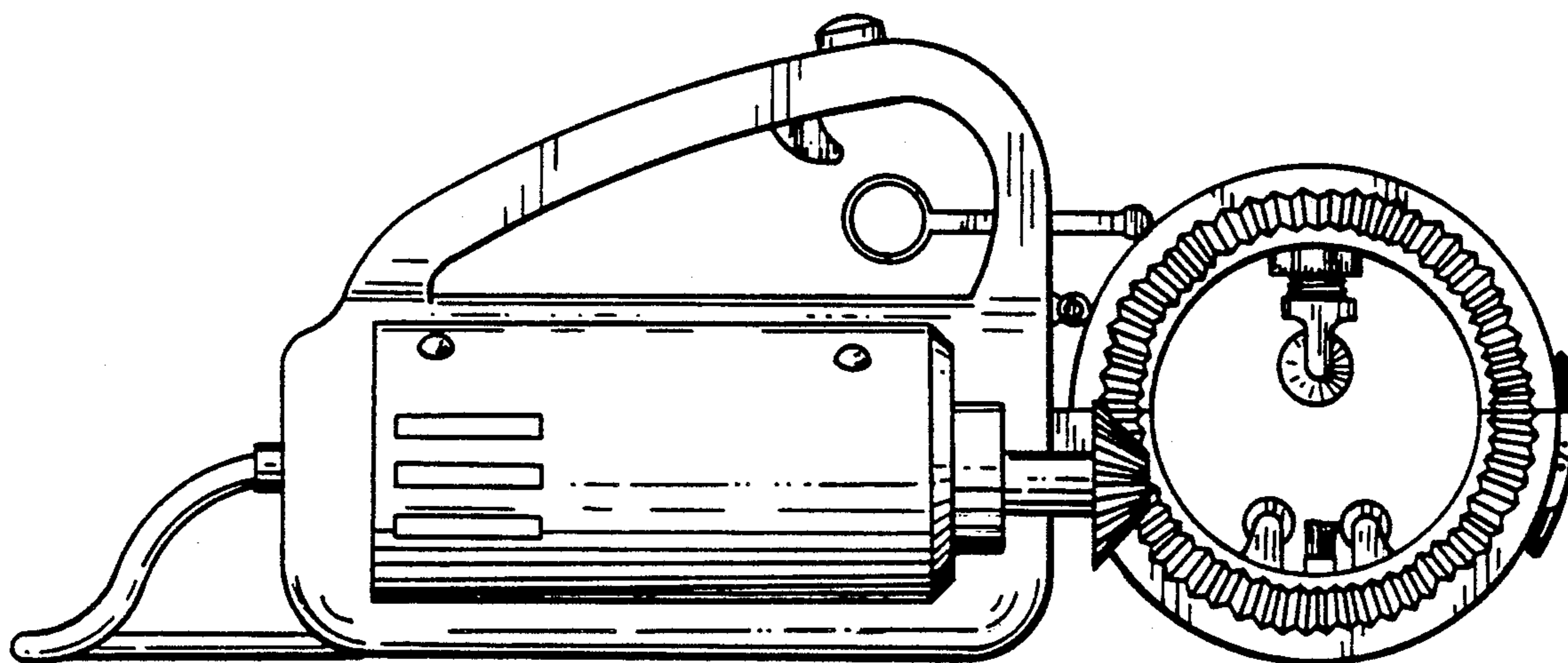

FIG. 2

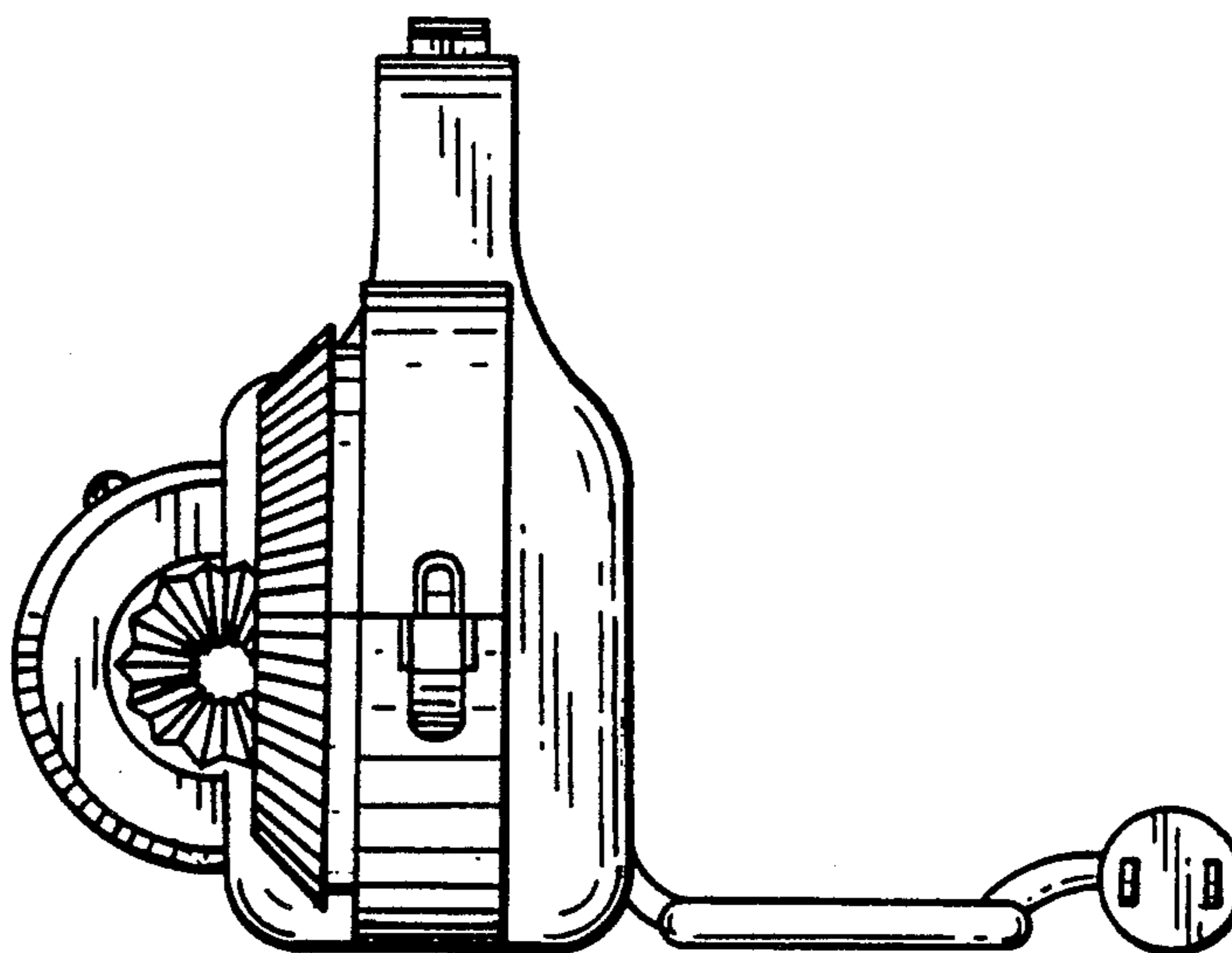

FIG. 3

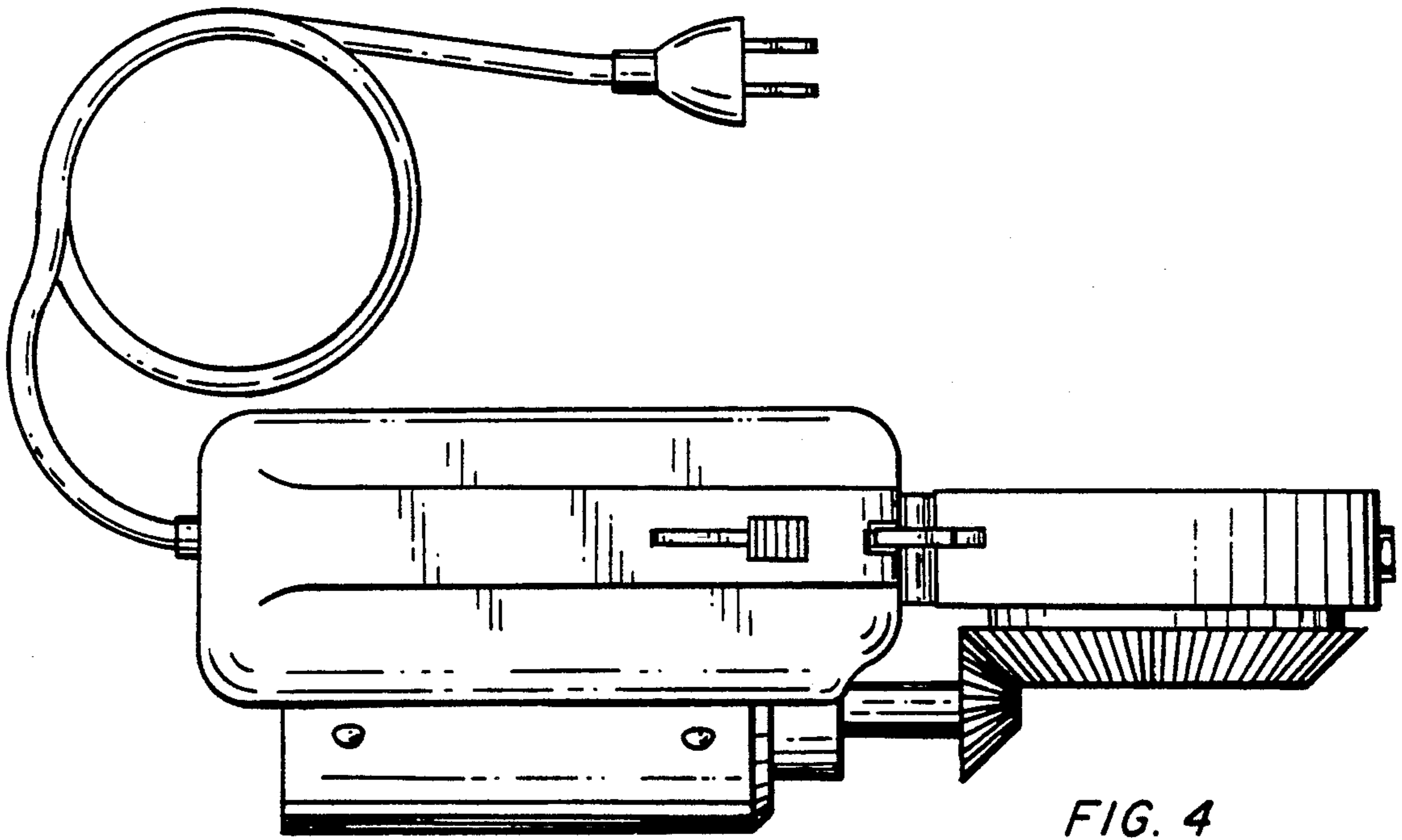

FIG. 4

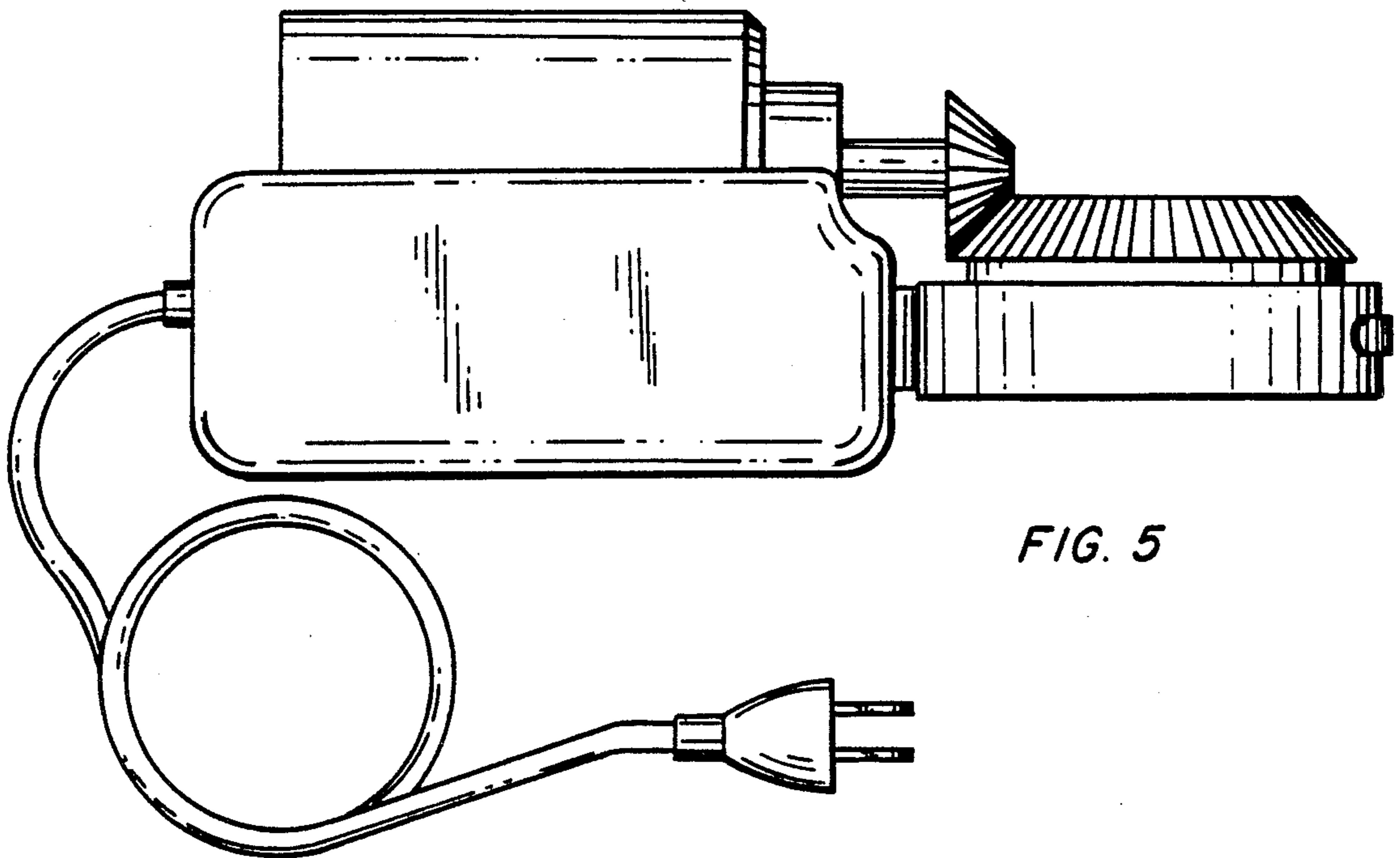

FIG. 5

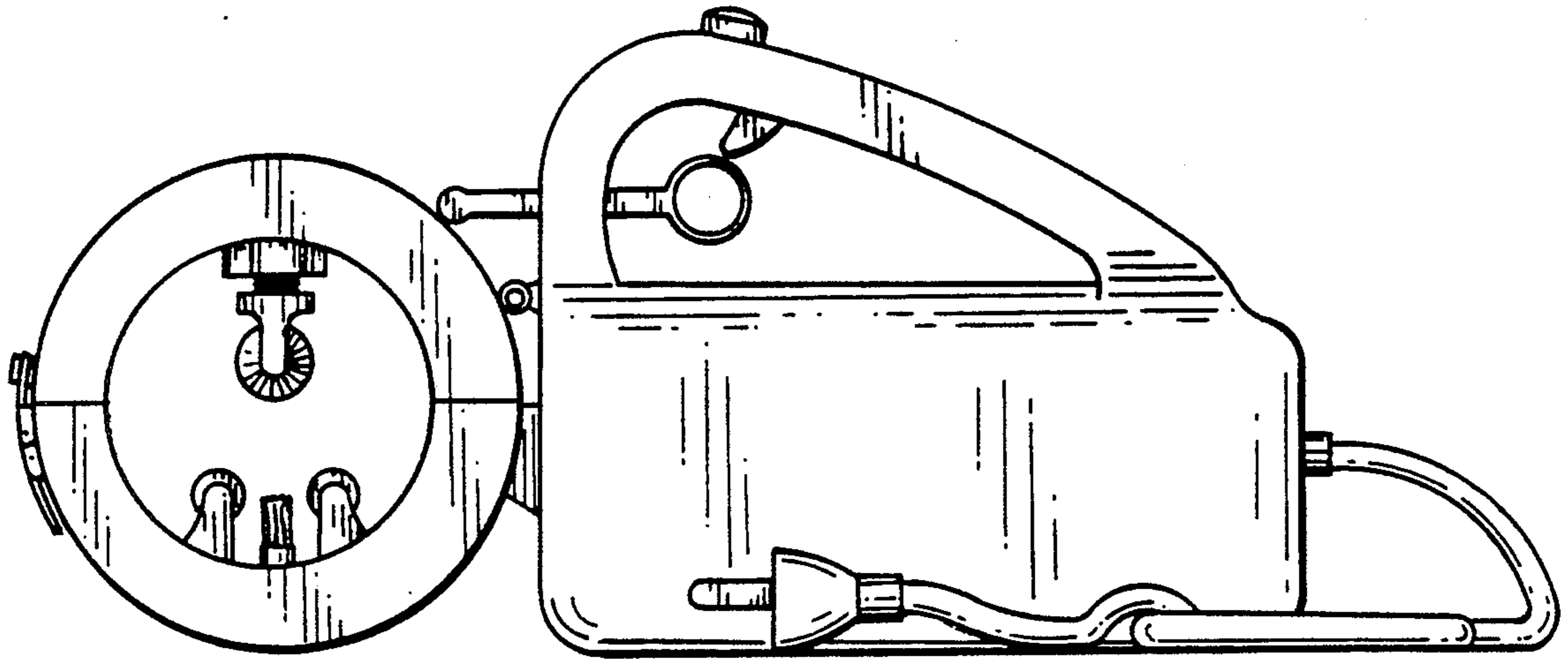

FIG. 6

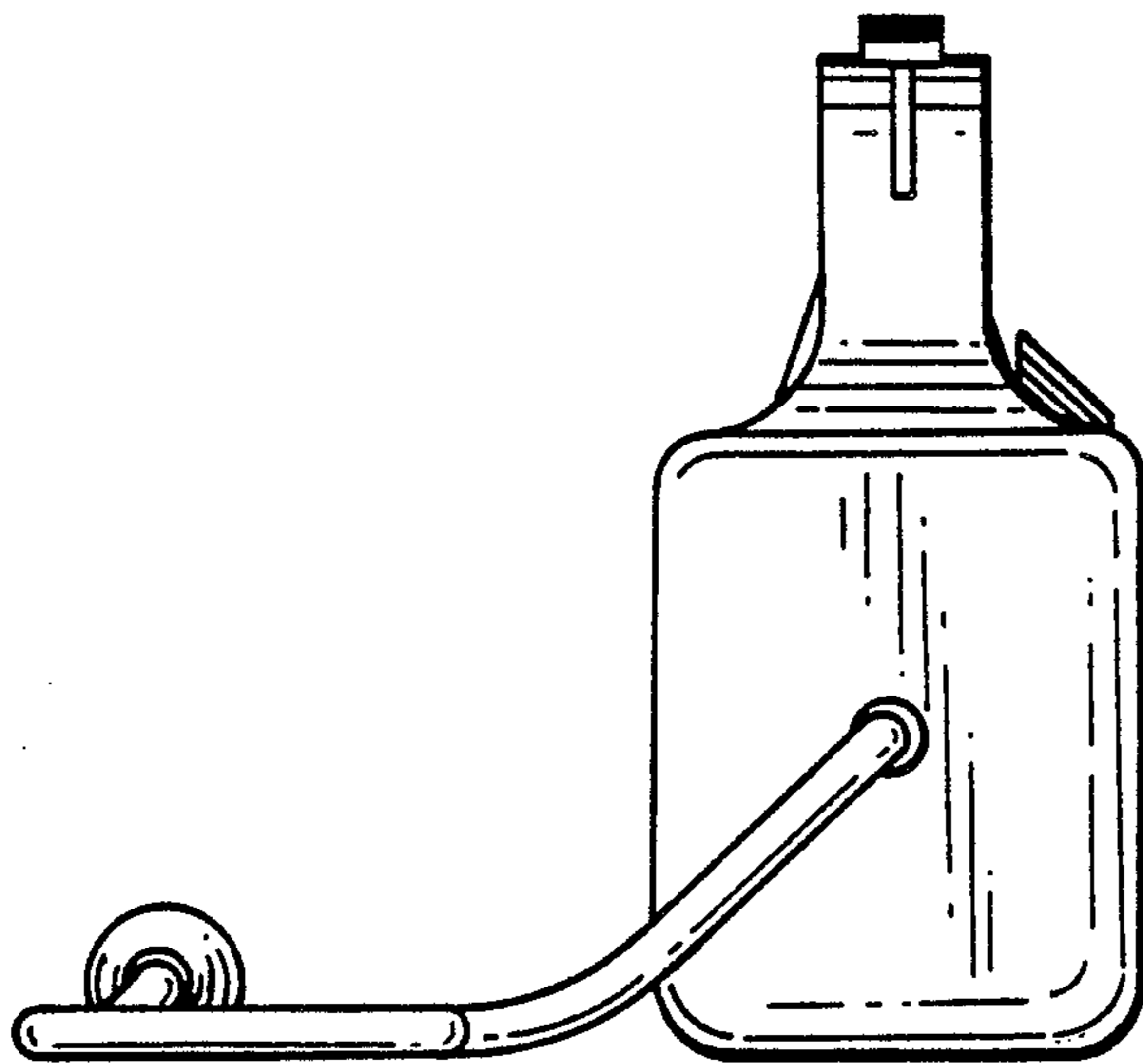

FIG. 7