



US00D325308S

# United States Patent [19]

[11] Patent Number: **Des. 325,308**

Cojan

[45] Date of Patent: **\*\* Apr. 14, 1992**

[54] **DISPLAY RACK UNIT FOR PERFUME VIALS, PACKAGES AND THE LIKE**

4,905,845 3/1990 Broeker et al. .... 211/128 X  
4,925,038 5/1990 Gajewski ..... D11/128 X

[75] Inventor: **Catherine Cojan, Paris, France**

*Primary Examiner*—Bruce W. Dunkins  
*Assistant Examiner*—Jeffrey Asch  
*Attorney, Agent, or Firm*—Mason, Fenwick & Lawrence

[73] Assignee: **Parfums Christian Dior, Paris, France**

[57] **CLAIM**

[\*\*] Term: **14 Years**

The ornamental design for a display rack unit for perfume vials, packages and the like, as shown and described.

[21] Appl. No.: **411,184**

[22] Filed: **Sep. 19, 1989**

**DESCRIPTION**

[52] U.S. Cl. .... **D6/491; D6/467; D6/469; D6/476**

[58] Field of Search ..... **D6/396, 397, 429-431, D6/462, 466-469, 475, 476, 473, 491; D9/418, 341; 211/128, 86, 59.2, 50, 13**

FIG. 1 is a perspective view of a display rack unit for perfume vials, packages and the like, showing my new design;

FIG. 2 is a top plan view thereof;

FIG. 3 is a front elevational view, the rear being a mirror image thereof;

FIG. 4 is a left side elevational view thereof;

FIG. 5 is a right side elevational view thereof; and,

FIG. 6 is a bottom plan view thereof.

FIGS. 2-6 have been shown on a reduced scale with respect to FIG. 1.

[56] **References Cited**

**U.S. PATENT DOCUMENTS**

- D. 252,306 7/1979 Denhoff ..... D6/476 X
- D. 272,027 1/1984 Hagberg ..... D6/473
- D. 291,534 8/1987 Hamilton et al. .... D9/418 X

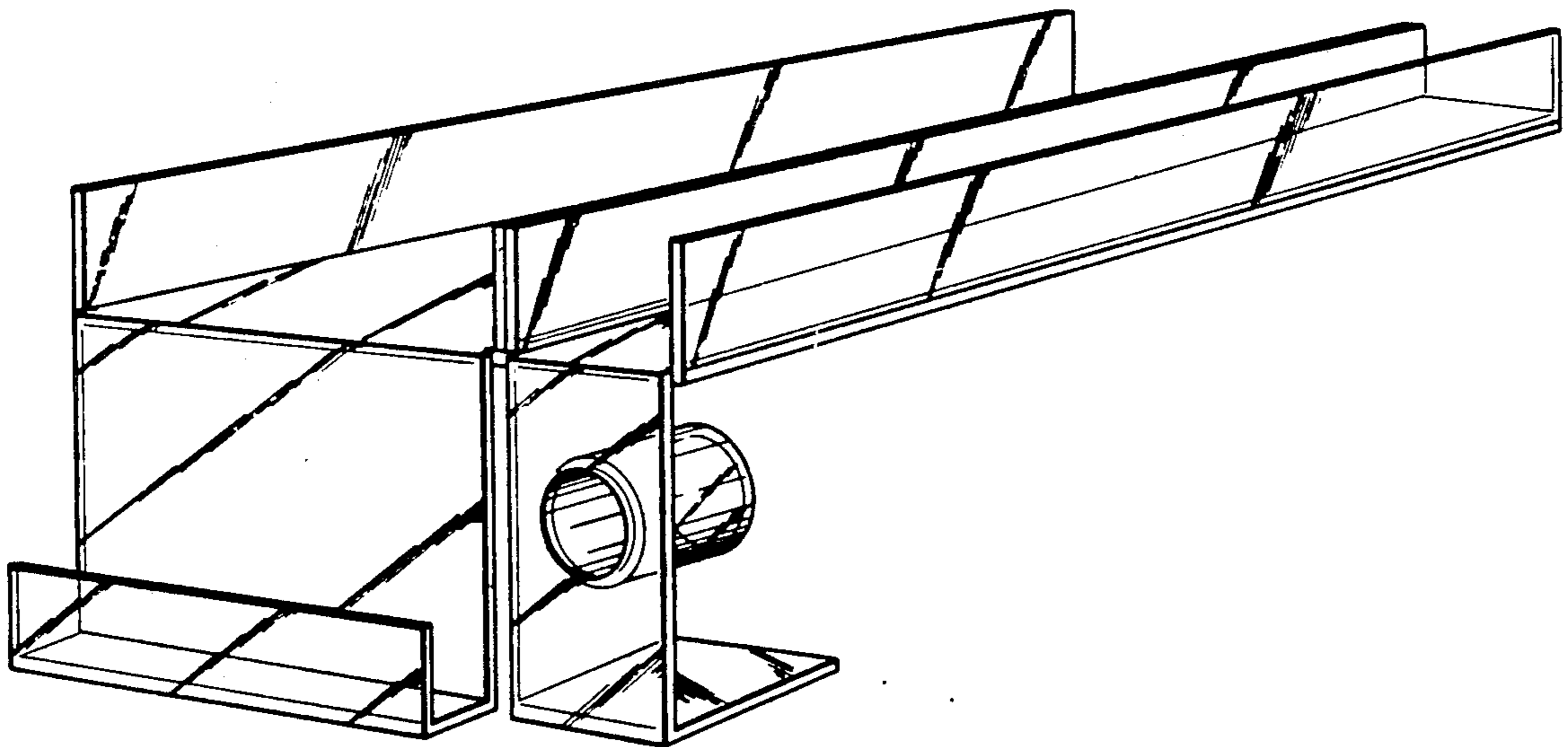

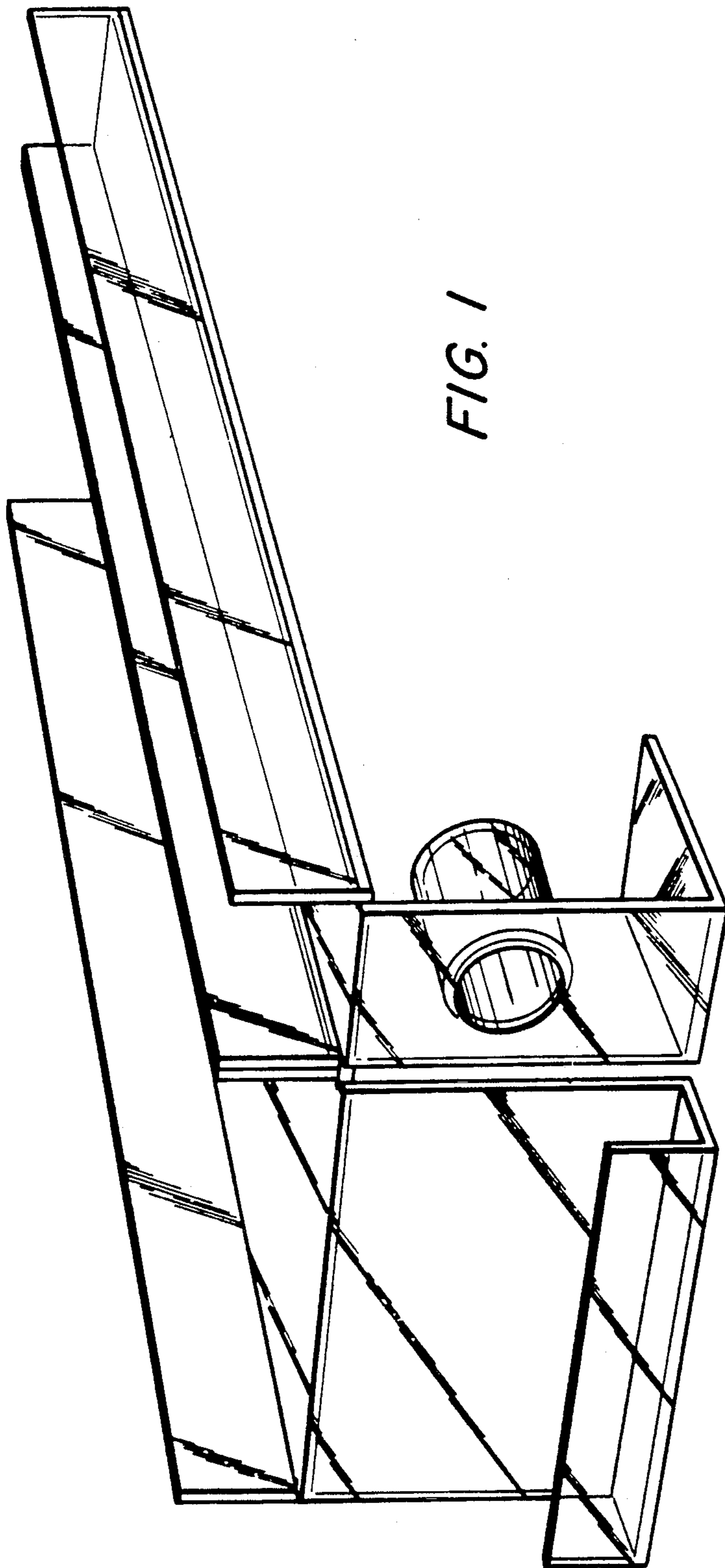

FIG. 1

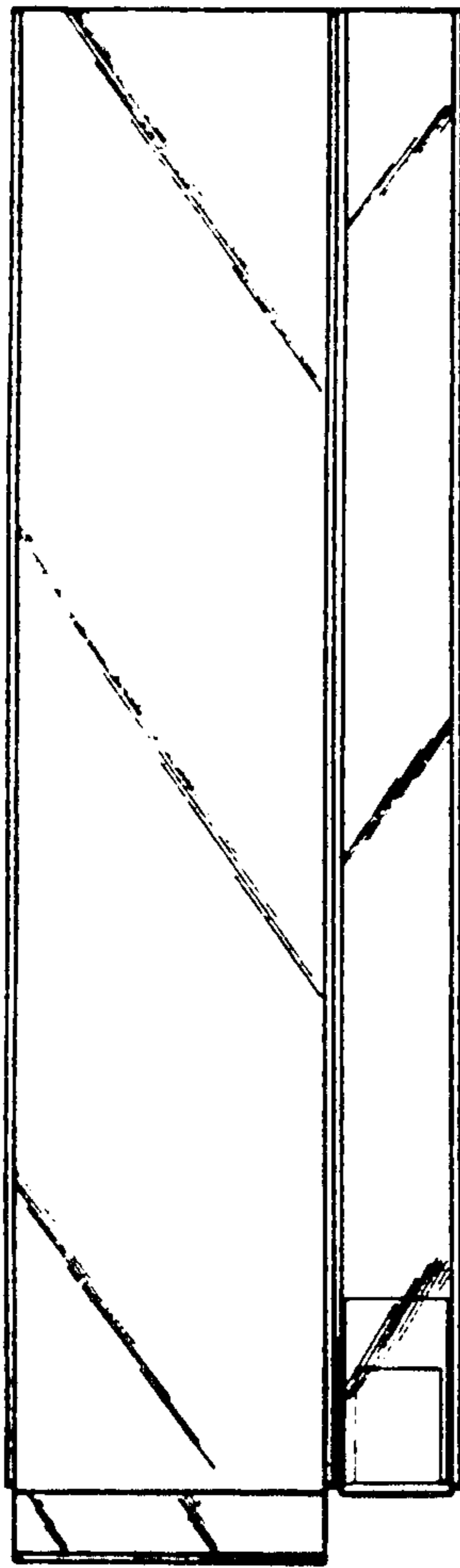

FIG. 2

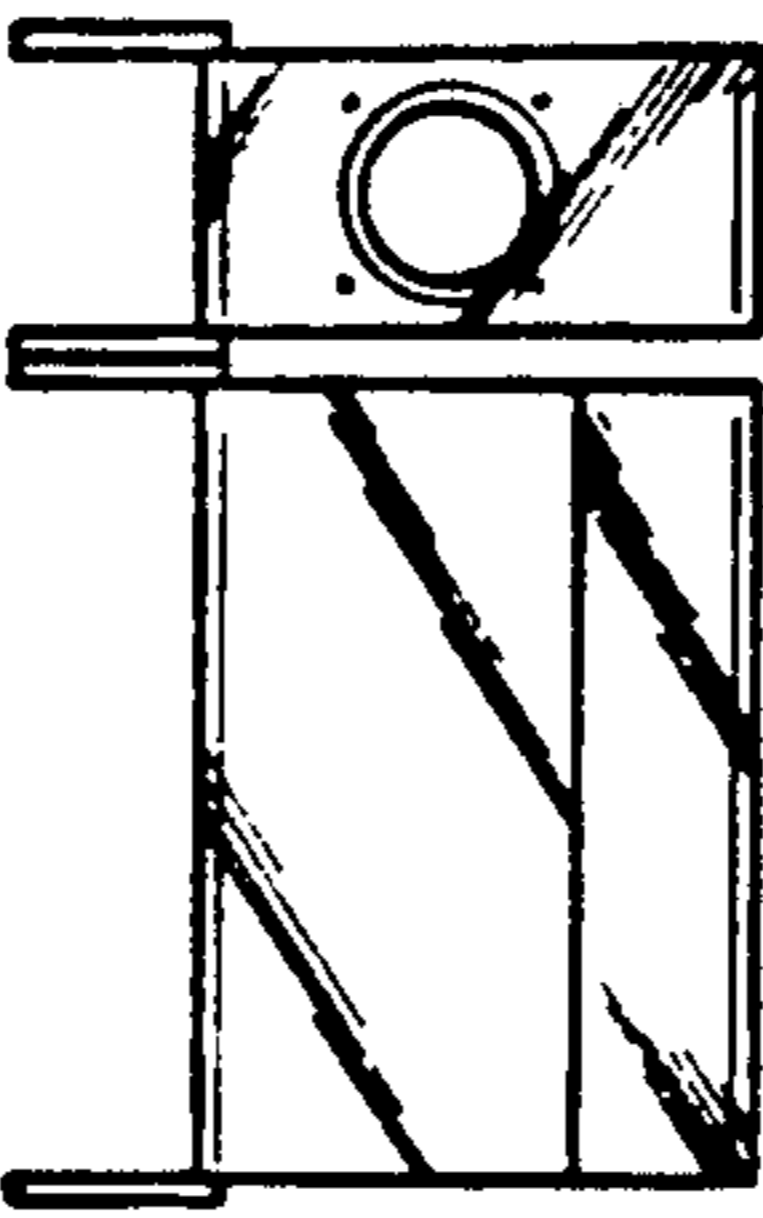

FIG. 4

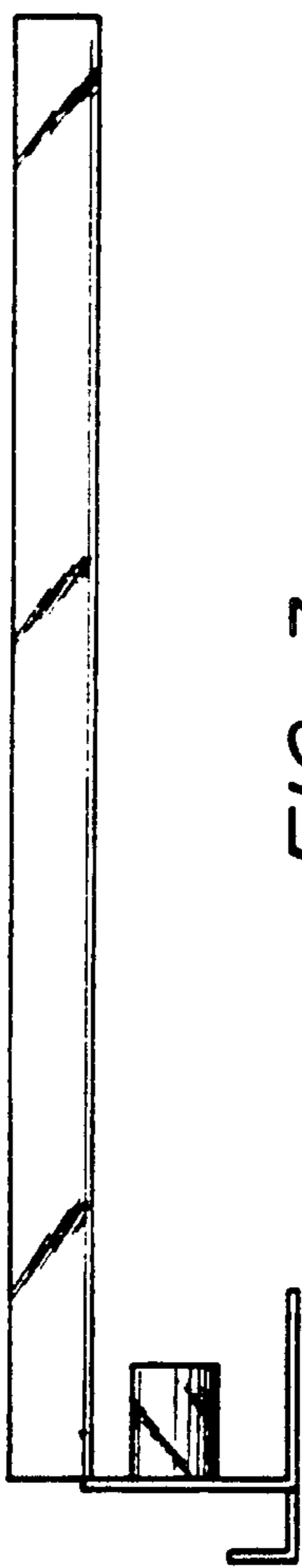

FIG. 3

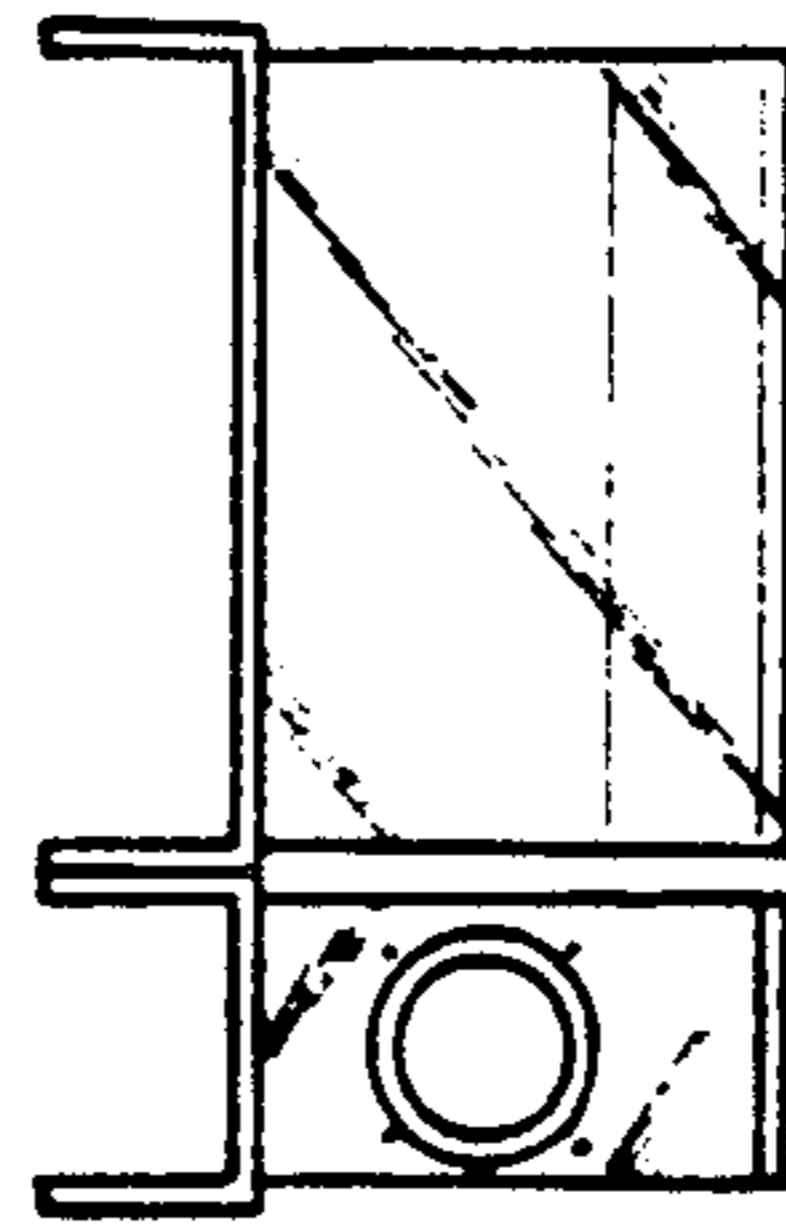

FIG. 5

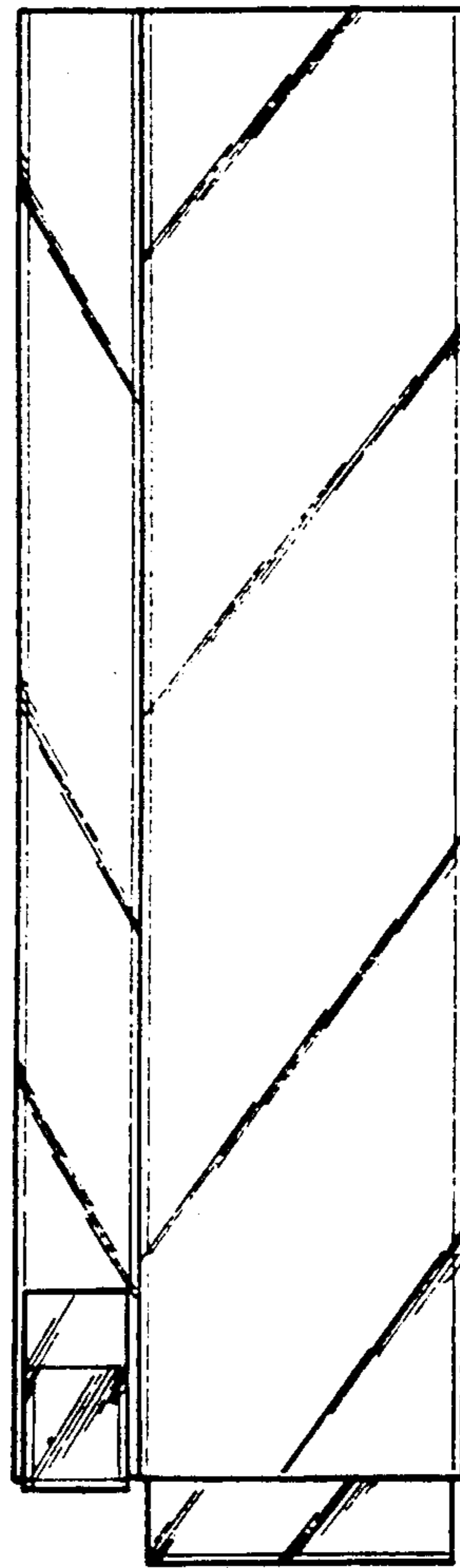

FIG. 6