



US00D325225S

United States Patent [19]

[11] Patent Number: Des. 325,225

Adhida

[45] Date of Patent: ** Apr. 7, 1992

[54] **HAND HELD CONTROLLER FOR A VIDEO GAME MACHINE**

[75] Inventor: Ken'ichiro Adhida, Kyoto, Japan

[73] Assignee: Nintendo Company Limited, Japan

[**] Term: 14 Years

[21] Appl. No.: 450,308

[22] Filed: Dec. 15, 1989

[30] Foreign Application Priority Data

Jun. 19, 1989 [JP] Japan 1-22579

[52] U.S. Cl. D21/48

[58] Field of Search D21/48, 1, 13, 142; 273/148 B, DIG. 28, 1 E, 85 G, 237, 1 GC, 138 A; D14/125, 126, 133, 107, 114; D13/158, 171, 168

[56] References Cited

U.S. PATENT DOCUMENTS

- D. 253,234 10/1979 Cooke D13/168
- D. 265,407 7/1982 Hanzawa D21/13
- D. 295,042 4/1988 Steventon et al. D14/126
- D. 302,544 8/1989 Spira D13/168
- D. 304,449 11/1989 Rodgers et al. D14/114
- 4,969,647 11/1990 Mical et al. 273/DIG. 28 X

OTHER PUBLICATIONS

Playthings, 2/1981, p. 159, Center Right of the Page.

Primary Examiner—Bernard Ansher

Assistant Examiner—Prabhakar Deshmukh

Attorney, Agent, or Firm—Nixon & Vanderhye

[57] CLAIM

The ornamental design for a hand held controller for a video game machine, as shown and described.

DESCRIPTION

FIG. 1 is a perspective view of a housing for hand held controller for a video game machine showing my new design;

FIG. 2 is a bottom perspective view thereof, showing undisclosed sides in FIG. 1;

FIG. 3 is a top plan view thereof;

FIG. 4 is a bottom plan view thereof;

FIG. 5 is a front elevational view thereof;

FIG. 6 is a rear elevational view thereof;

FIG. 7 is a right side elevational view thereof;

FIG. 8 is a left side elevational view thereof;

FIG. 9 is a top plan view of a second embodiment of FIG. 1;

FIG. 10 is a bottom plan view of FIG. 9;

FIG. 11 is a front elevational view of FIG. 9;

FIG. 12 is a rear elevational view of FIG. 9;

FIG. 13 is a right side elevational view of FIG. 9;

FIG. 14 is a left side elevational view of FIG. 9;

FIG. 15 is a top plan view of third embodiment of FIG. 1;

FIG. 16 is a bottom plan view of FIG. 15;

FIG. 17 is a front elevational view of FIG. 15;

FIG. 18 is a rear elevational view of FIG. 15;

FIG. 19 is a right side elevational view of FIG. 15;

FIG. 20 is a left side elevational view of FIG. 15;

FIG. 21 is a top plan view of a fourth embodiment of FIG. 1;

FIG. 22 is a bottom plan view of FIG. 21;

FIG. 23 is a front elevational view of FIG. 21;

FIG. 24 is a rear elevational view of FIG. 21;

FIG. 25 is a right side elevational view of FIG. 21;

FIG. 26 is a left side elevational of FIG. 21;

FIG. 27 is a top plan view of a fifth embodiment of FIG. 1;

FIG. 28 is a bottom plan view of FIG. 27;

FIG. 29 is a front elevational view of FIG. 27;

FIG. 30 is a rear elevational view of FIG. 27;

FIG. 31 is a right side elevational view of FIG. 27;

FIG. 32 is a left side elevational view of FIG. 27;

FIG. 33 is a top plan view of a sixth embodiment of FIG. 1;

FIG. 34 is a bottom plan view of FIG. 33;

FIG. 35 is a front elevational view of FIG. 33;

FIG. 36 is a rear elevational view of FIG. 33;

FIG. 37 is a right side elevational view of FIG. 33;

FIG. 38 is a left side elevational view of FIG. 33;

FIG. 39 is a perspective view of a seventh embodiment of FIG. 1;

FIG. 40 is a bottom perspective view fo FIG. 39 showing sides undisclosed in FIG. 39;

FIG. 41 is a top plan view of FIG. 39;

FIG. 42 is a bottom plan view of FIG. 39;

FIG. 43 is a front elevational view of FIG. 39; and,

FIG. 44 is a rear elevational view of FIG. 39.

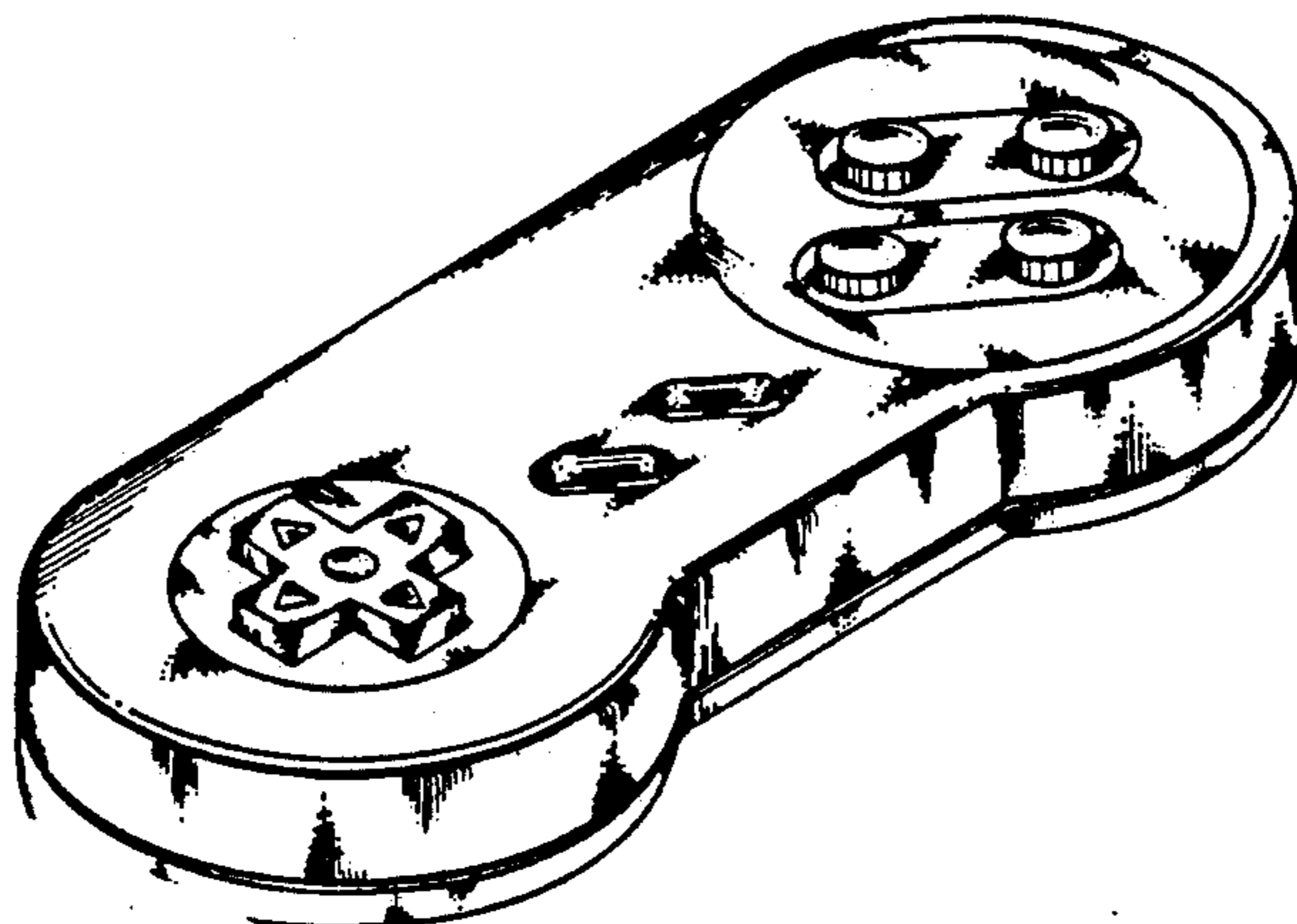

FIG. 1

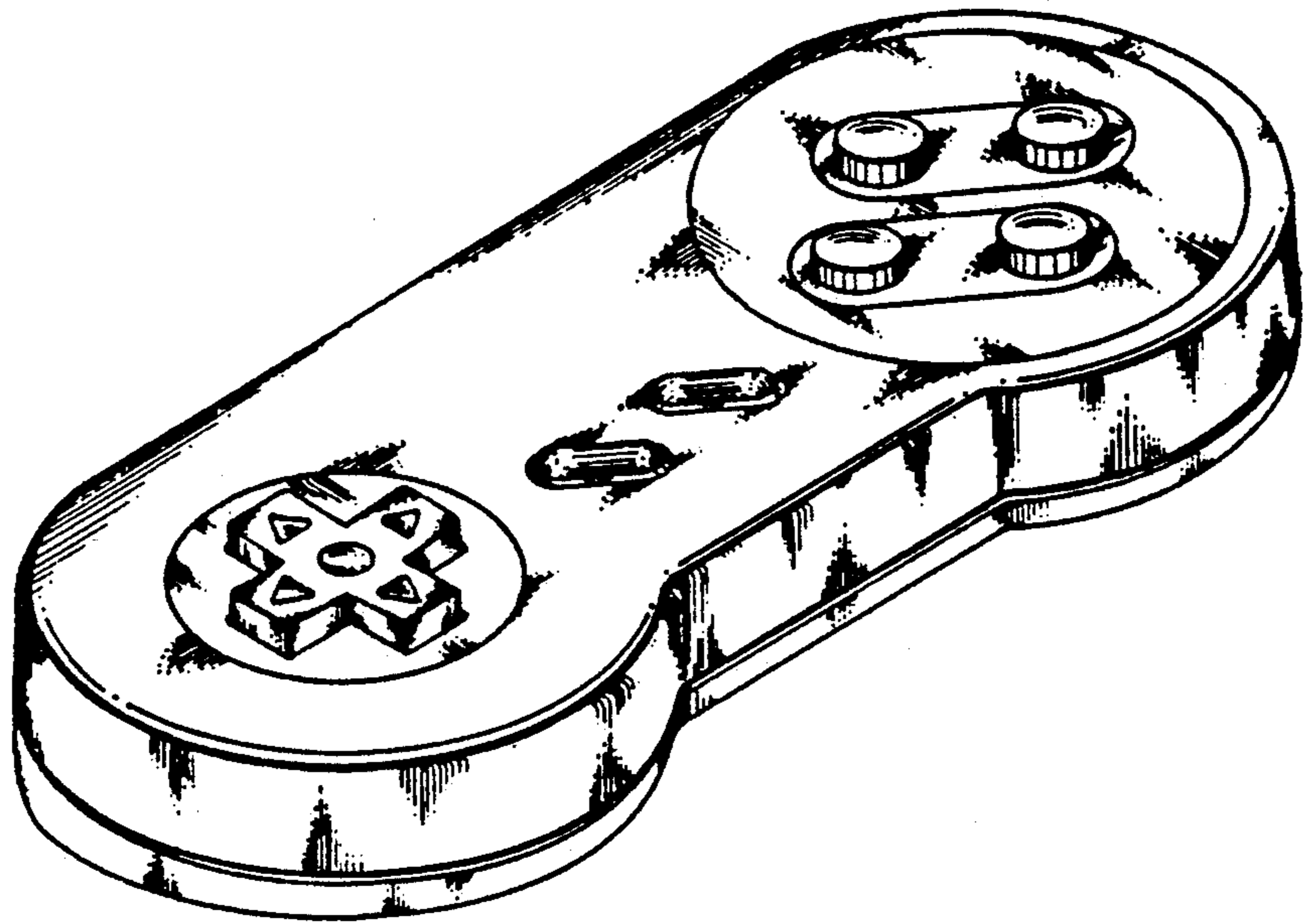

FIG. 2

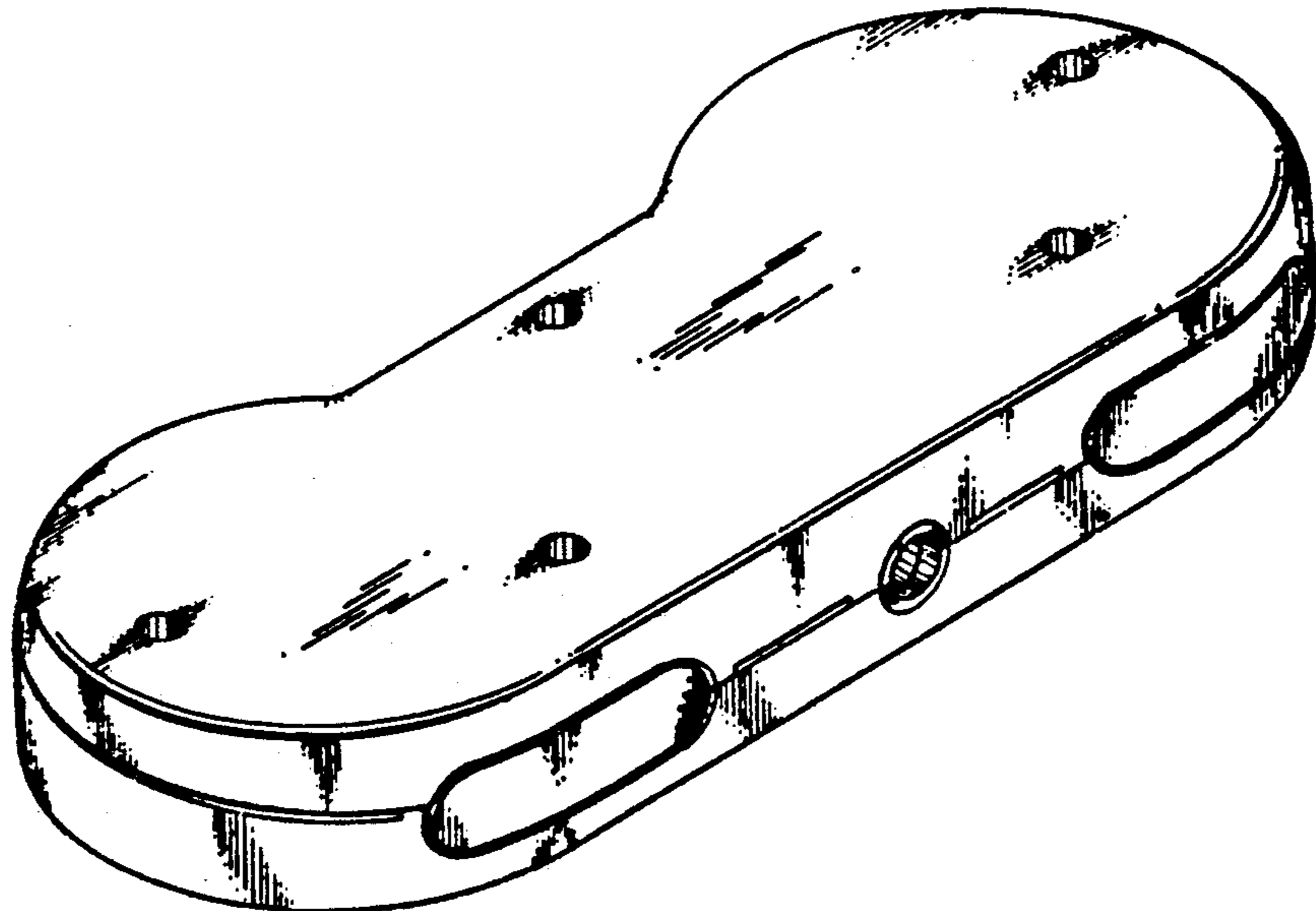

FIG. 3

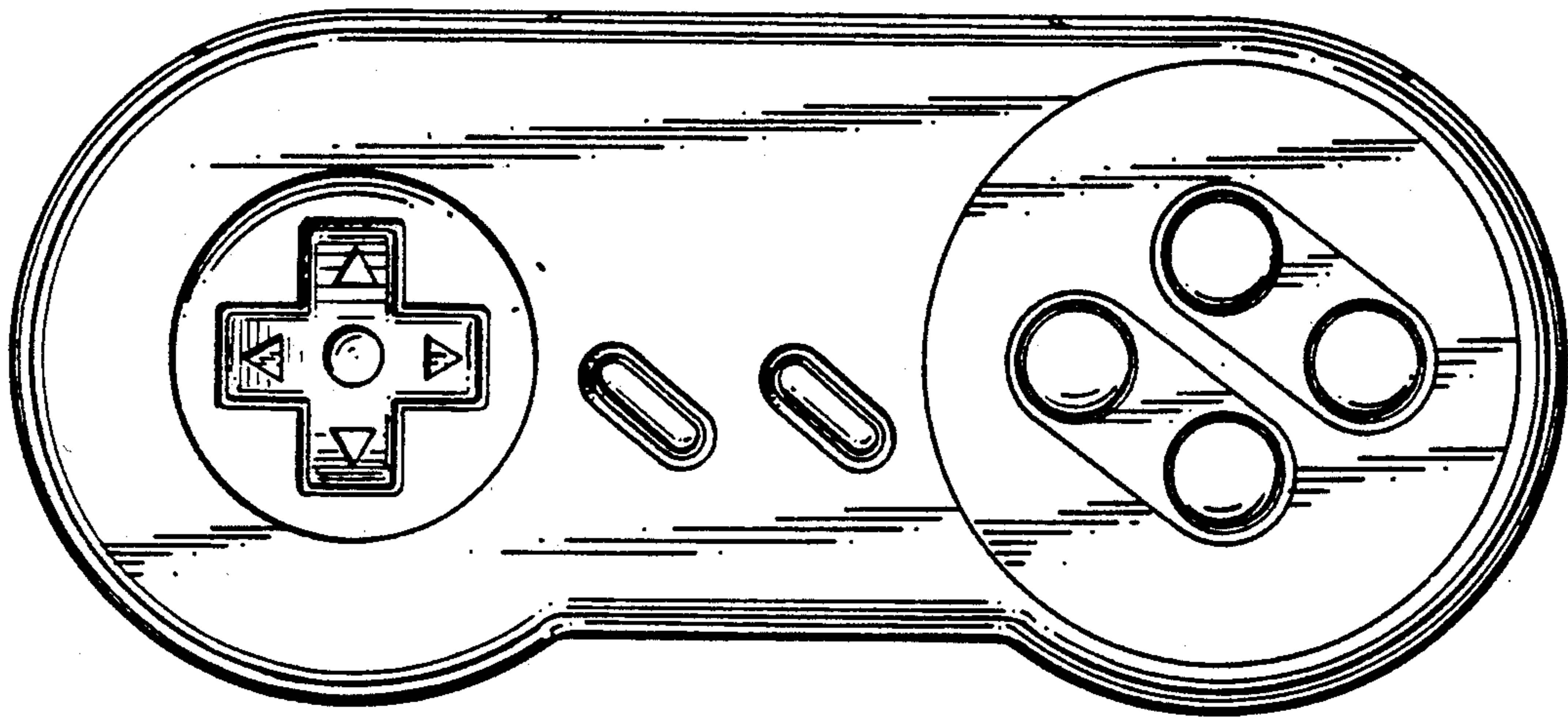

FIG. 4

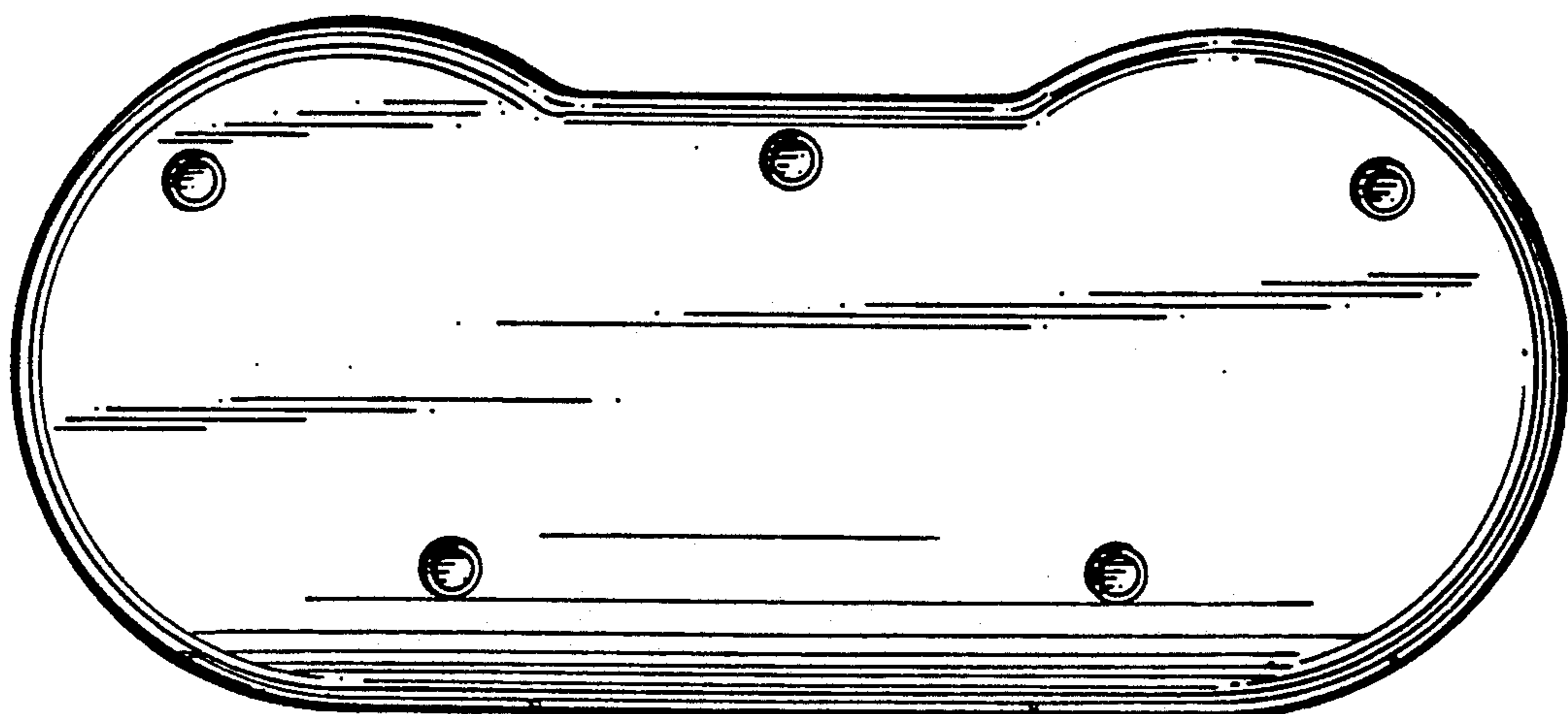

FIG. 5

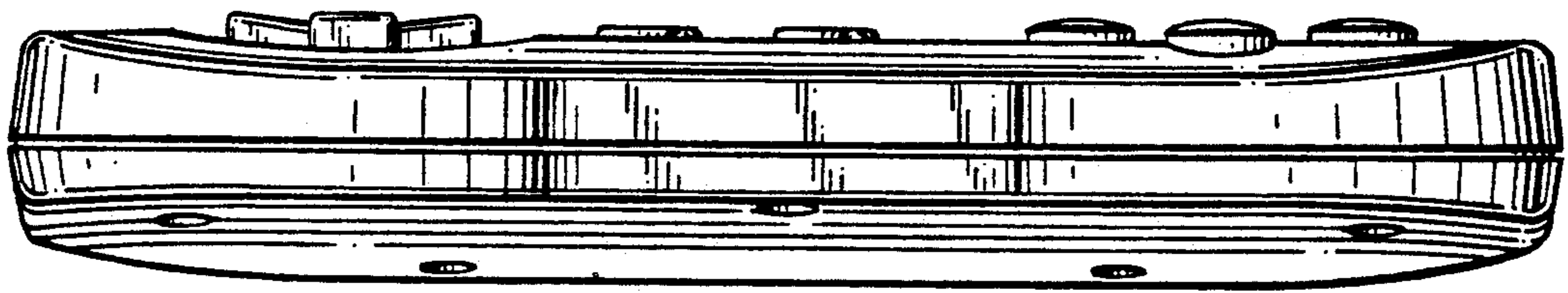

FIG. 6

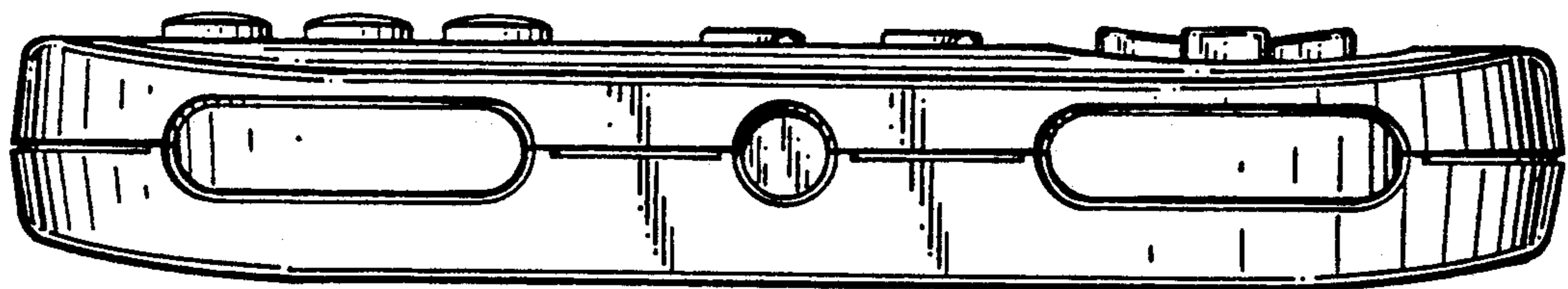

FIG. 7

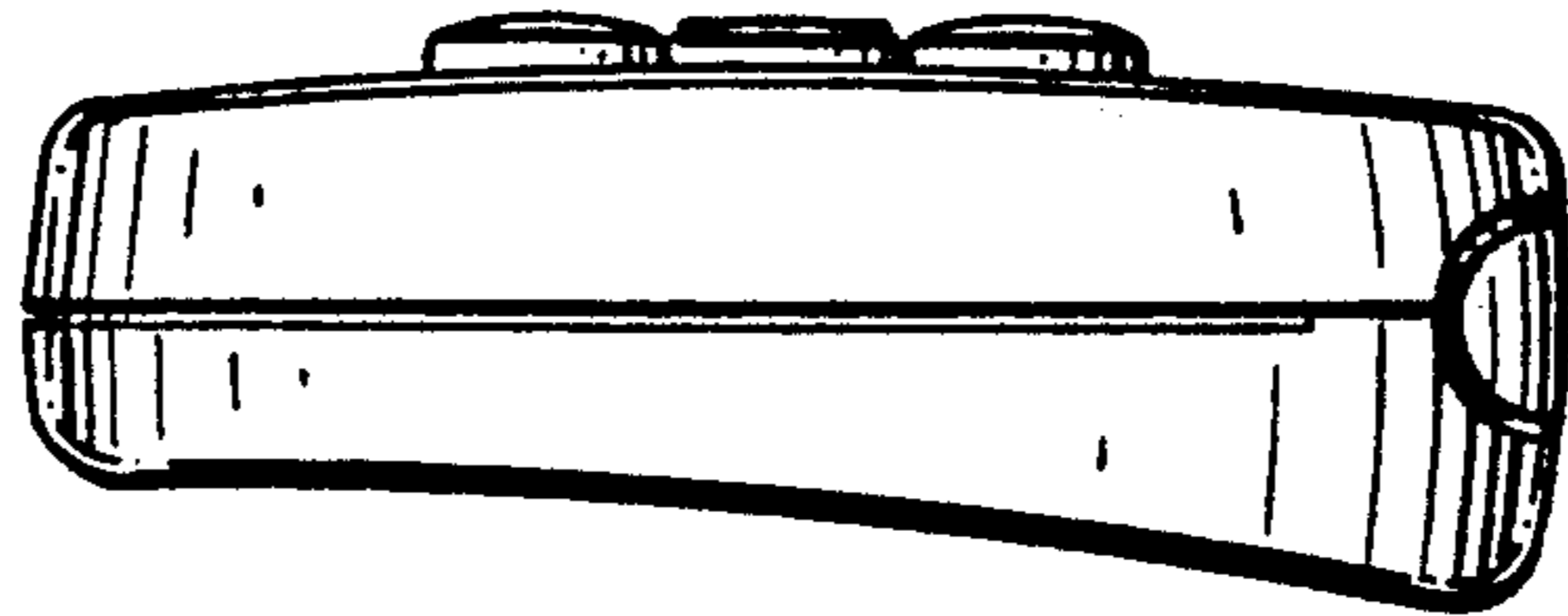

FIG. 8

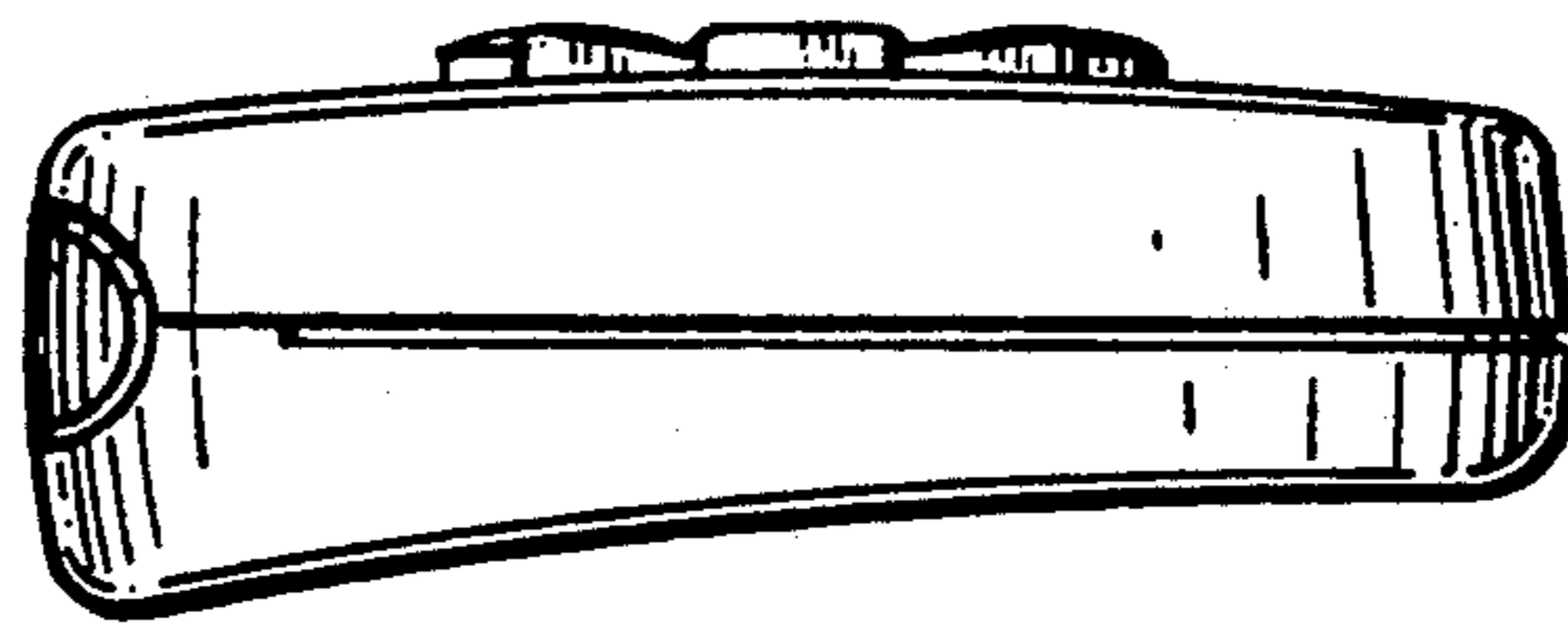

FIG. 9

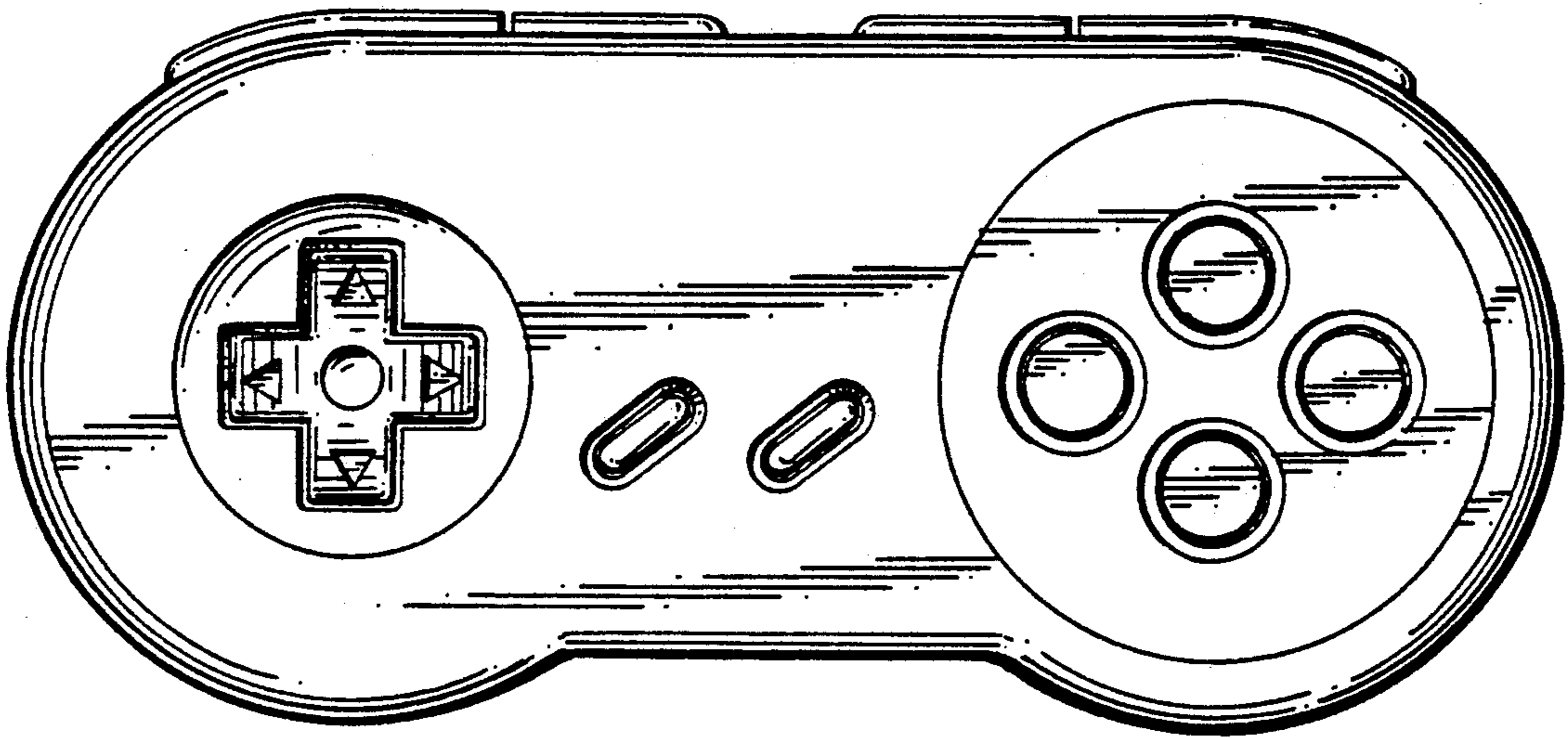

FIG. 10

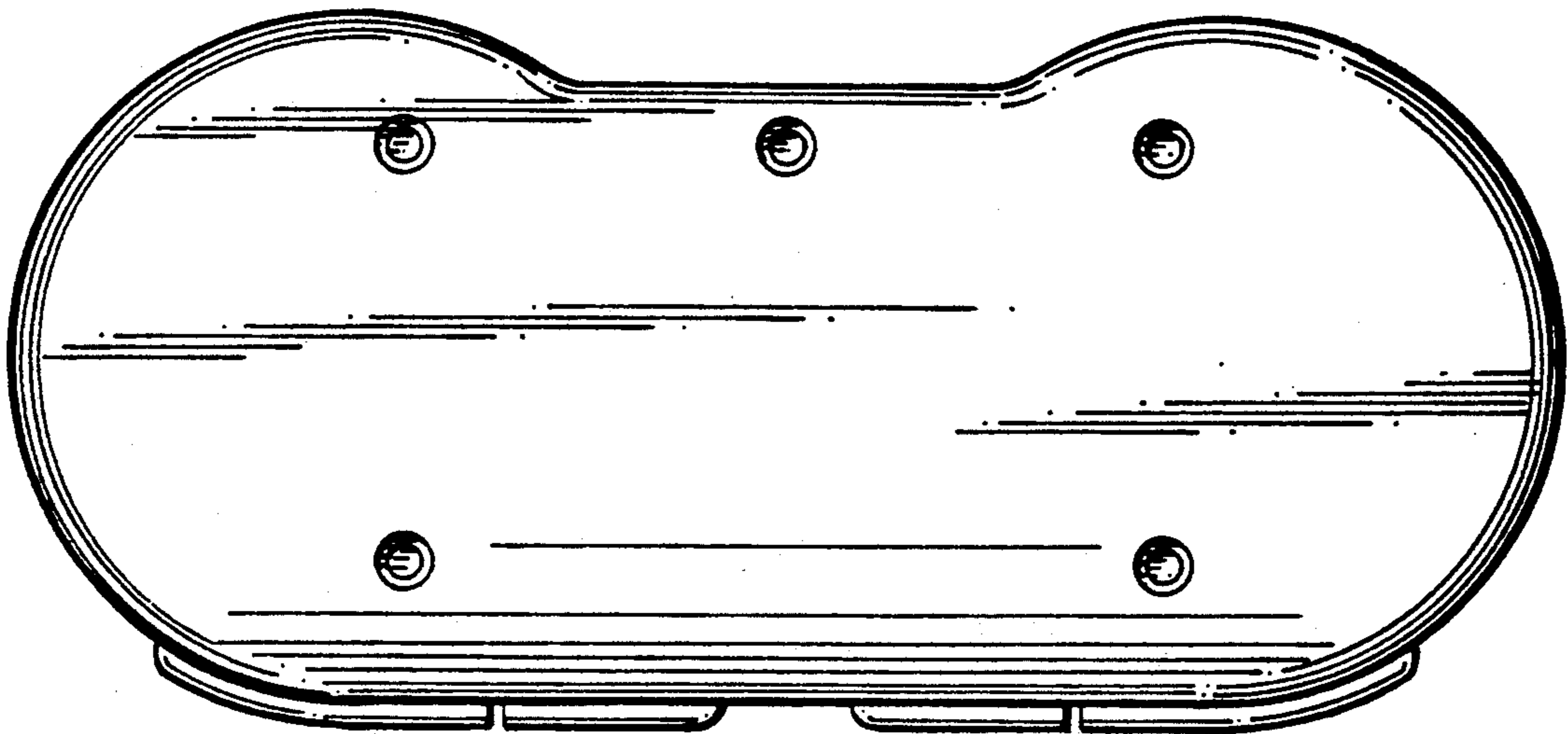

FIG. 11

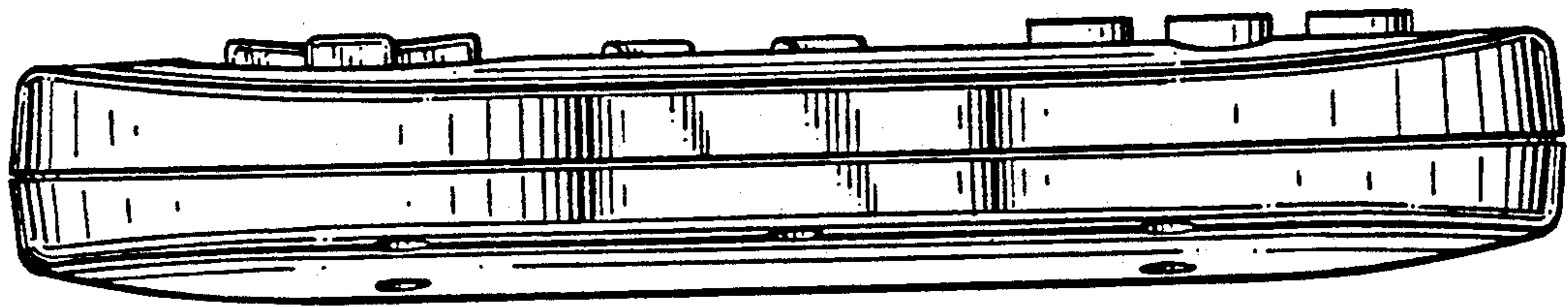

FIG. 12

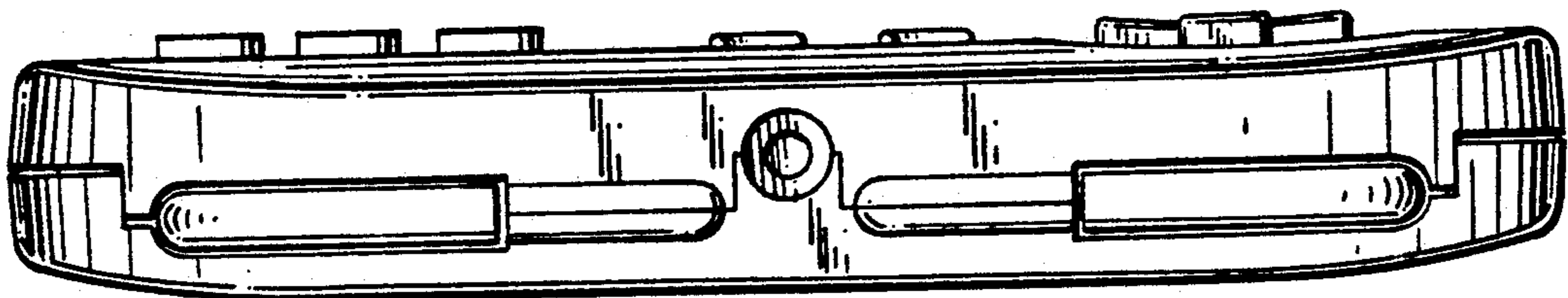

FIG. 13

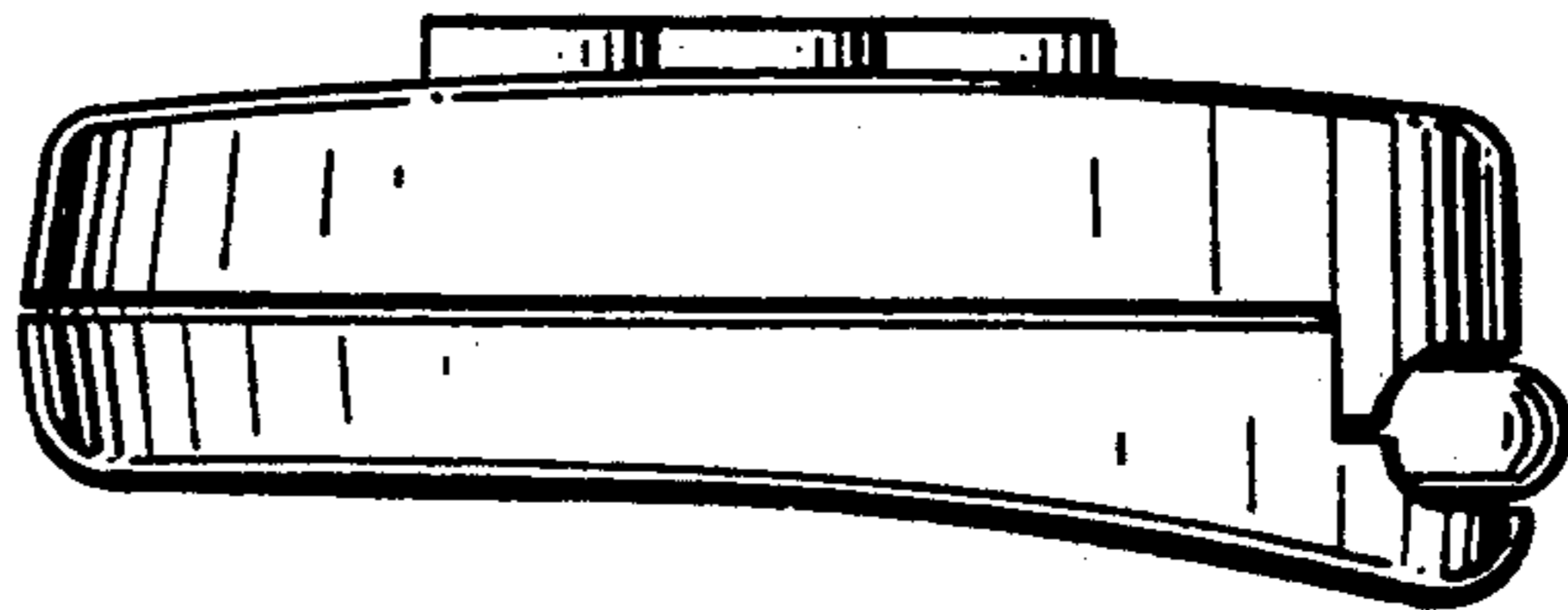

FIG. 14

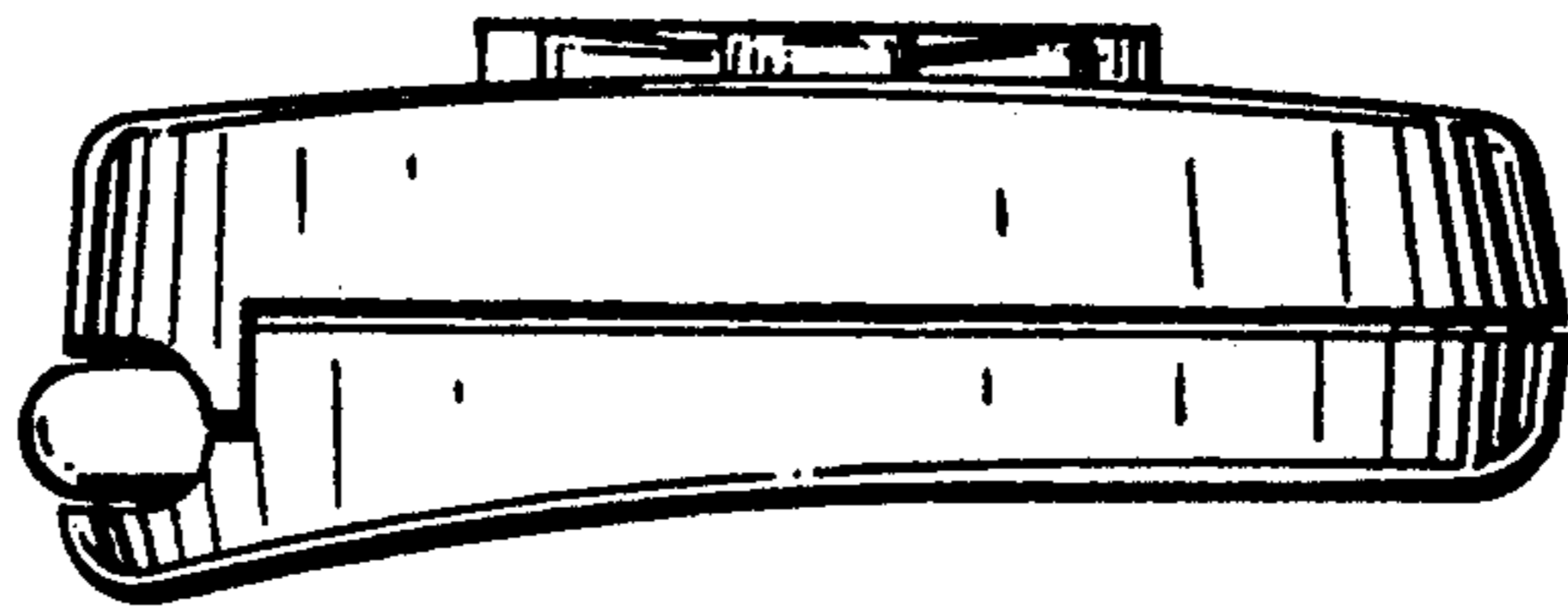

FIG. 15

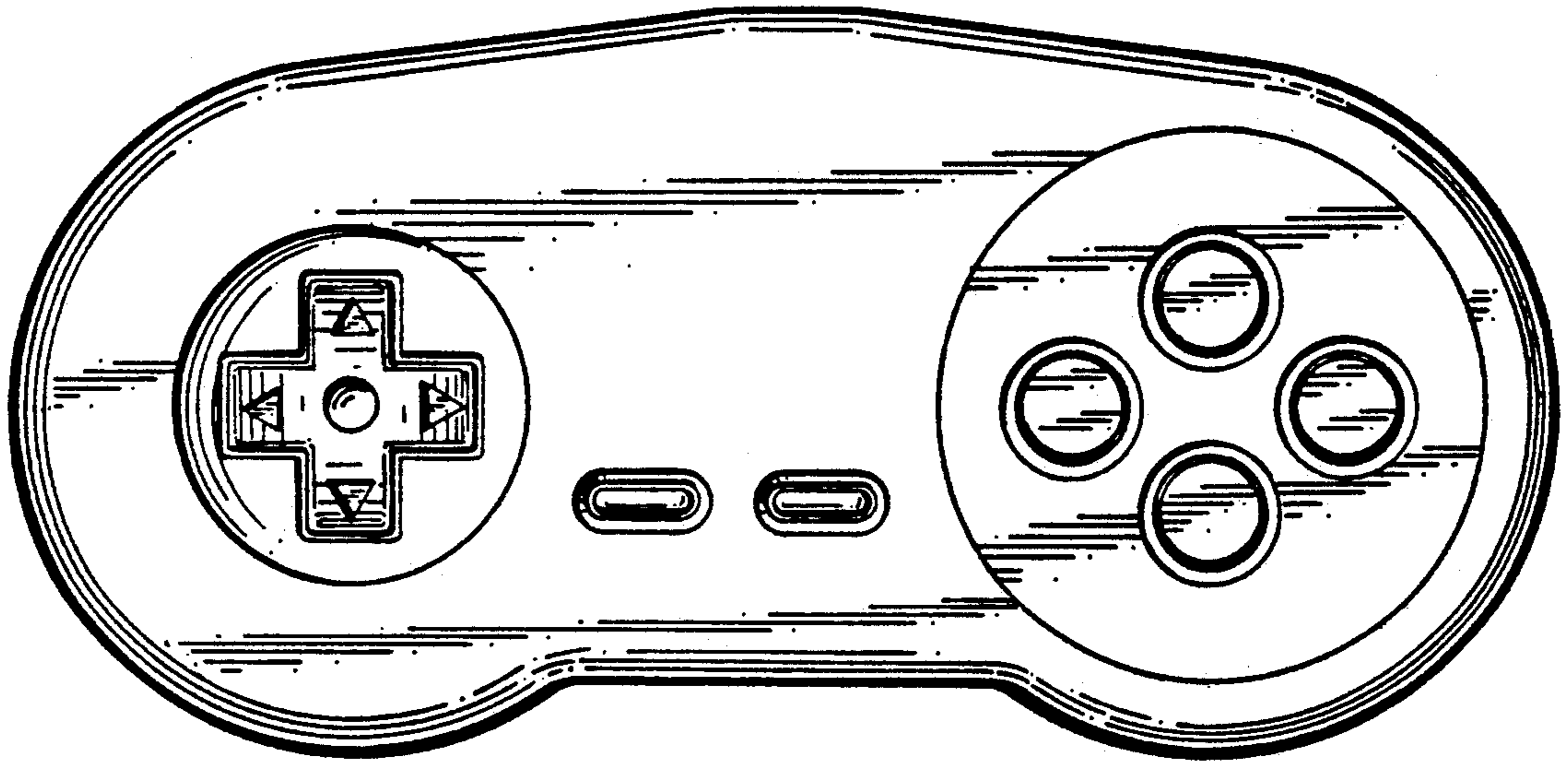

FIG. 16

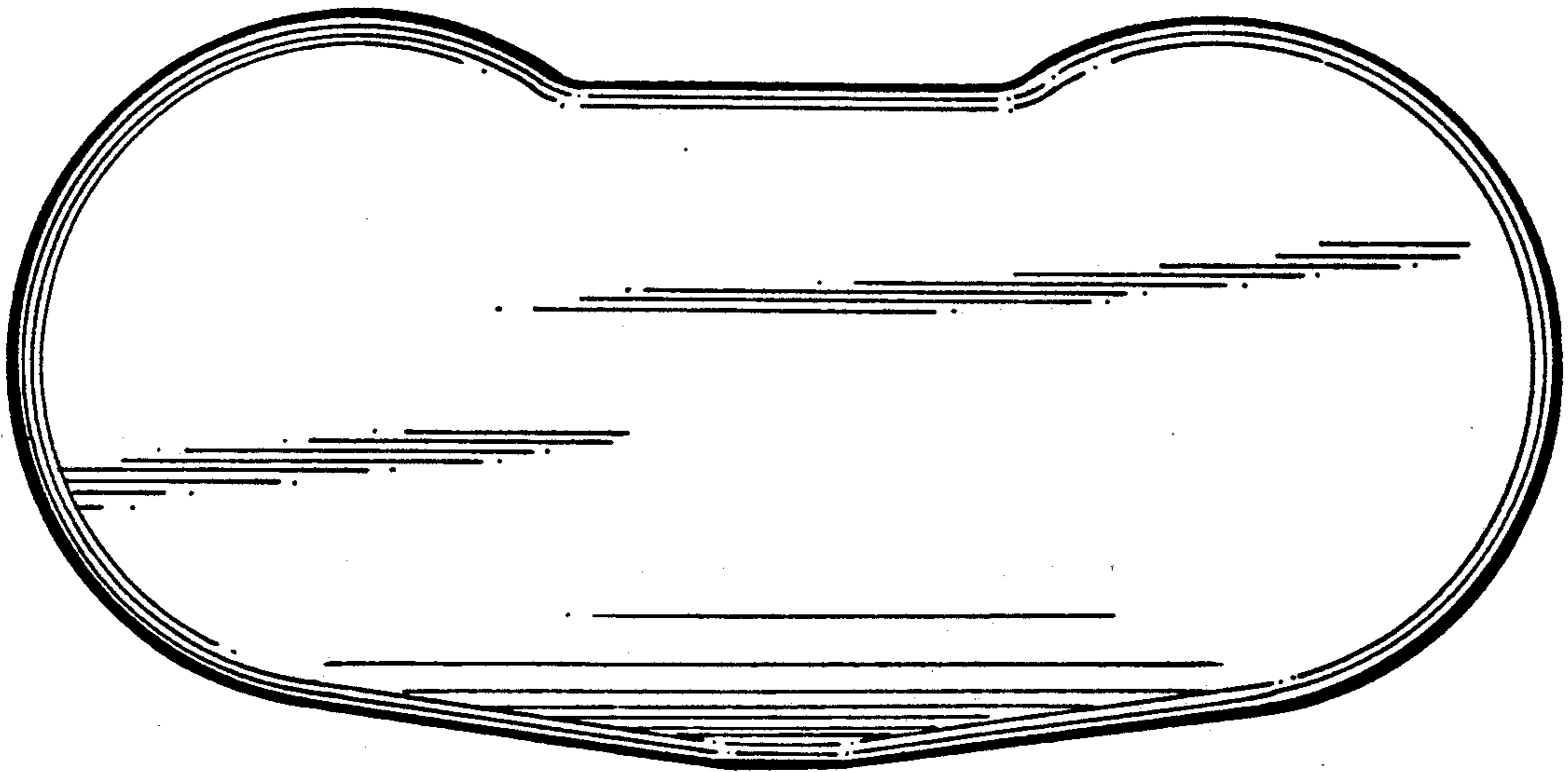

FIG. 17

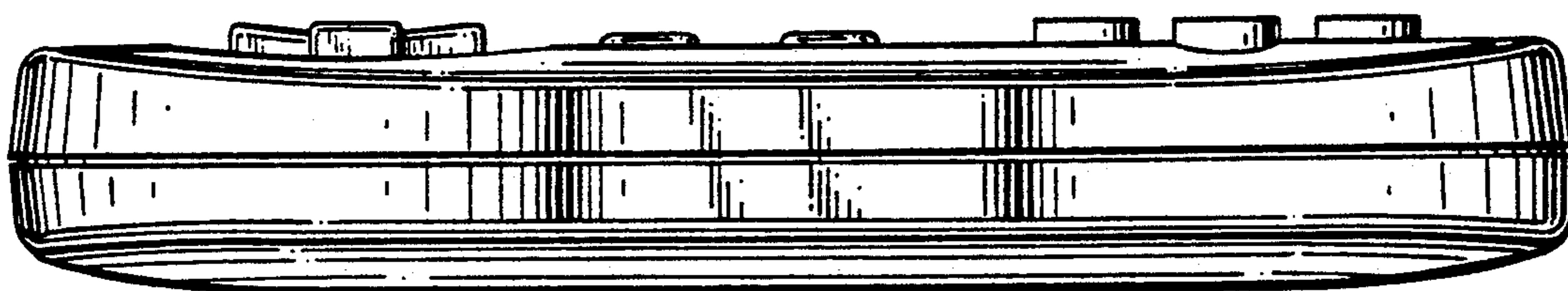

FIG. 18

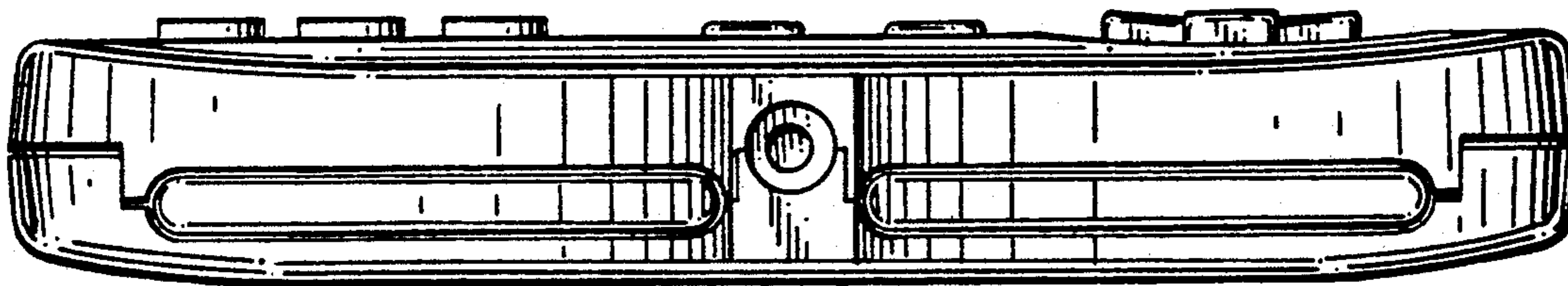

FIG. 19

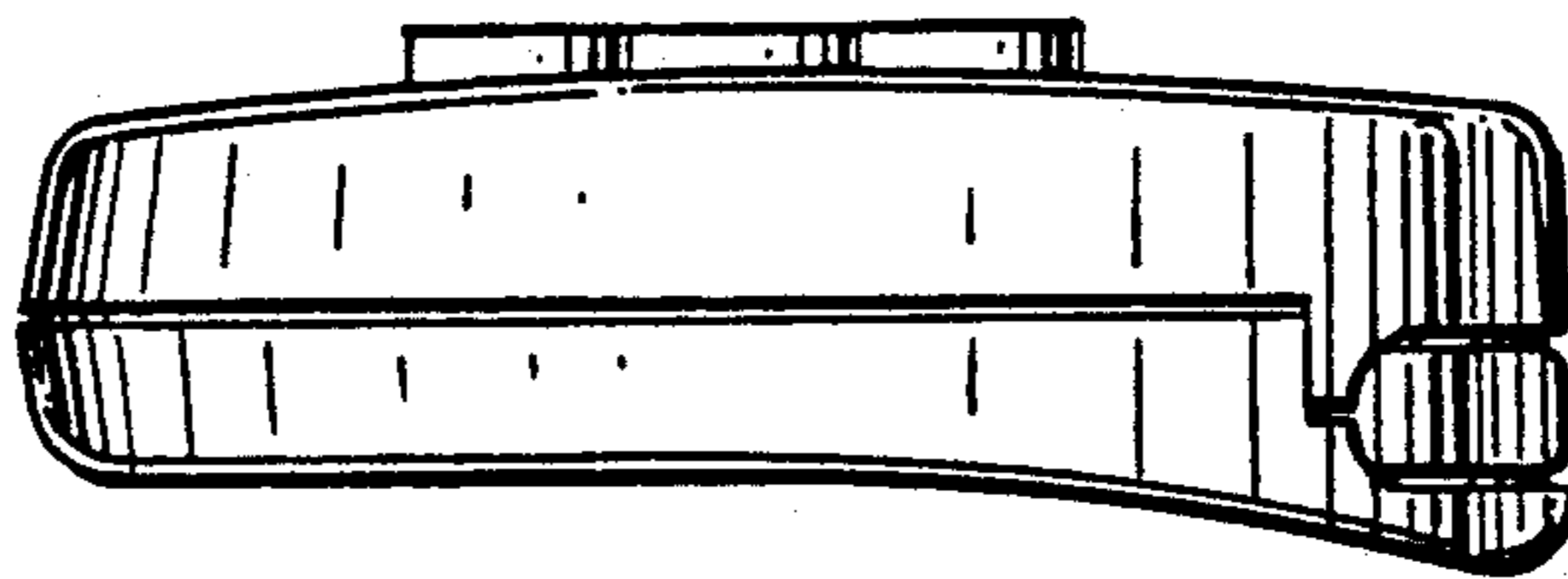

FIG. 20

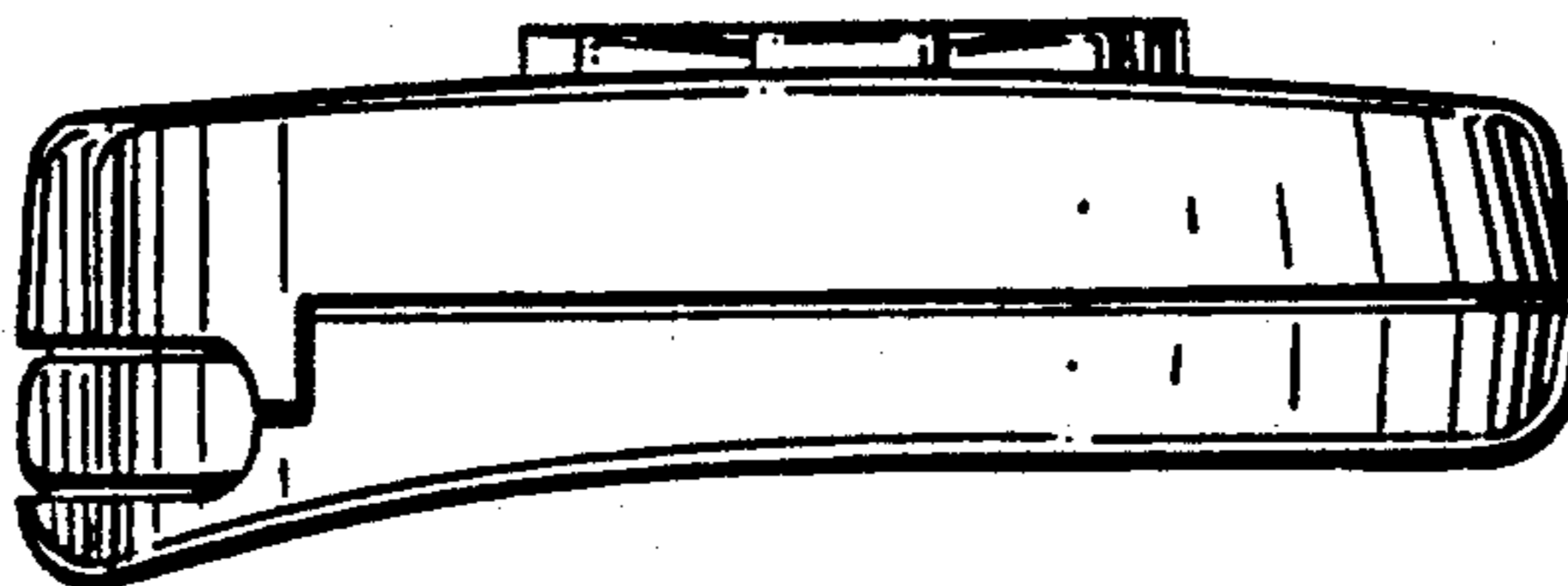

FIG. 21

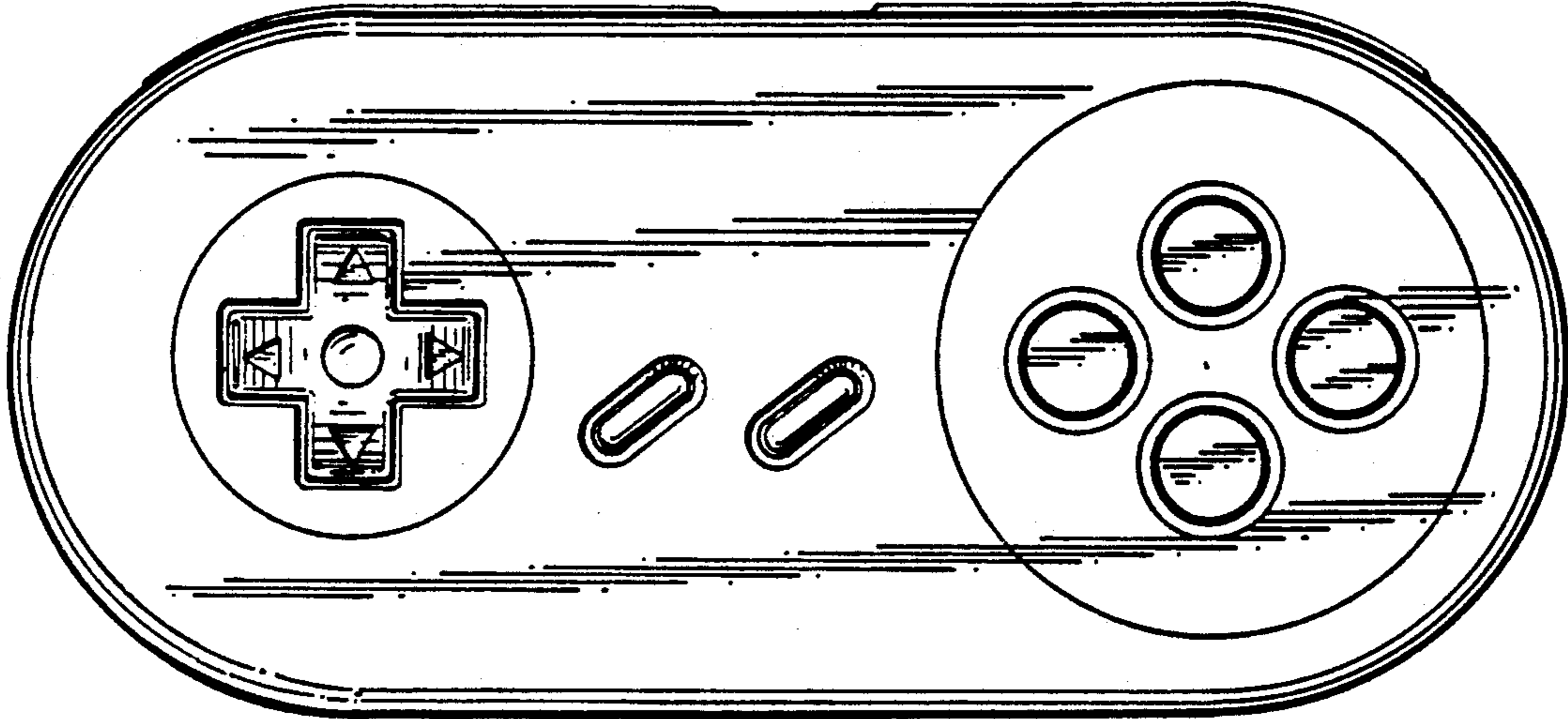

FIG. 22

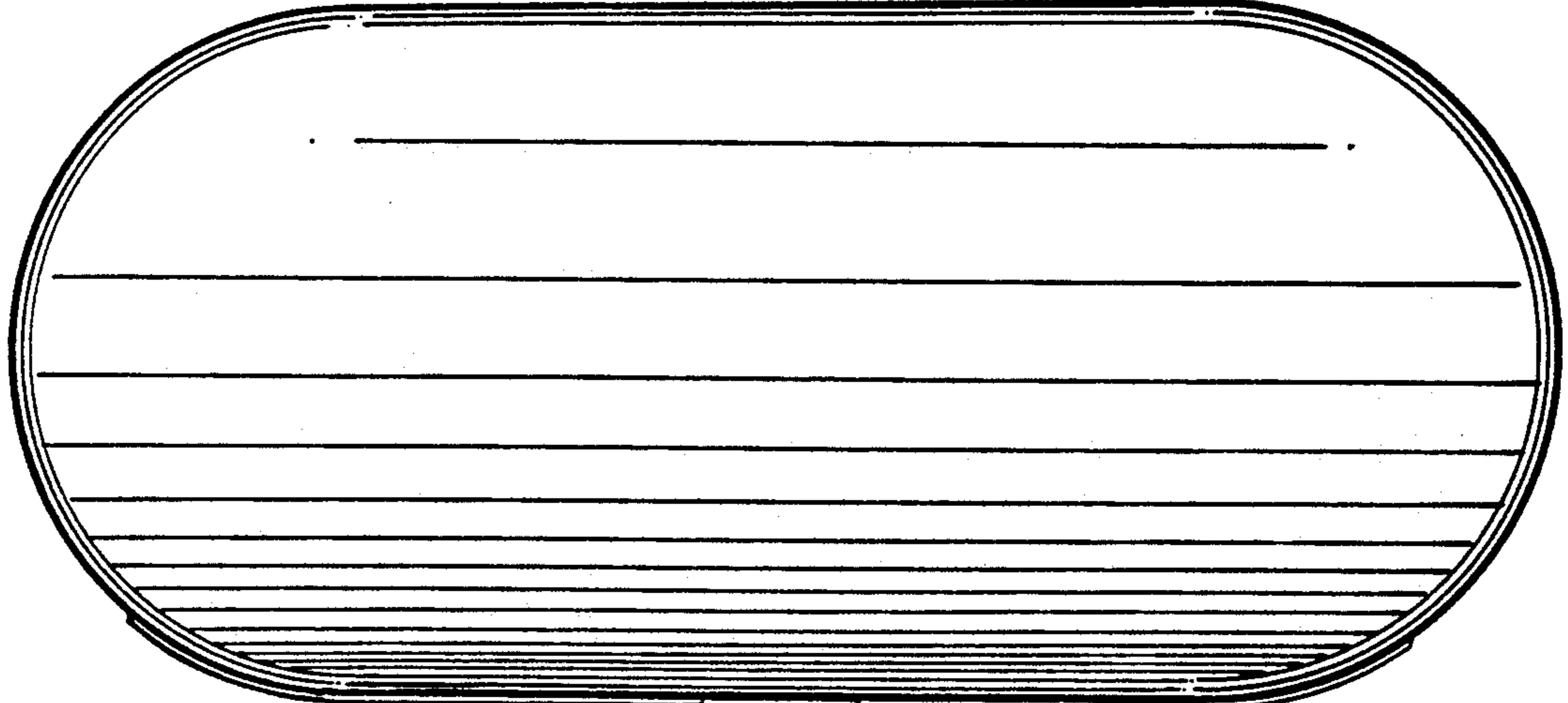

FIG. 23

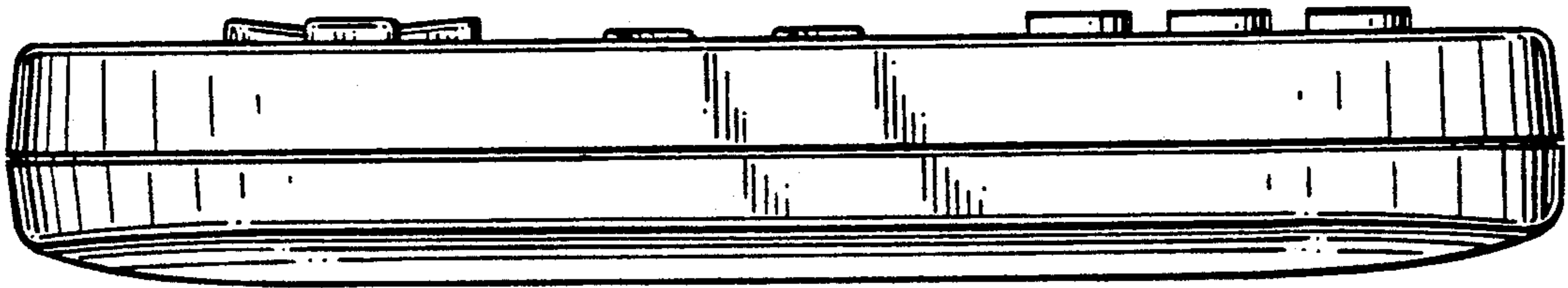

FIG. 24

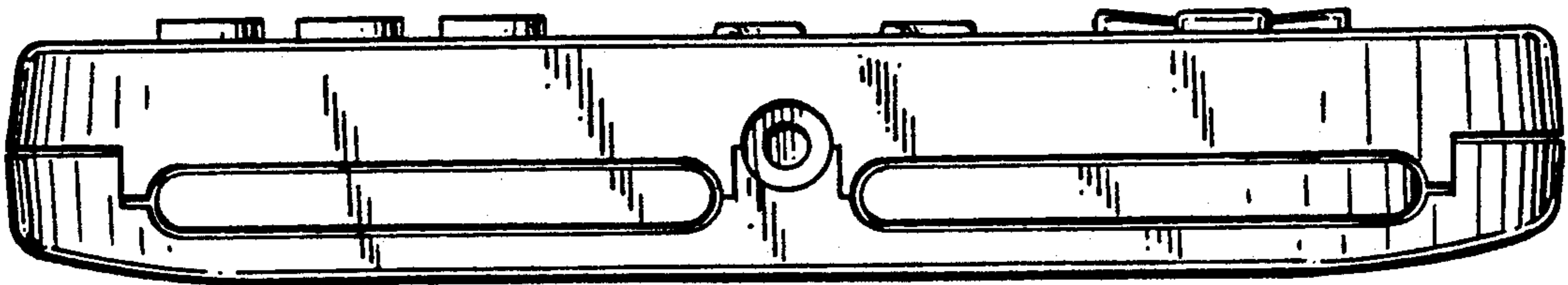

FIG. 25

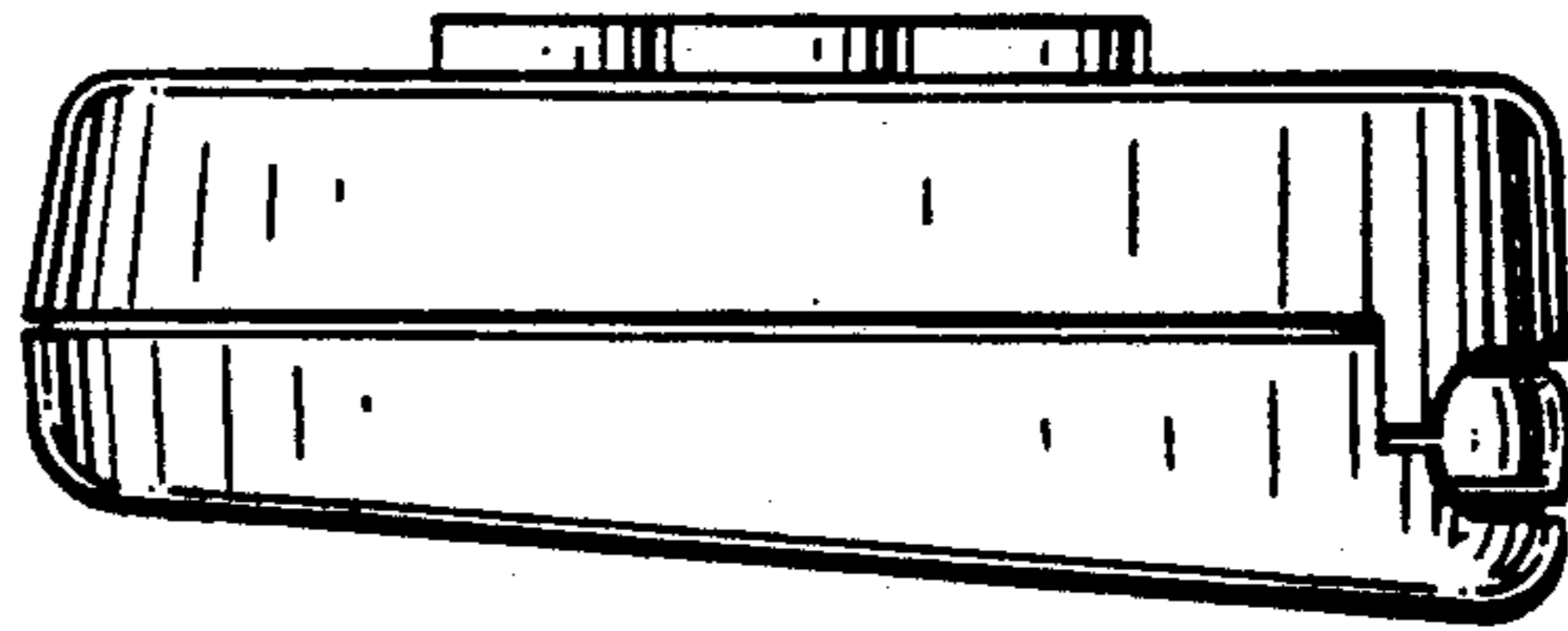

FIG. 26

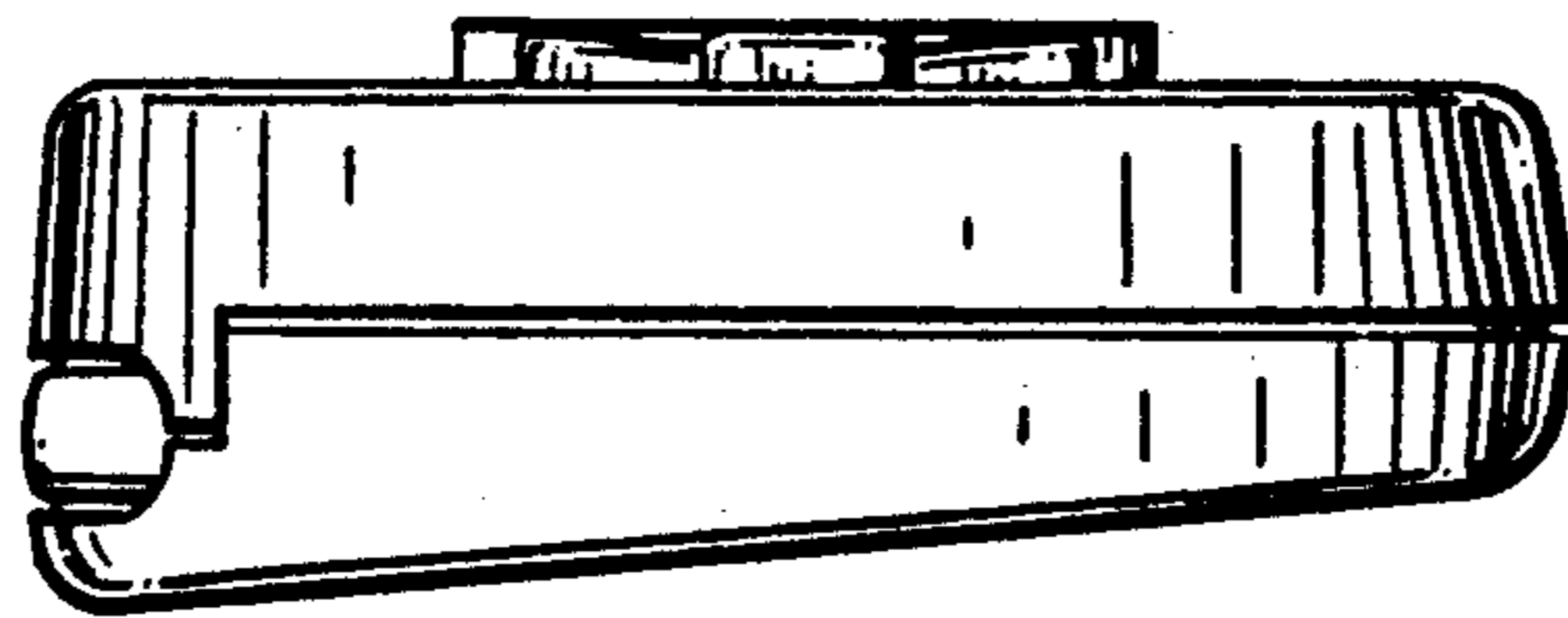

FIG. 27

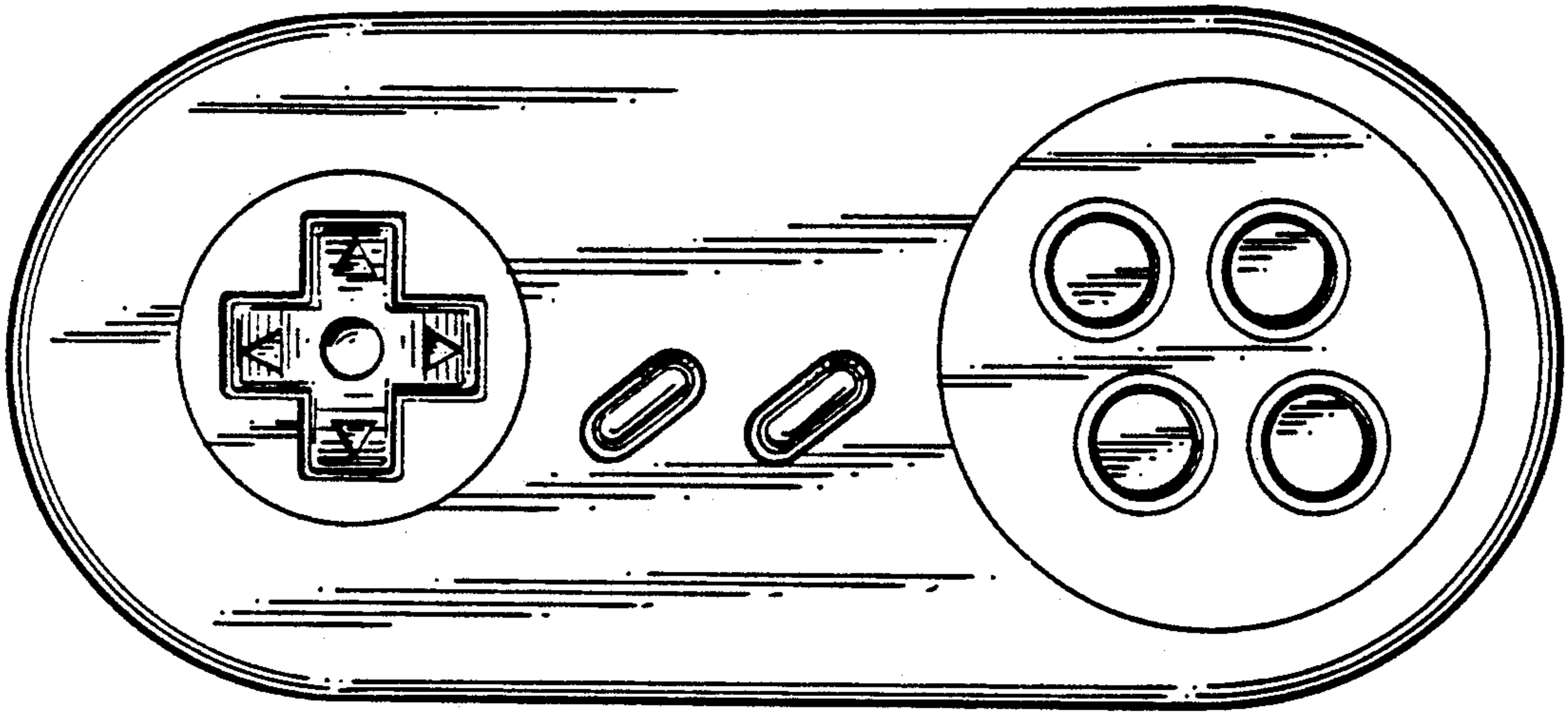

FIG. 28

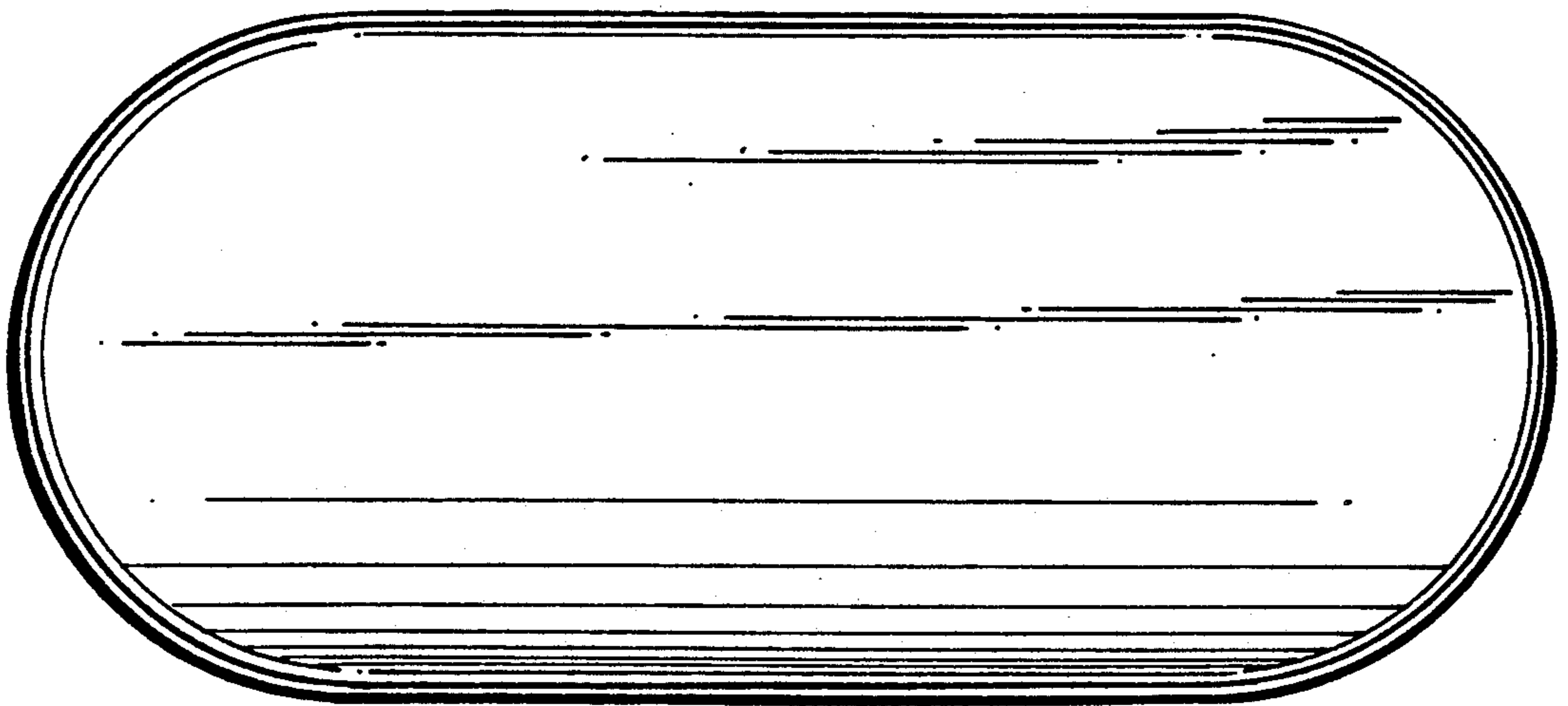

FIG. 29

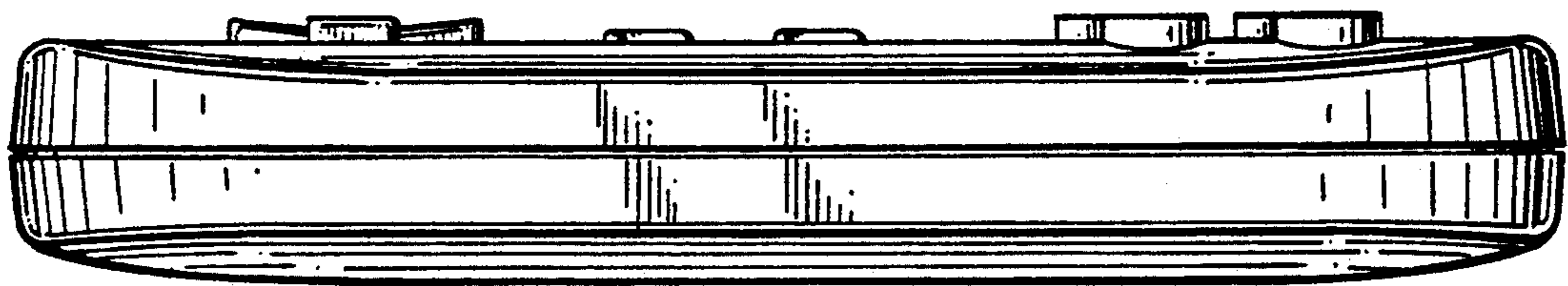

FIG. 30

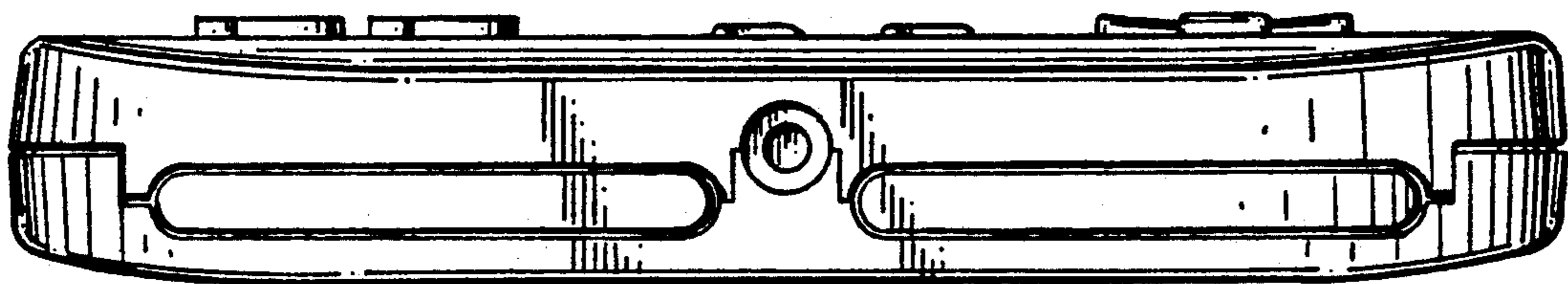

FIG. 31

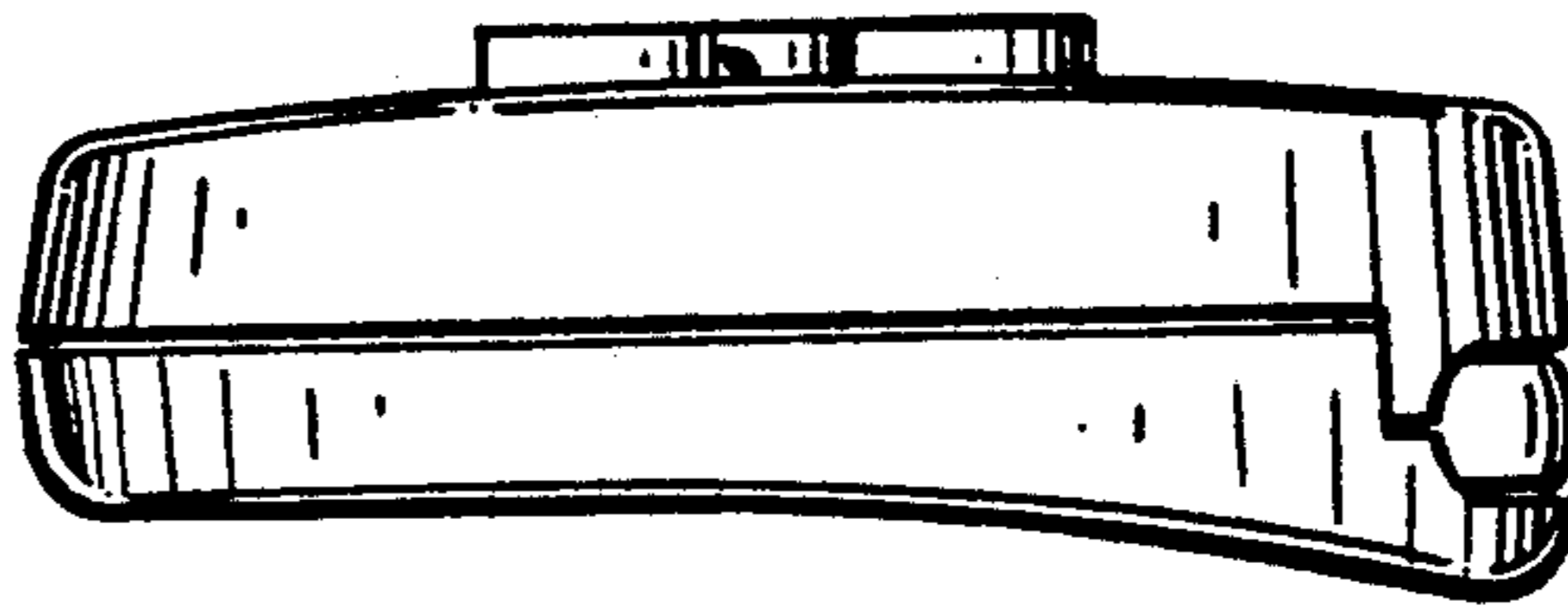

FIG. 32

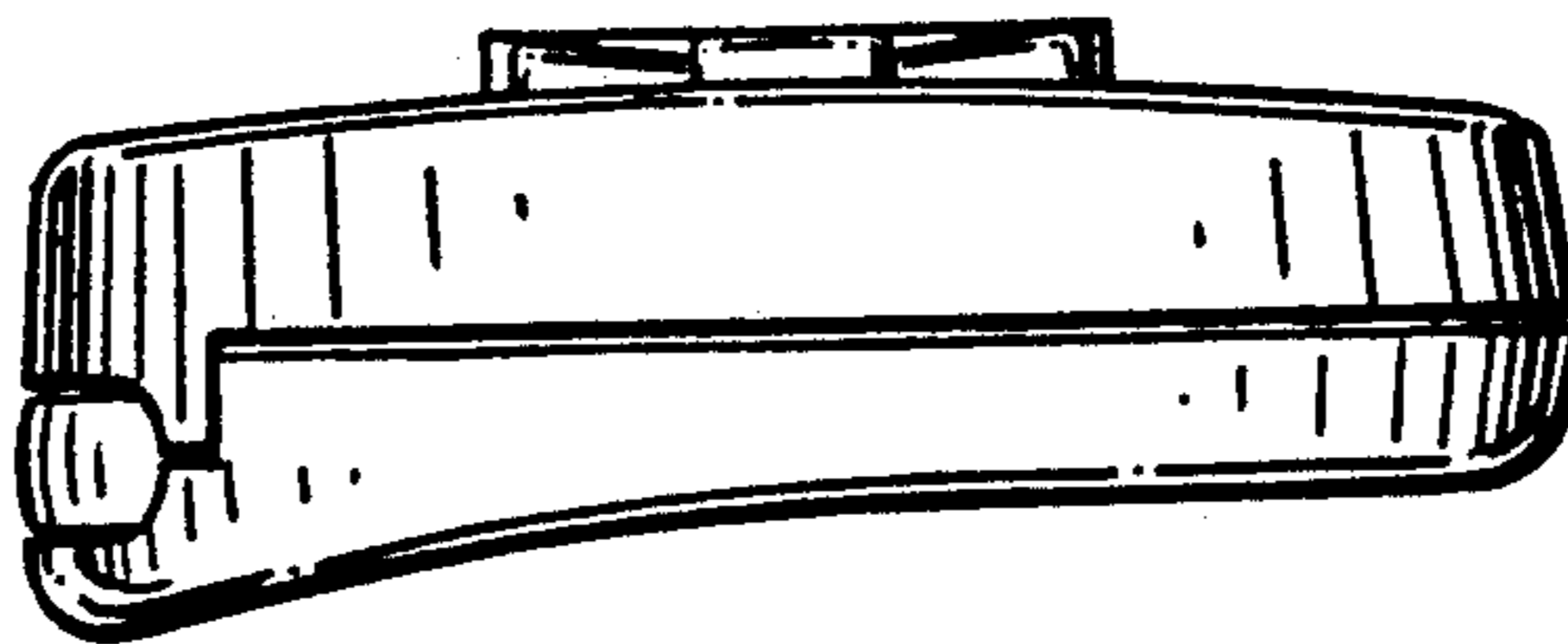

FIG. 33

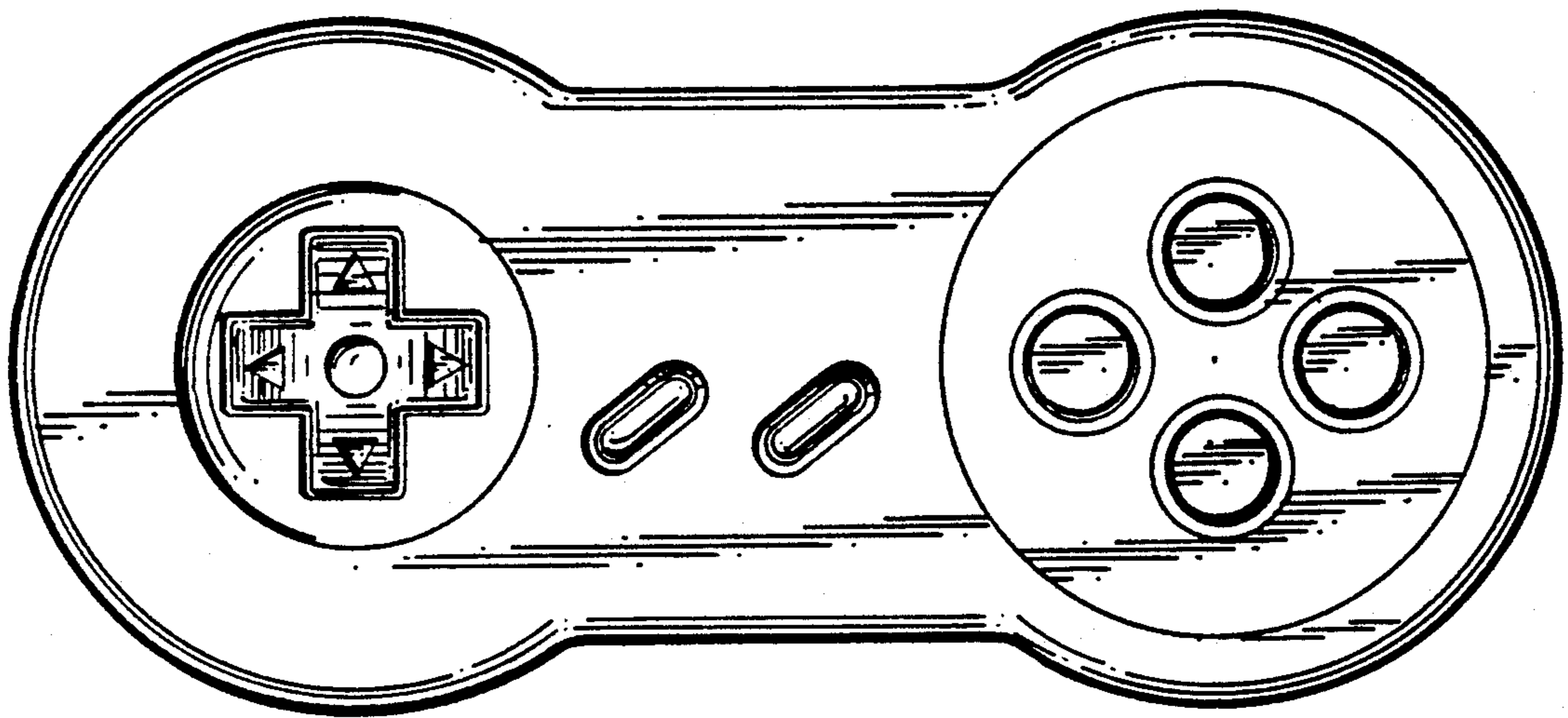

FIG. 34

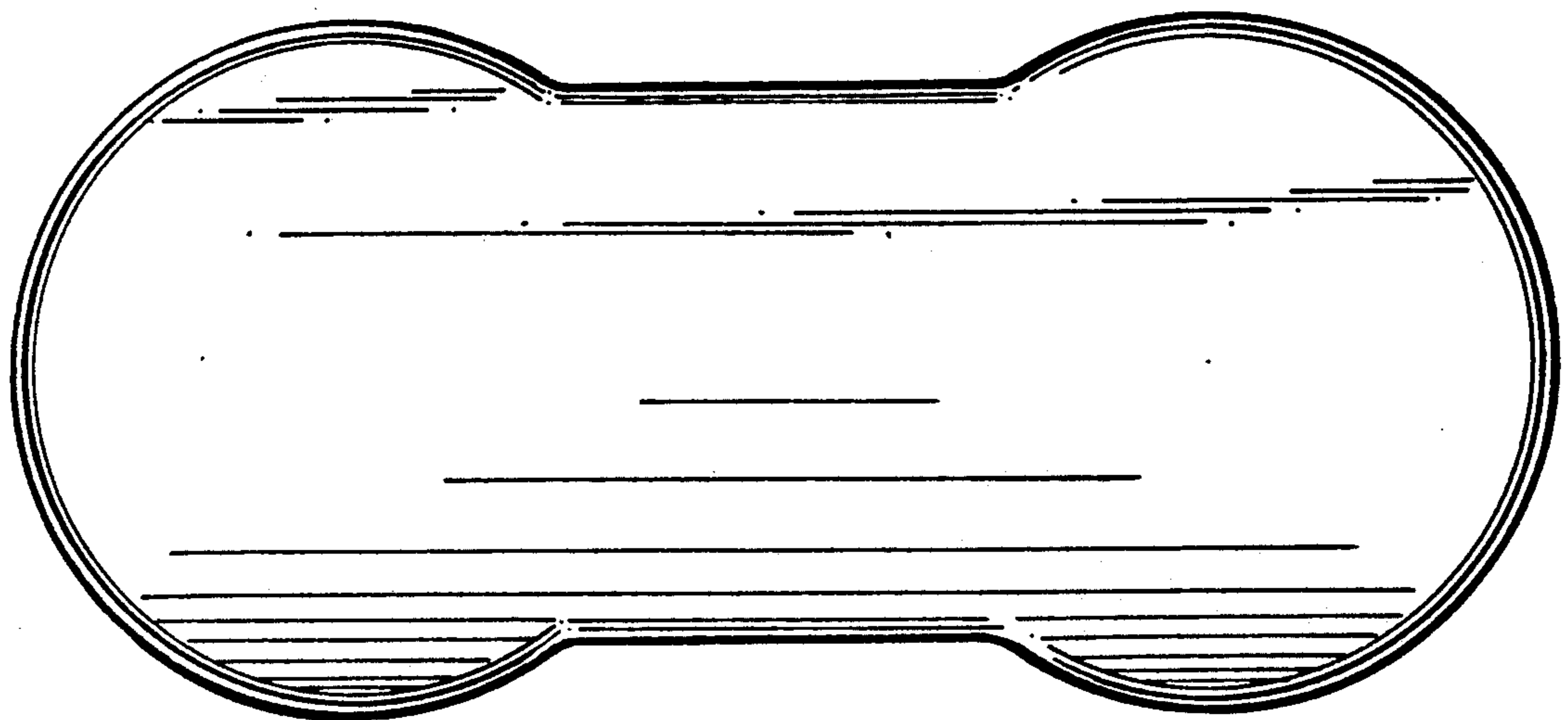

FIG. 35

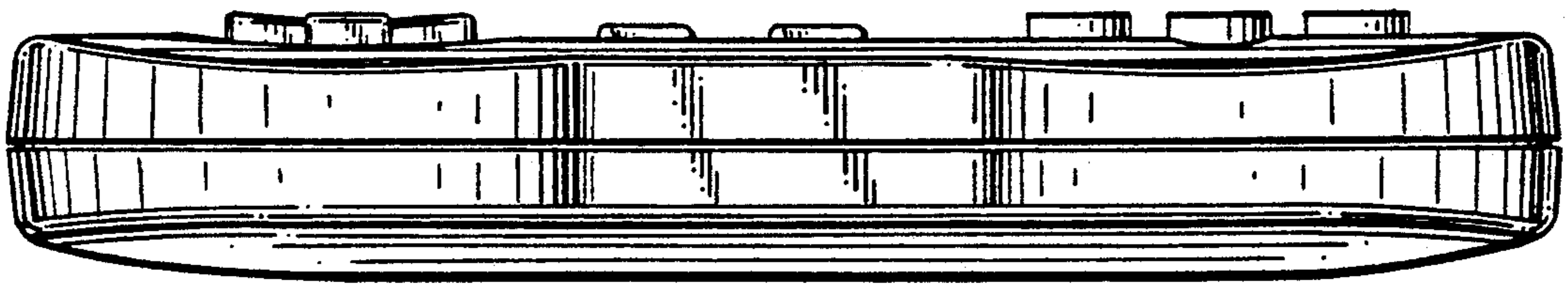

FIG. 36

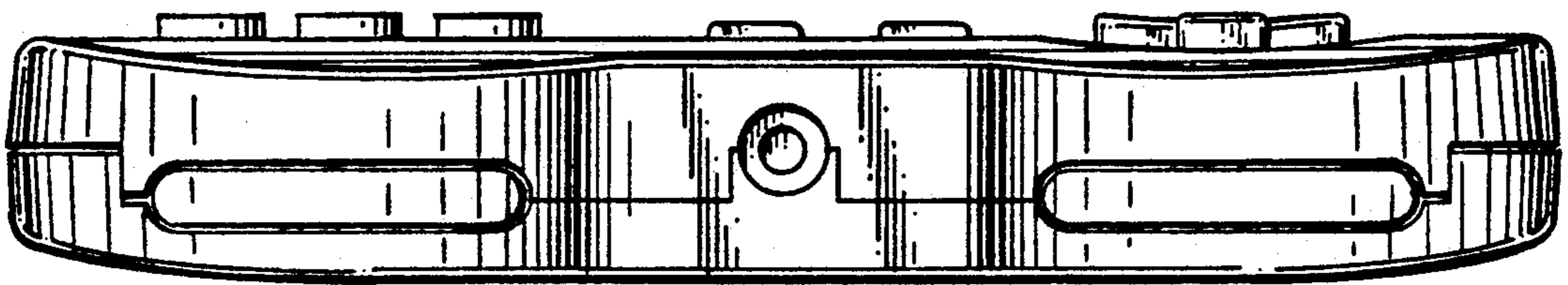

FIG. 37

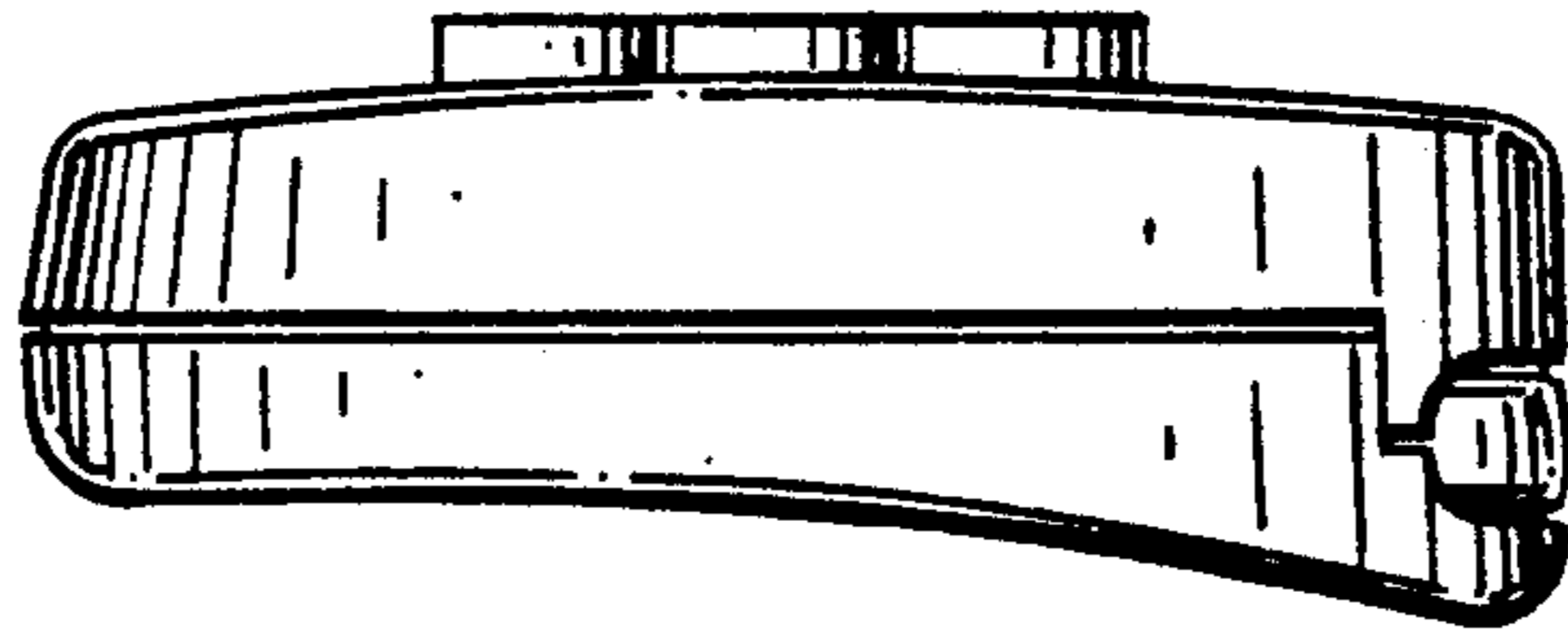

FIG. 38

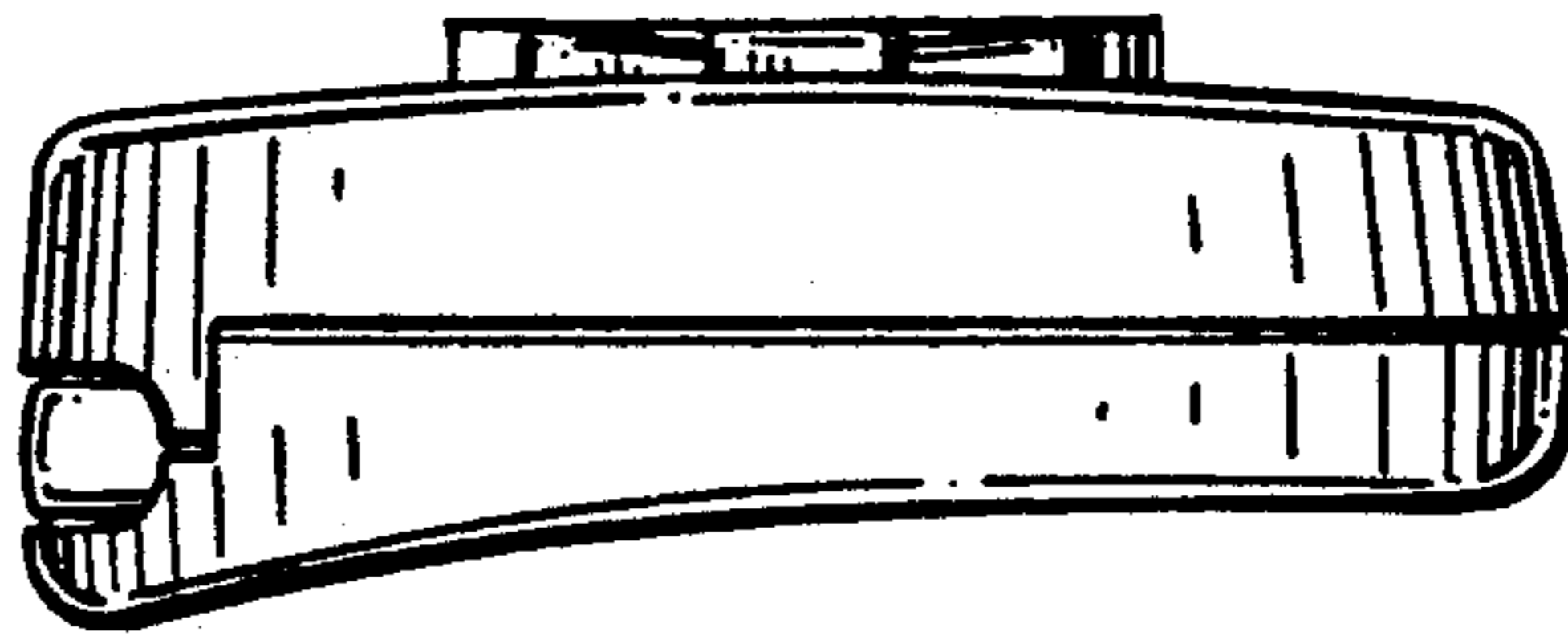

FIG. 39

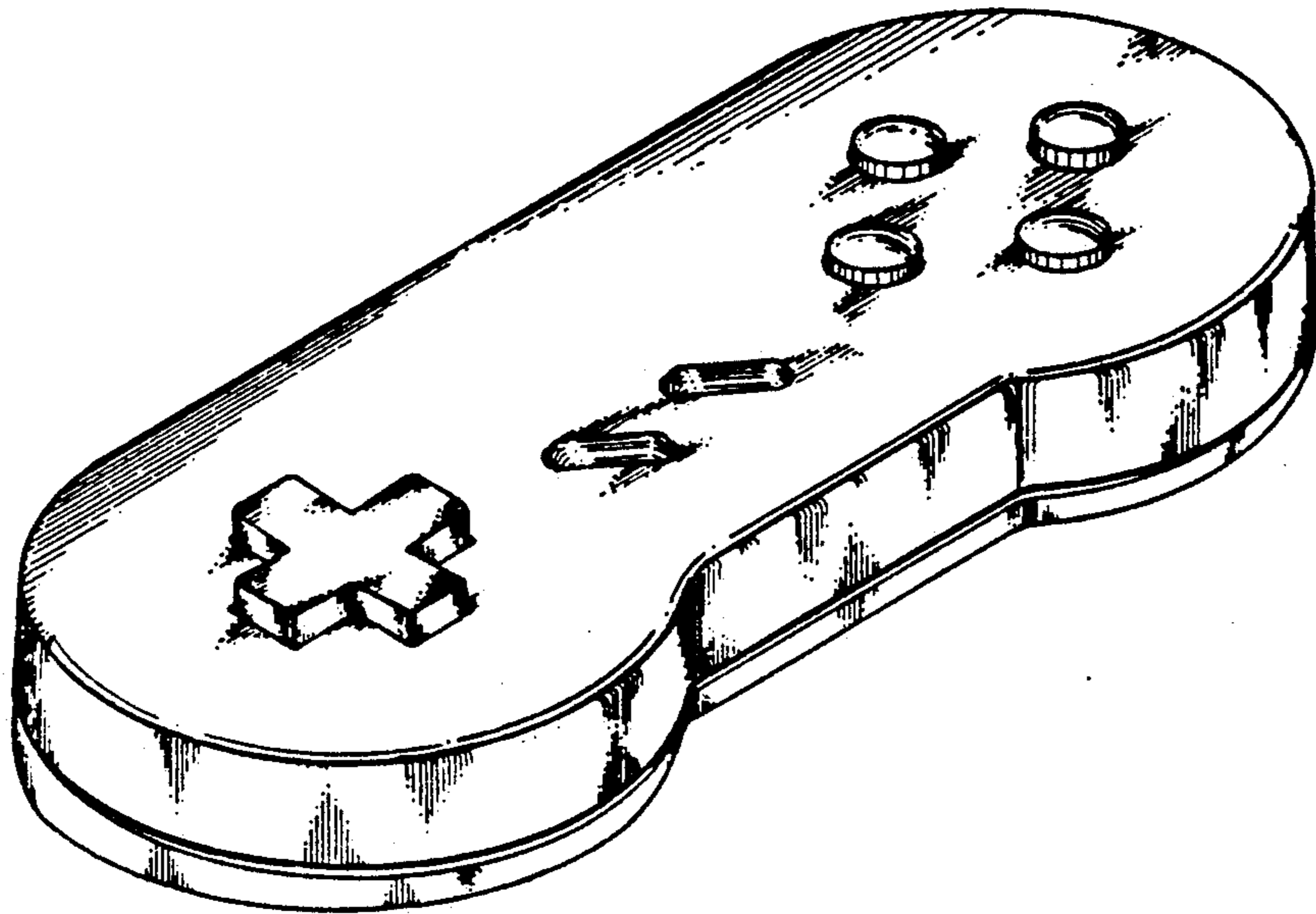

FIG. 40

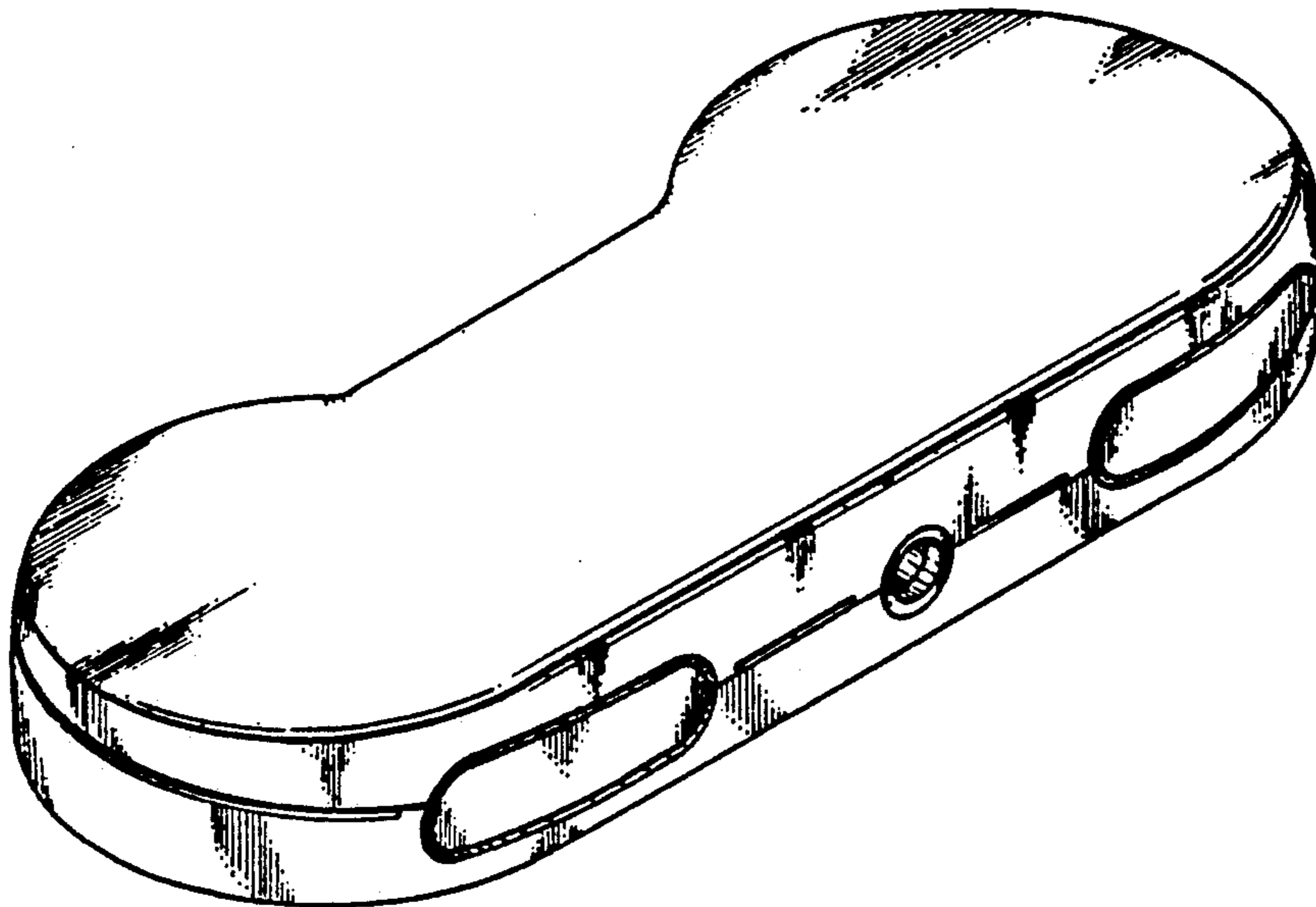

FIG. 41

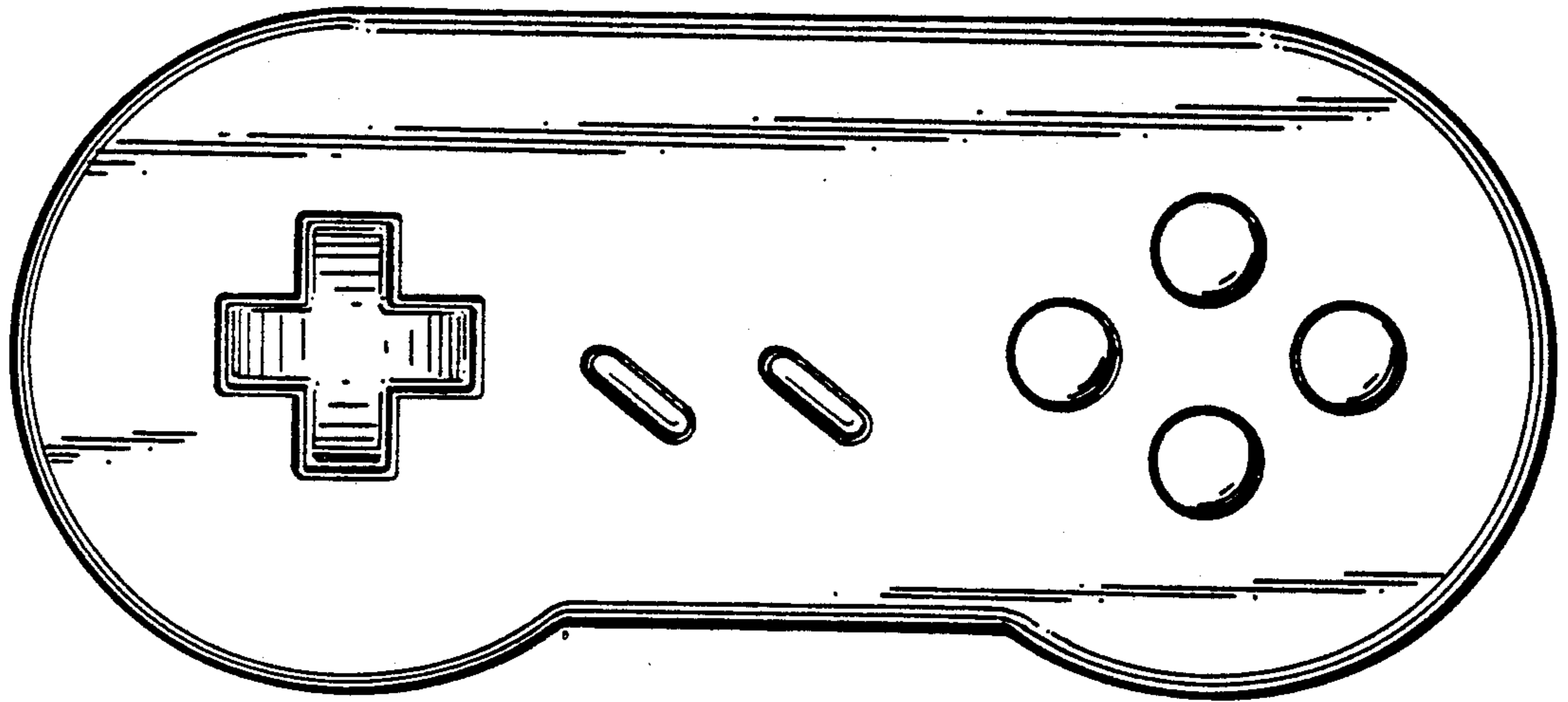

FIG. 42

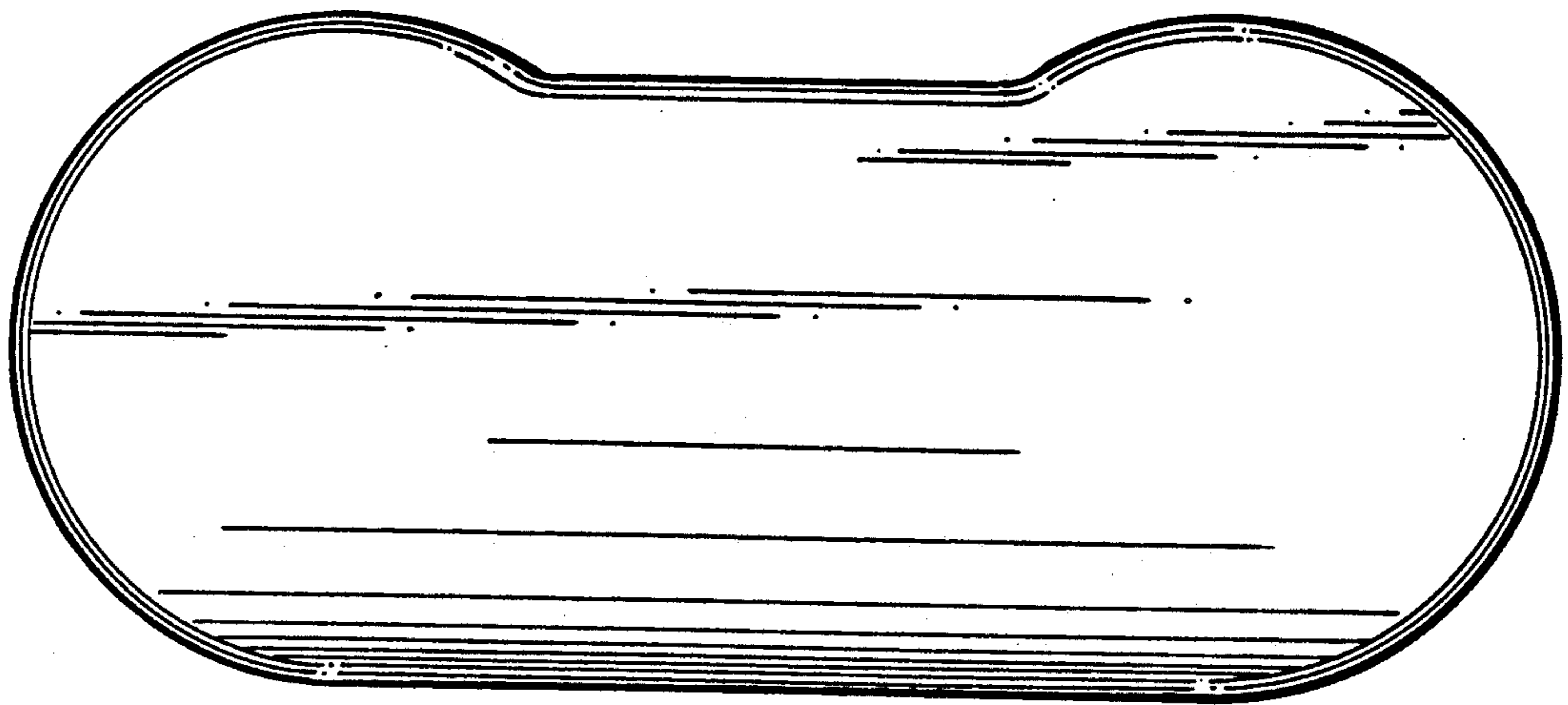

FIG. 43

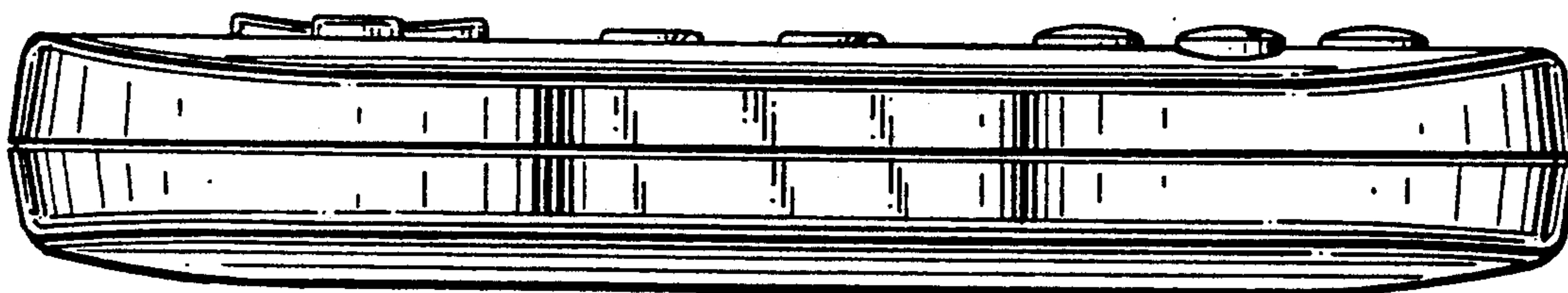

FIG. 44

