



US00D325217S

United States Patent [19]

Grieder et al.

[11] Patent Number: **Des. 325,217**

[45] Date of Patent: **** Apr. 7, 1992**

[54] HOUSING FOR A PRINTER SYSTEM

[75] Inventors: **Anthony M. Grieder**, Arvada, Colo.; **Donald Kleinschnitz**; **John Martin**, both of Melbourne, Fla.; **Gregory D. Volan**, Louisville, Colo.

[73] Assignee: **Storage Technology Corporation**, Louisville, Colo.

[**] Term: **14 Years**

[21] Appl. No.: **420,237**

[22] Filed: **Oct. 12, 1989**

[52] U.S. Cl. **D18/53; D18/39**

[58] Field of Search **D18/13, 36-39; D14/106, 111; 400/613, 613.1-613.4, 691-694; 101/9, 130, 420**

[56] References Cited

U.S. PATENT DOCUMENTS

D. 245,911	9/1977	Bevilacqua et al.	D18/38
D. 289,904	5/1987	Hofland	D18/13
D. 291,094	7/1987	Nakade	D18/13
D. 291,313	8/1987	Clark et al.	D14/111
D. 293,686	1/1988	Sutou et al.	D18/13

OTHER PUBLICATIONS

The Xerox 3700 Laser Printing System brochure; 4/85. The Xerox 5700 Electronic Printing System brochure; 2/81; cover photo.

Primary Examiner—A. Hugo Word
Assistant Examiner—CathyAnne MacCormac
Attorney, Agent, or Firm—Dorr, Carson, Sloan & Peterson

[57] CLAIM

The ornamental design for a housing for a printer system, as shown and described.

DESCRIPTION

FIG. 1 is a perspective view of a housing for a printer system showing our new design; FIG. 2 is a front elevational view thereof; FIG. 3 is a rear elevational view thereof; FIG. 4 is a top plan view thereof; FIG. 5 is a bottom plan view thereof; FIG. 6 is a right side elevational view thereof; and, FIG. 7 is a left side elevational view thereof; The broken lines in FIG. 1 are for illustrative purposes only and form no part of the claimed design.

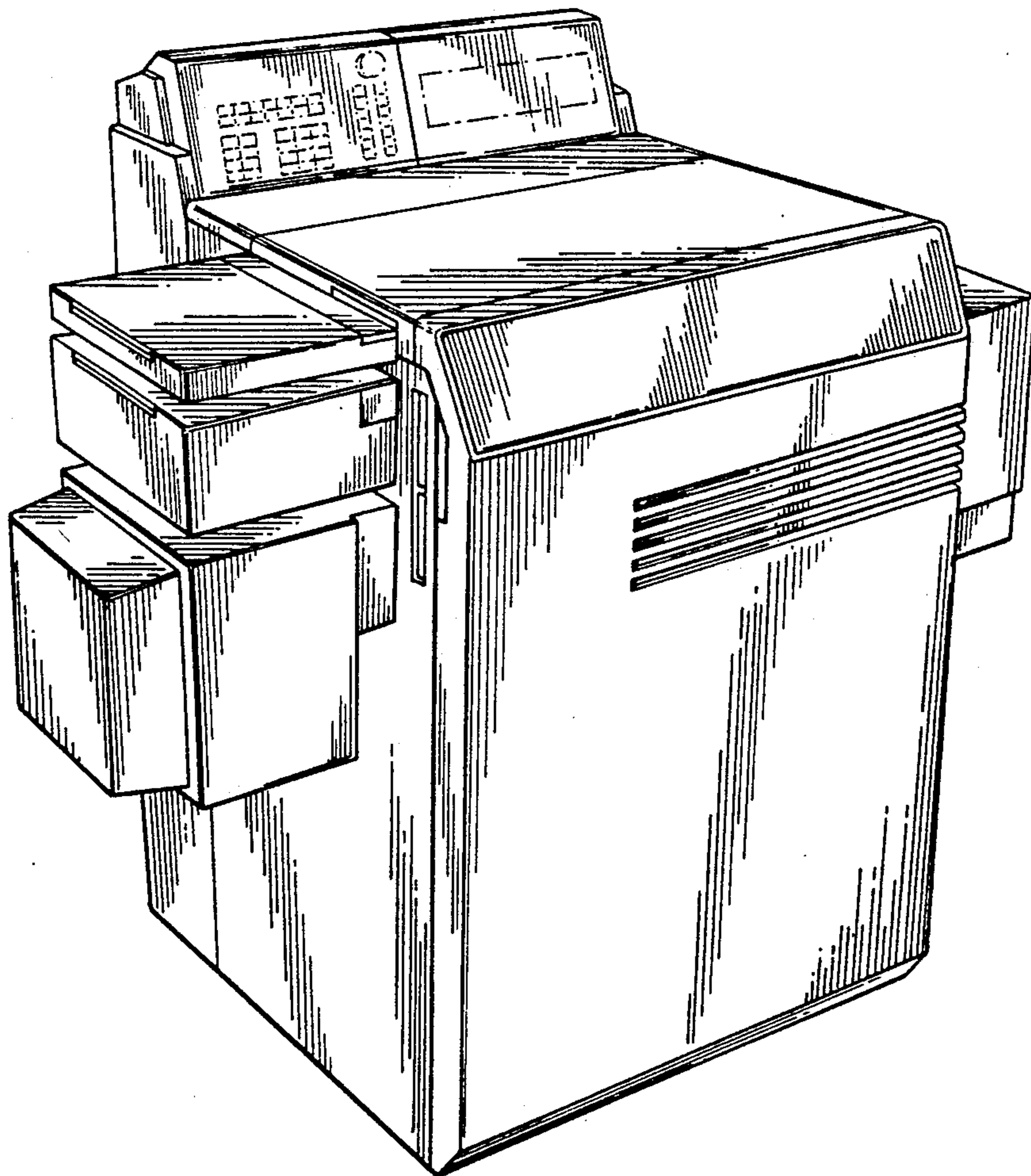

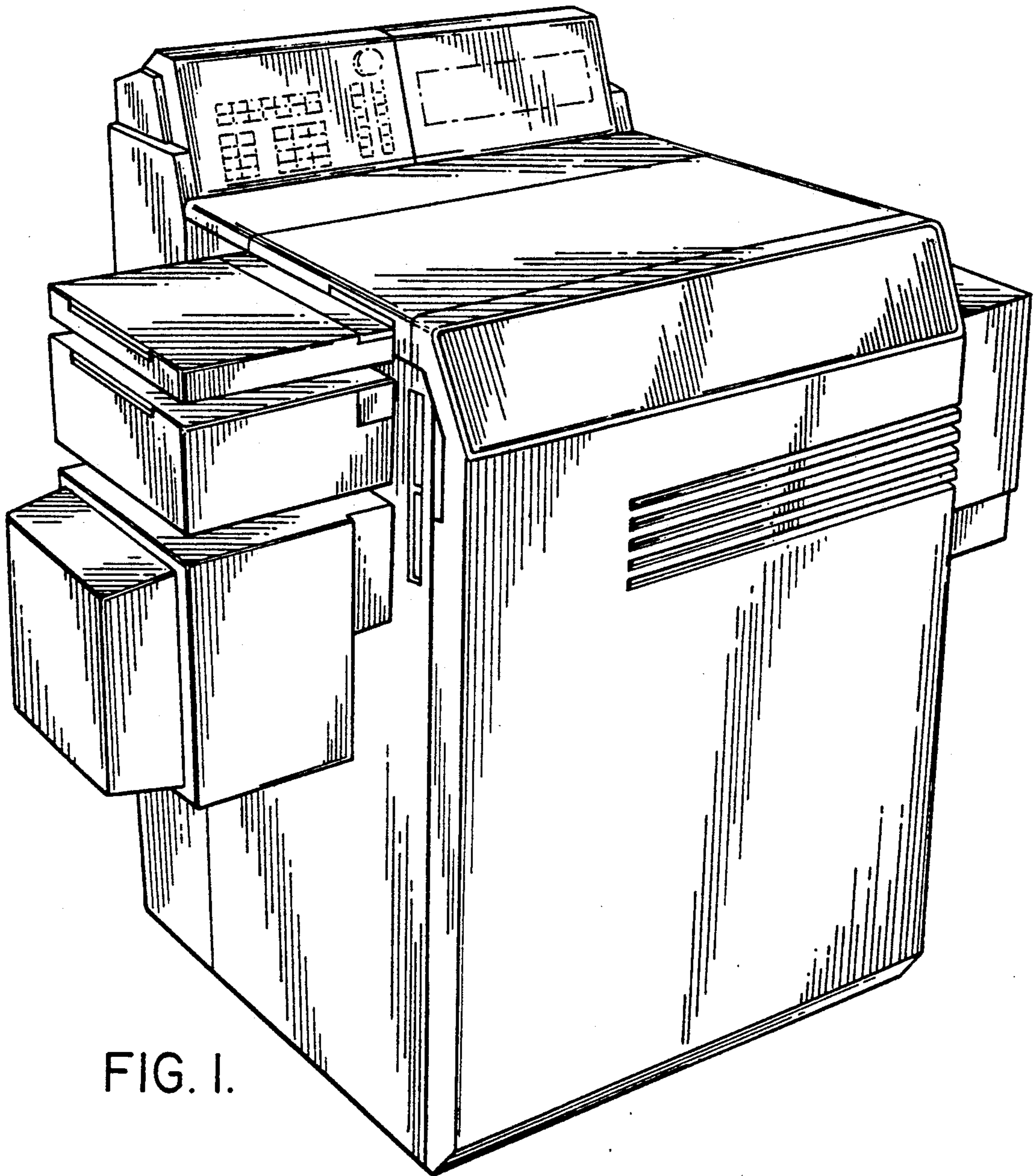

FIG. 1.

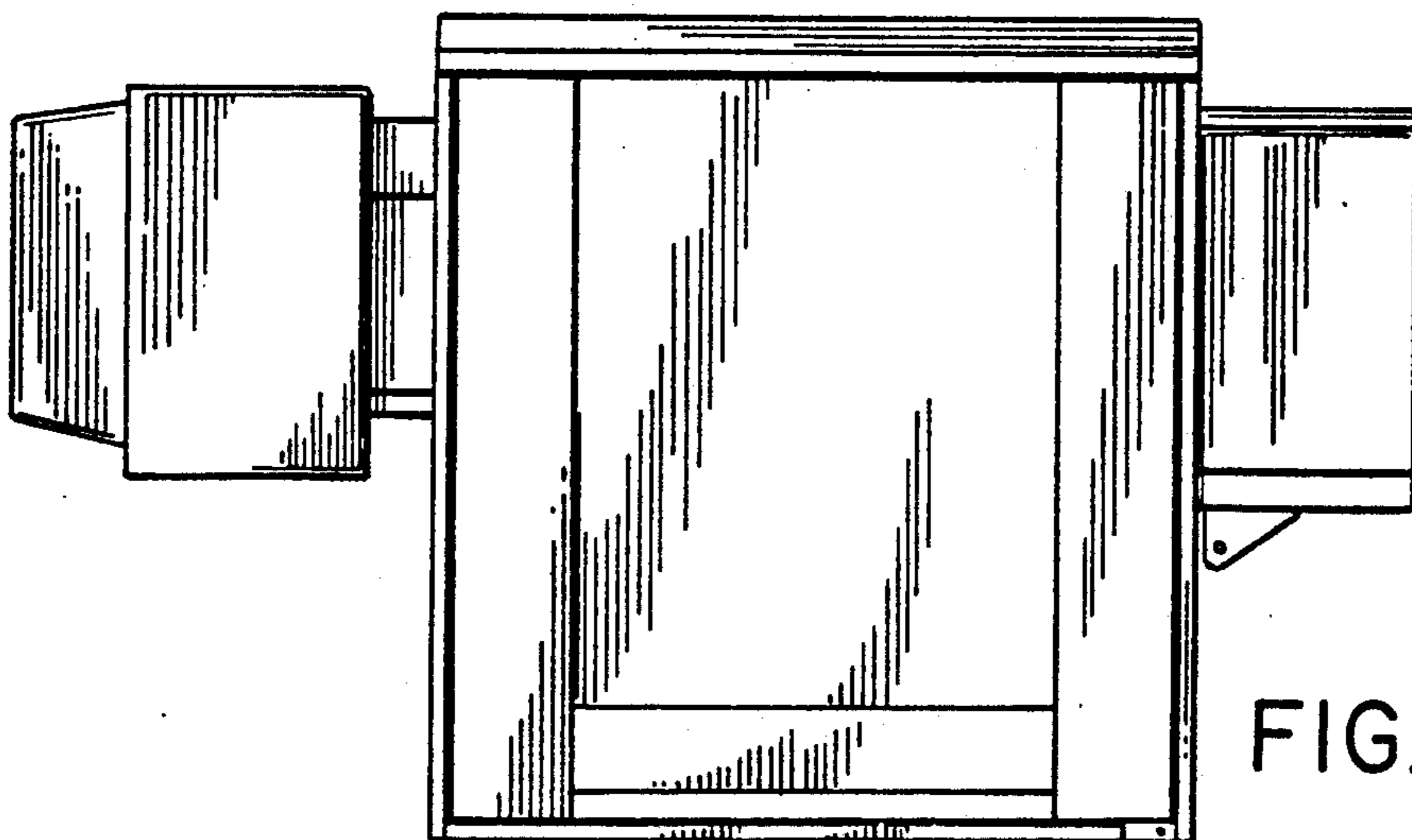

FIG. 5.

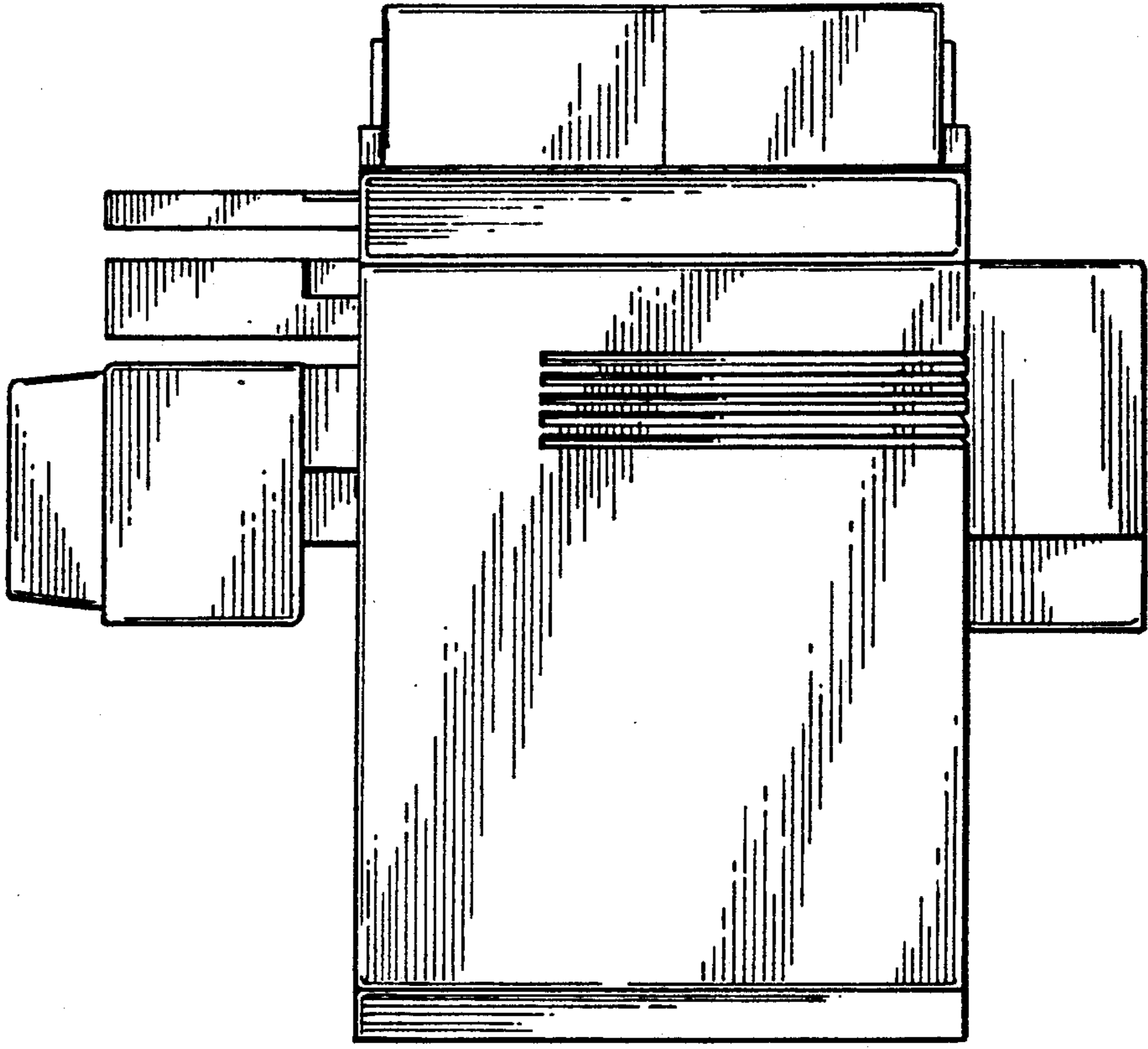

FIG. 2.

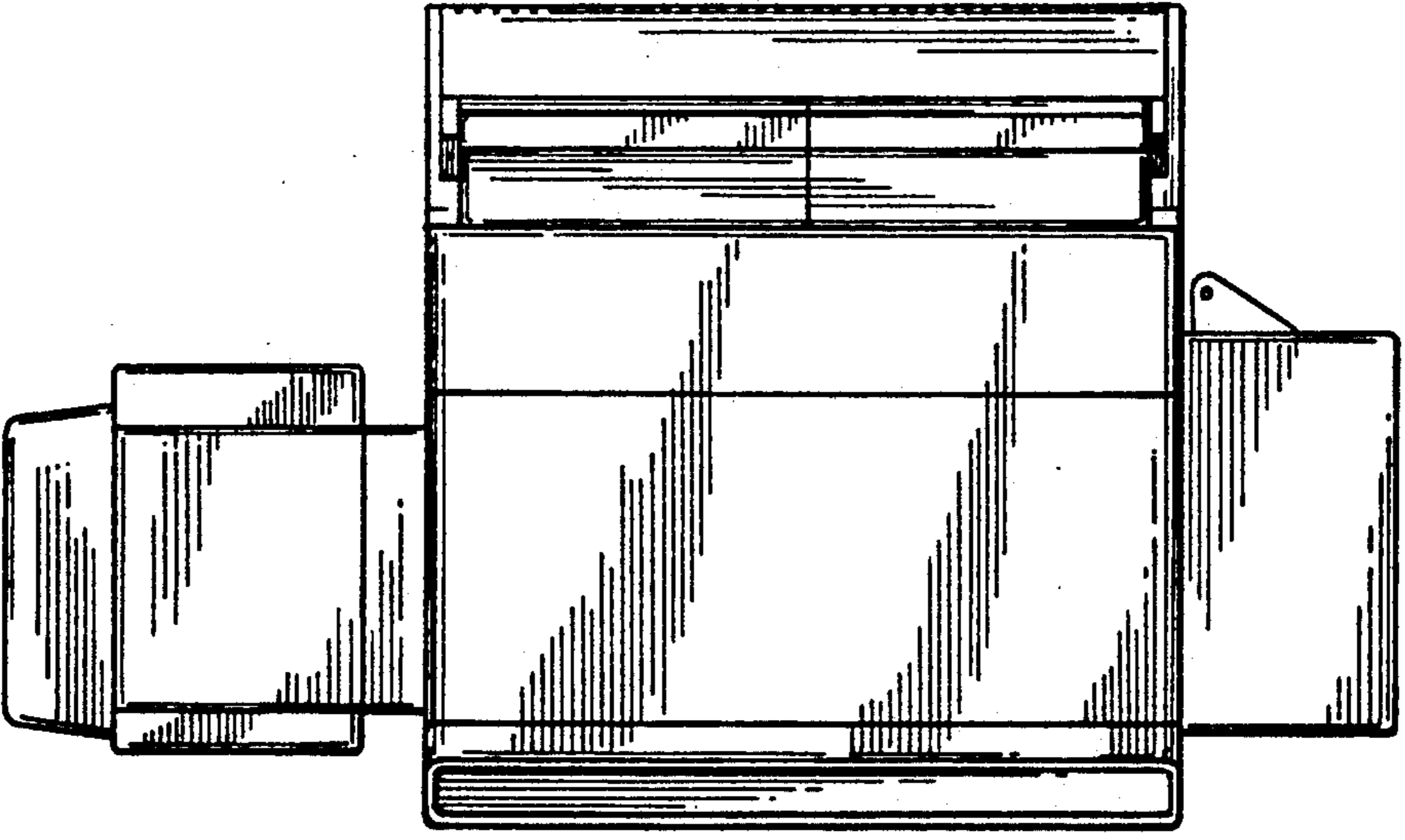

FIG. 4.

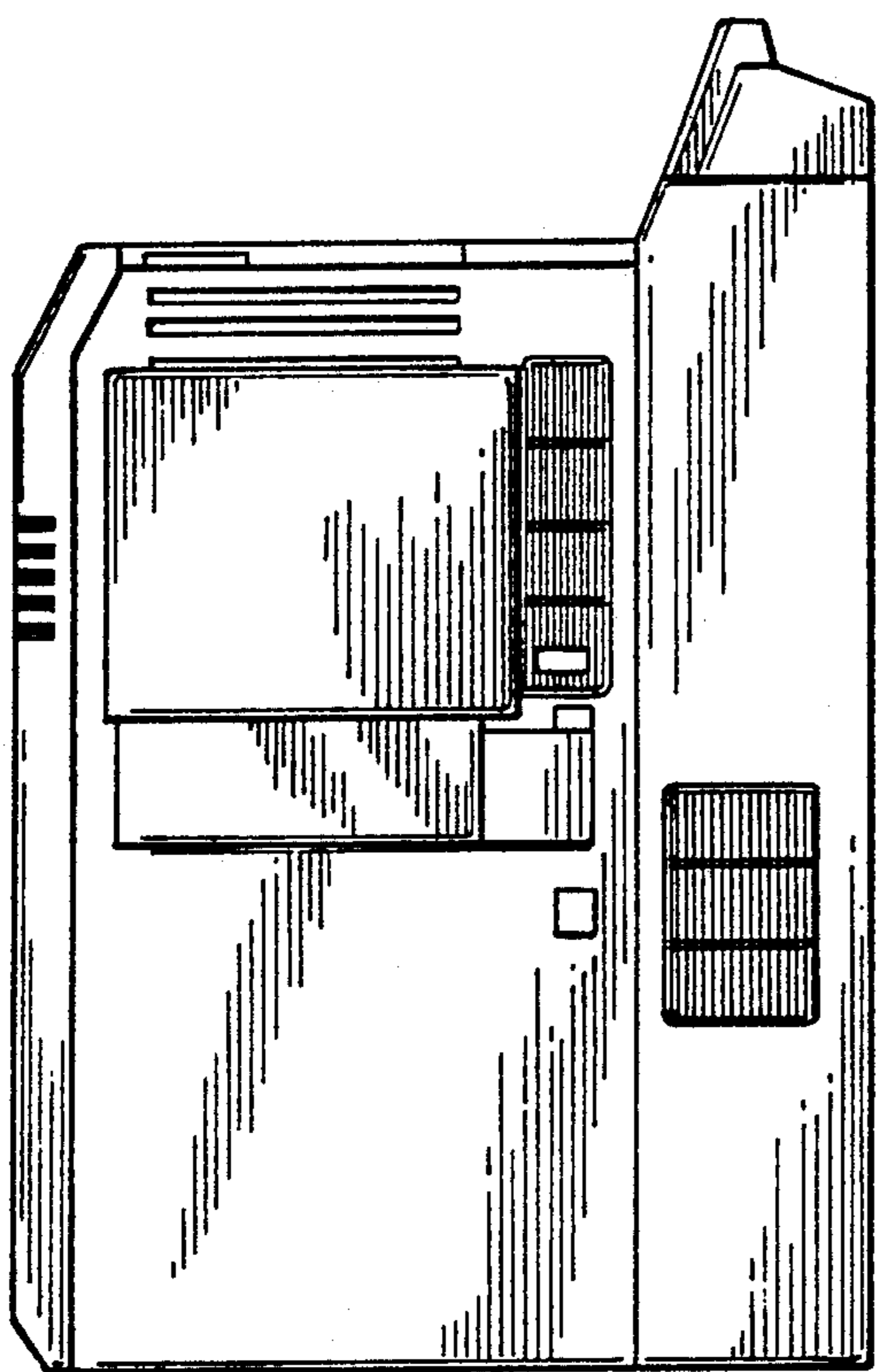

FIG. 6.

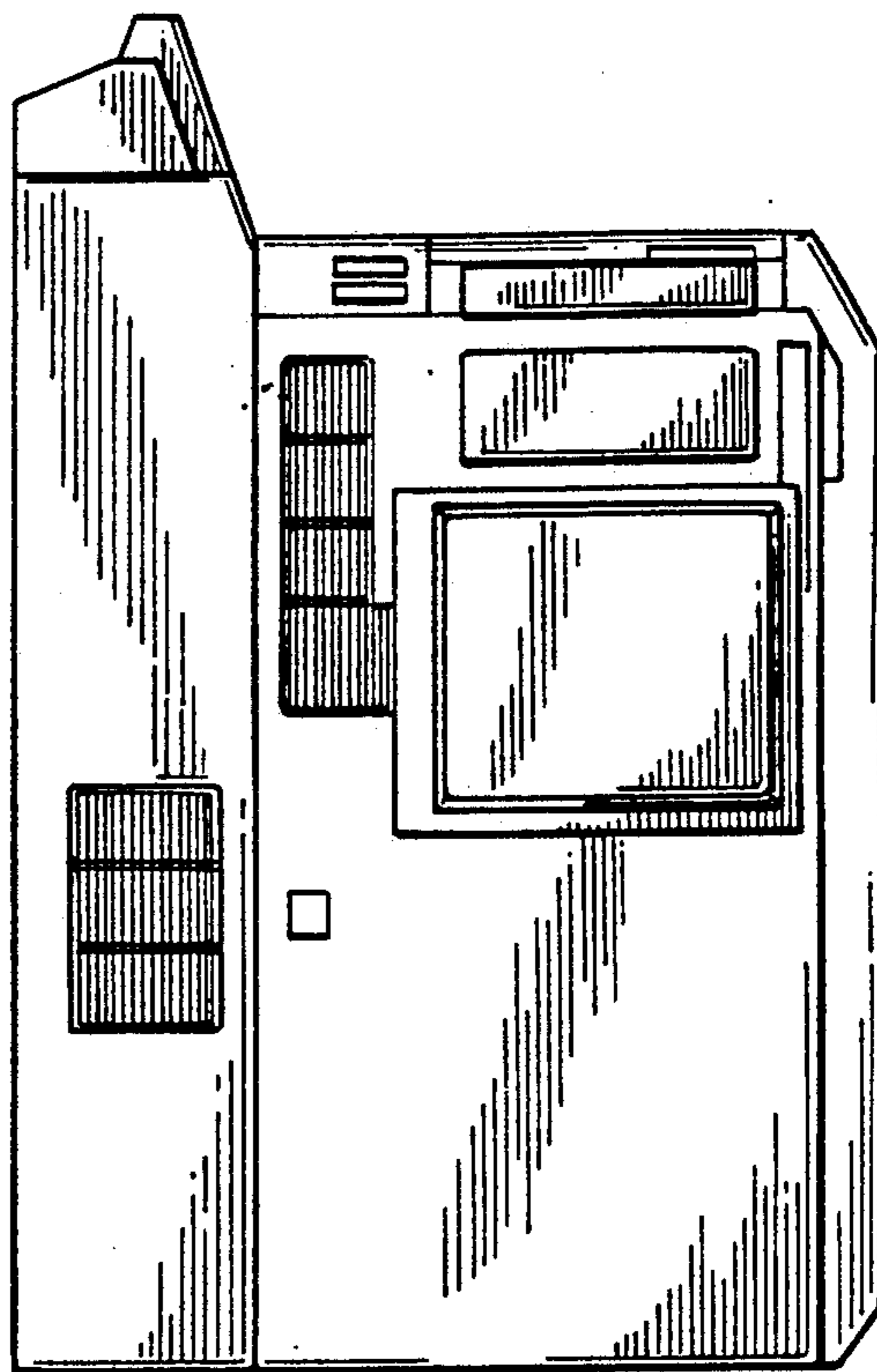

FIG. 7.

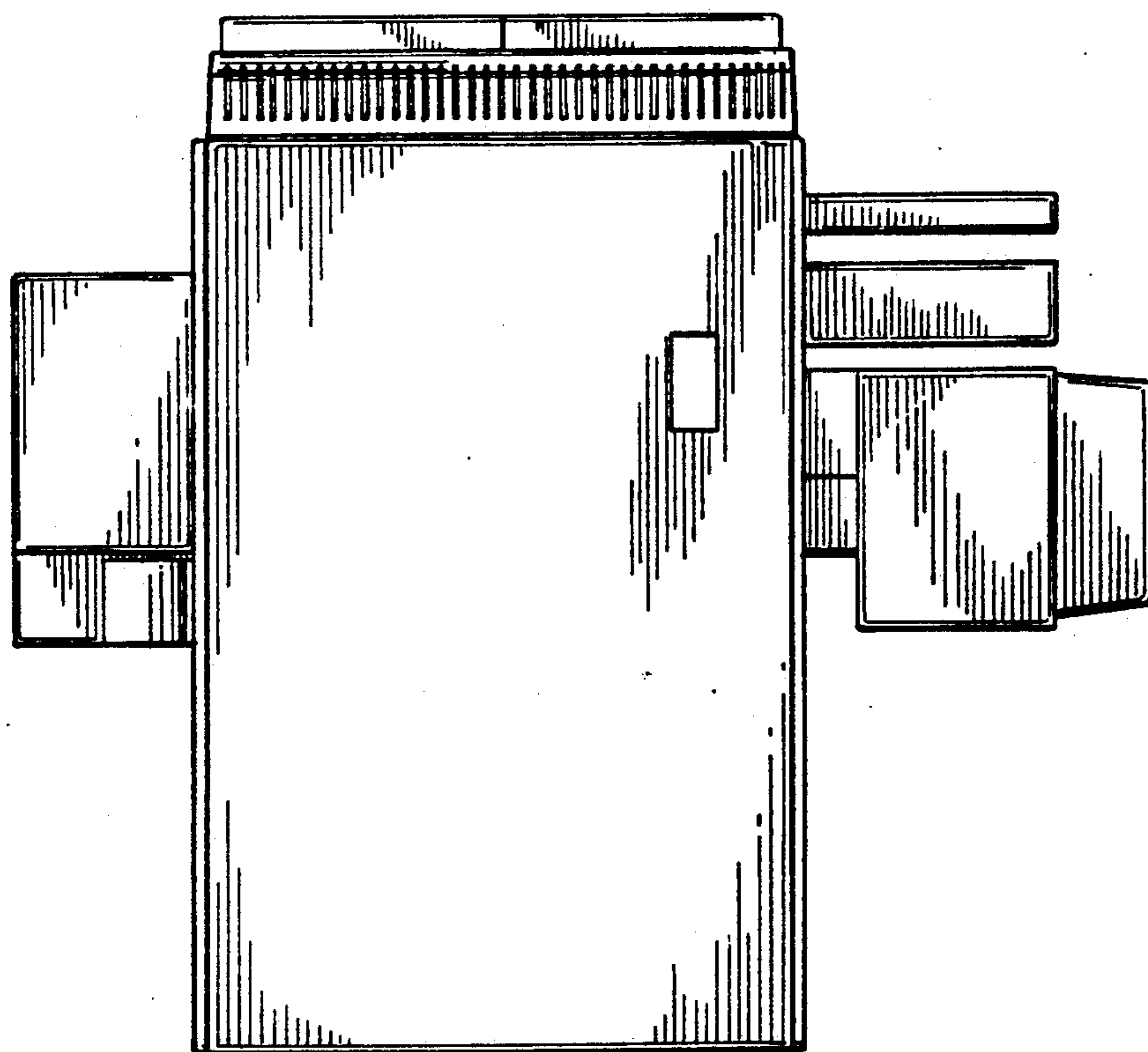

FIG. 3.