



US00D325201S

# United States Patent [19]

Nakatsuka

[11] Patent Number: Des. 325,201

[45] Date of Patent: \*\* Apr. 7, 1992

[54] PORTABLE TELEVISION SET

[75] Inventor: Hiroshi Nakatsuka, Kokubunji, Japan  
[73] Assignee: Casio Computer Co., Ltd., Tokyo, Japan

[\*\*] Term: 14 Years

[21] Appl. No.: 477,207

[22] Filed: Feb. 8, 1990

### Related U.S. Application Data

[62] Division of Ser. No. 231,541, Aug. 11, 1988, Pat. No. Des. 314,958.

### [30] Foreign Application Priority Data

May 6, 1988 [JP] Japan ..... 63-17978  
May 6, 1988 [JP] Japan ..... 63-17979  
May 10, 1988 [JP] Japan ..... 63-18382  
May 10, 1988 [JP] Japan ..... 63-18383  
[52] U.S. Cl. .... D14/126  
[58] Field of Search ..... D14/125-134,  
D14/113, 299; 358/254, 255; 312/7.2

### [56] References Cited

#### U.S. PATENT DOCUMENTS

D. 281,244 11/1985 Ohtsu .  
D. 289,047 3/1987 Suzuki et al. .  
D. 294,699 3/1988 Ohzu .  
D. 294,700 3/1988 Sakuta .  
D. 300,633 4/1989 Makino et al. .  
D. 307,895 5/1990 Kitagawa et al. .... D14/126  
4,639,225 1/1987 Washizuka .

#### OTHER PUBLICATIONS

HFD; Dec. 7, 1987; p. 99; top right—Sharp LCD TV.  
HFD; Jun. 6, 1988; p. 120; Left—Casio color LCD TV.

Primary Examiner—Theodore M. Shooman  
Attorney, Agent, or Firm—Frishauf, Holtz, Goodman & Woodward

### [57] CLAIM

The ornamental design for a portable television set, as shown and described.

### DESCRIPTION

FIG. 1 is a front elevational view of a portable television set showing my new design;  
FIG. 2 is a top plan view thereof;  
FIG. 3 is a right side elevational view thereof;  
FIG. 4 is a left side elevational view thereof;  
FIG. 5 is a bottom plan view thereof;  
FIG. 6 is a rear elevational view thereof; and,  
FIG. 7 is a front and right-side perspective view thereof.

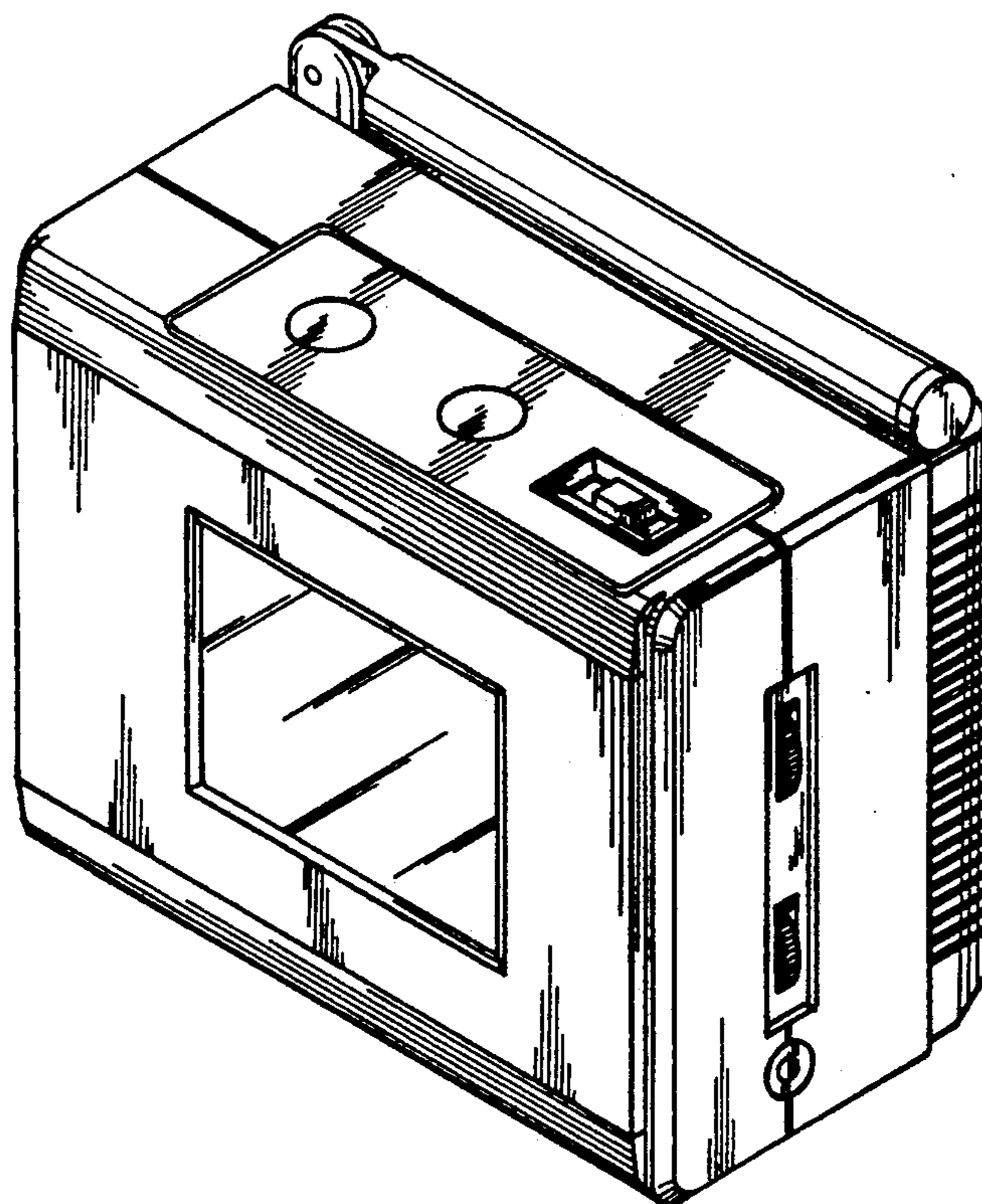

FIG. 2

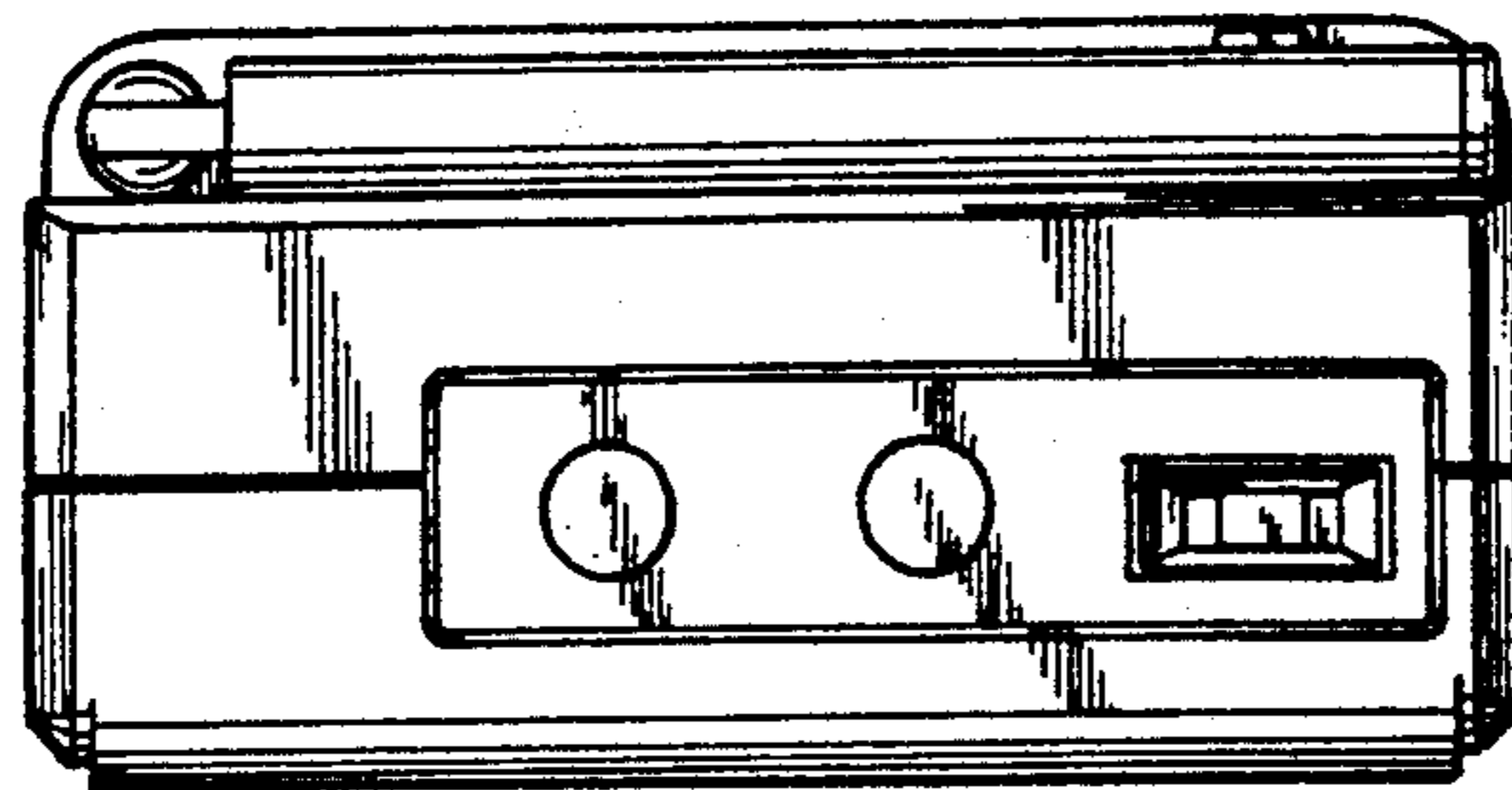

FIG. 4

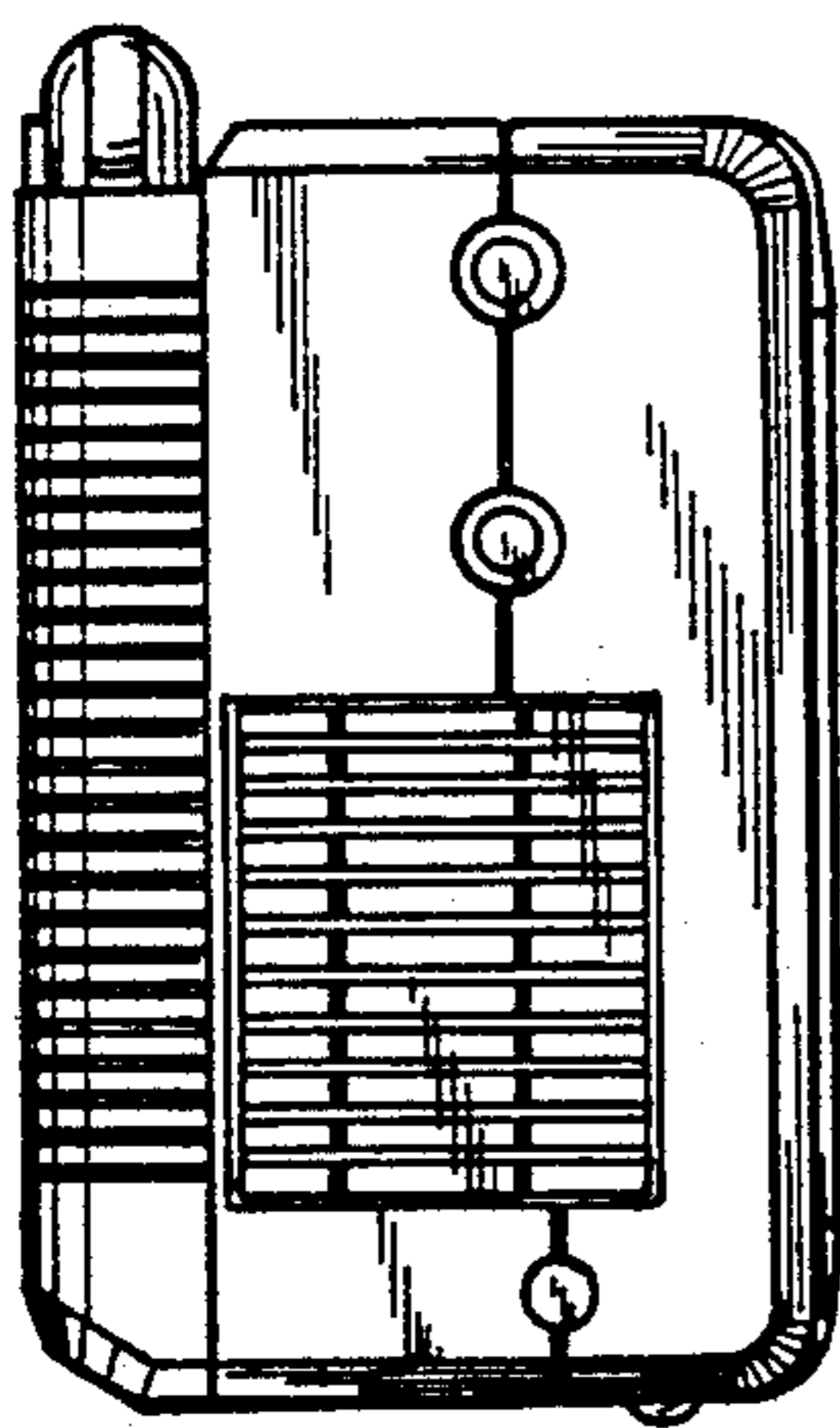

FIG. 1

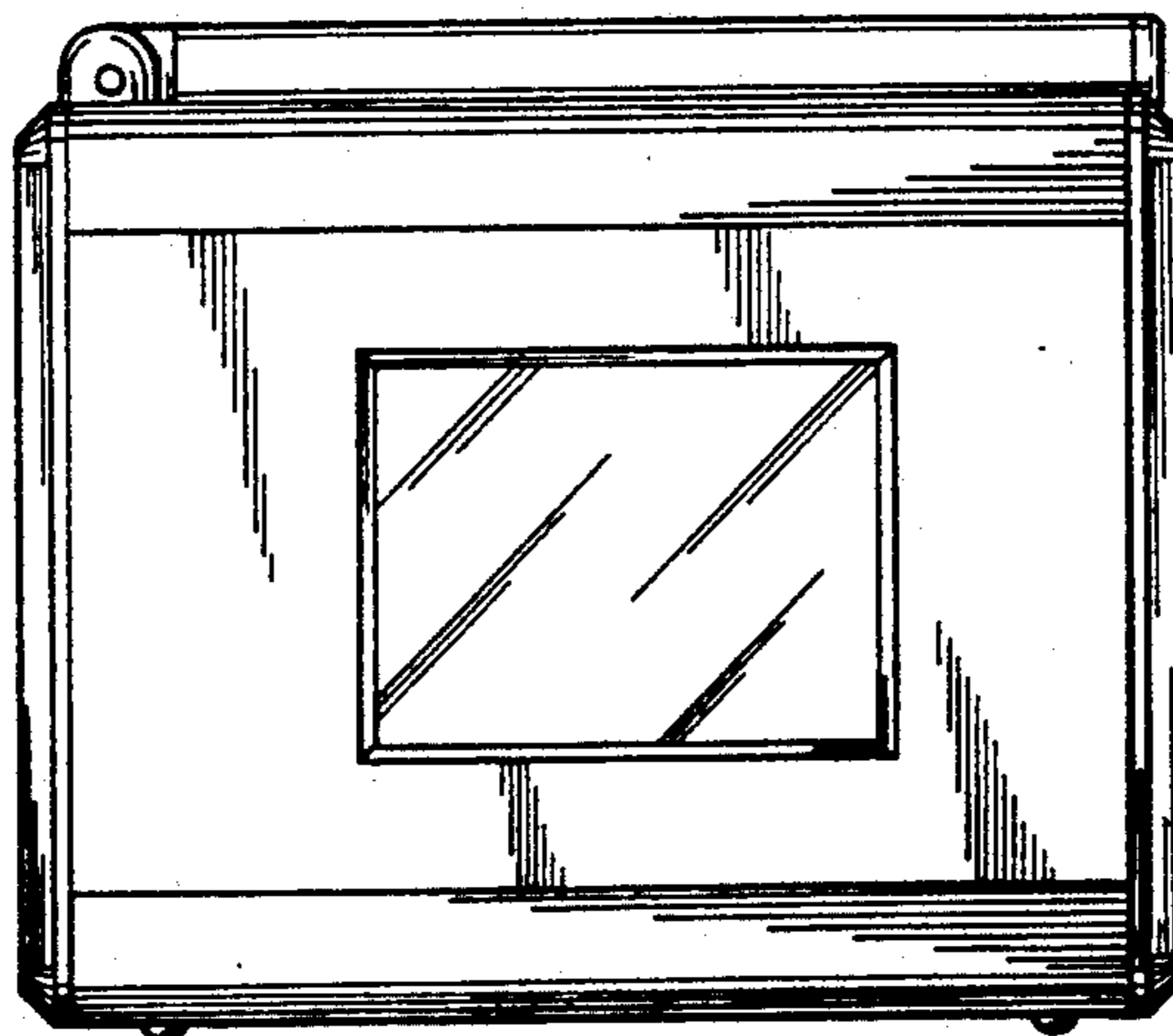

FIG. 3

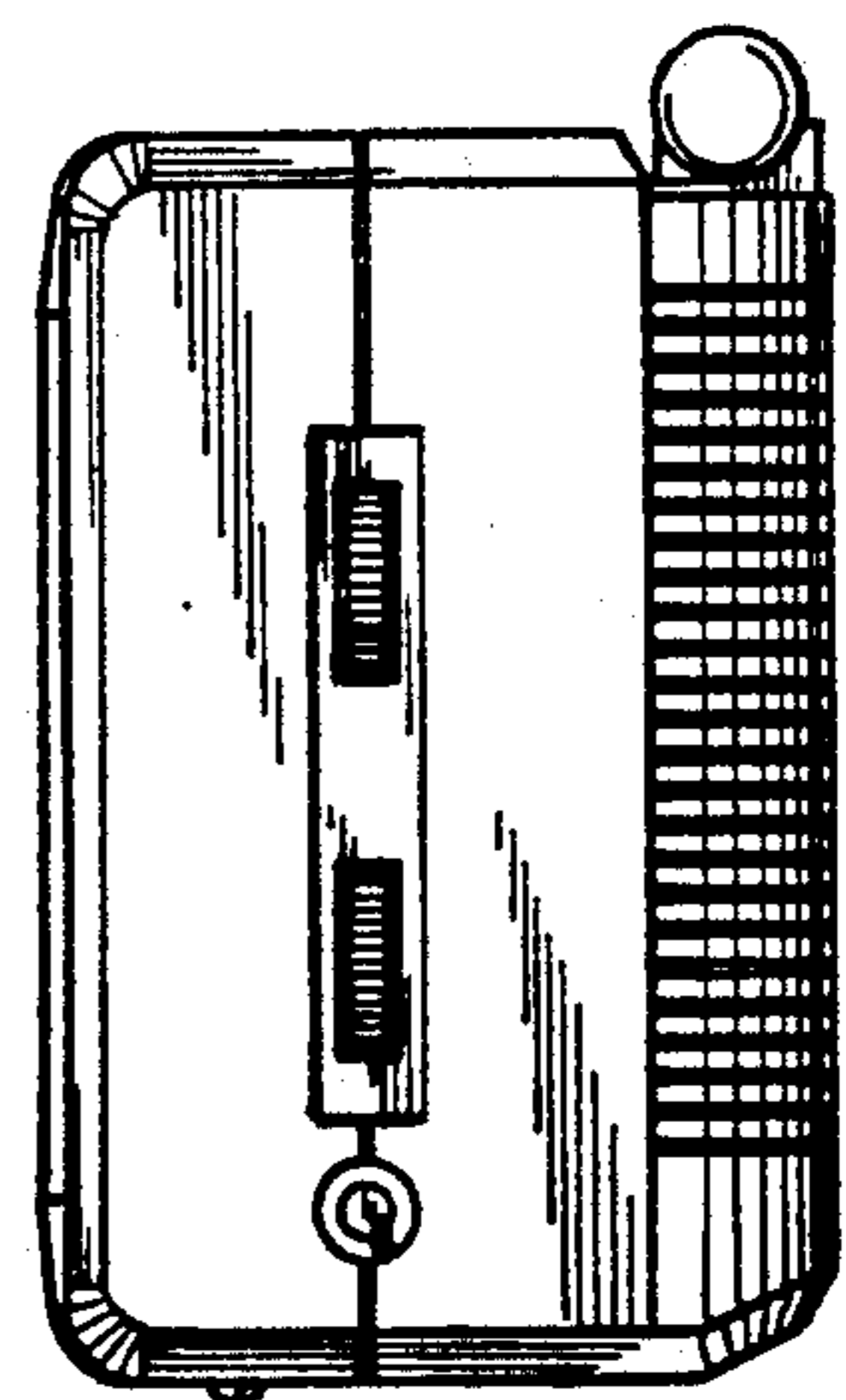

FIG. 5

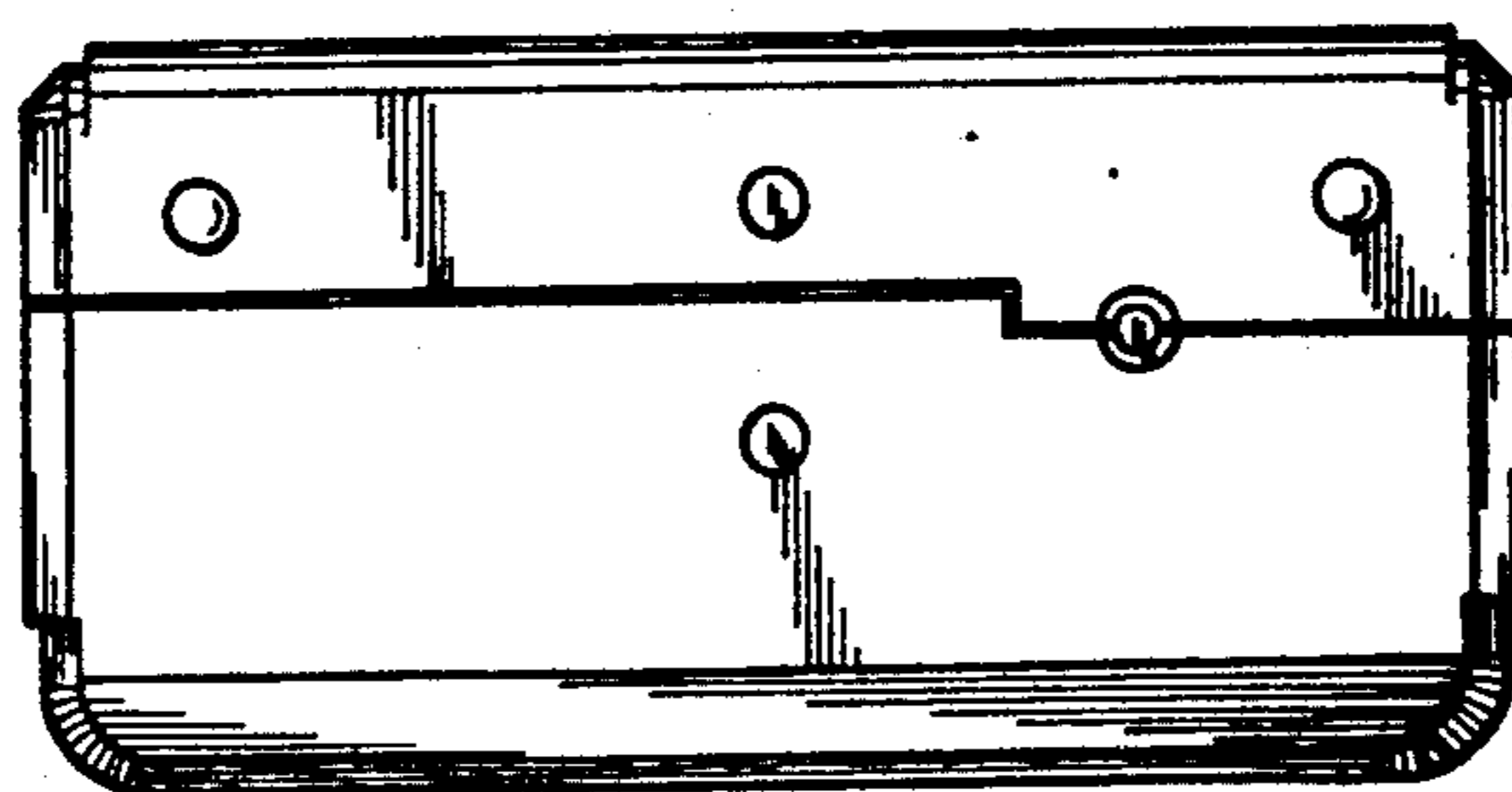

FIG. 6

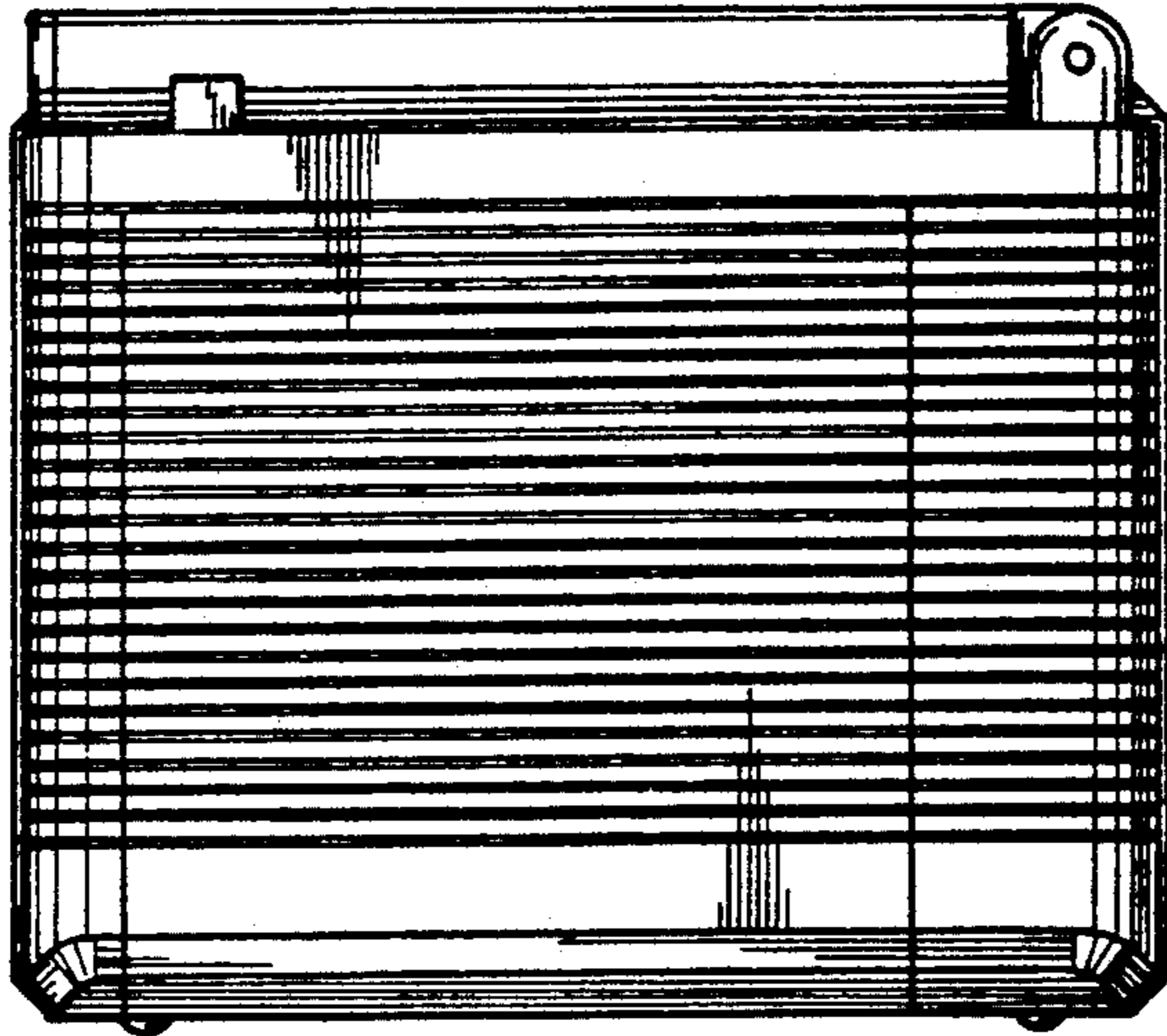

FIG. 7

