



US00D325166S

United States Patent [19]

[11] Patent Number: **Des. 325,166**

Versace

[45] Date of Patent: **** Apr. 7, 1992**

[54] COMBINED PERFUME BOTTLE AND CLOSURE

- [75] Inventor: **Gianni Versace, Milan, Italy**
- [73] Assignee: **Versace Profumi S.p.A., Milan, Italy**
- [**] Term: **14 Years**
- [21] Appl. No.: **424,566**
- [22] Filed: **Oct. 20, 1989**

[30] Foreign Application Priority Data

- Apr. 21, 1989 [IT] Italy 20944/89[U]
- [52] U.S. Cl. **D9/384; D9/367; D9/401**
- [58] Field of Search D9/367, 384, 386, 375, D9/388, 401, 403-413; 215/1 R, 1 C

[56] References Cited

U.S. PATENT DOCUMENTS

- D. 80,363 1/1930 De Wagner D9/375
- D. 81,633 7/1930 De Wagner D9/370
- D. 92,078 4/1934 Guerlain D9/384 X

OTHER PUBLICATIONS

Beauty Fashion, May 1976, p. 69, Verfrance "Monument" bottle, bottom left photo, middle bottle.
 Beauty Fashion, Sep. 1980, p. 91, Livia perfume bottle.
Primary Examiner—Bernard Ansher
Assistant Examiner—Lucy Lieberman
Attorney, Agent, or Firm—Birch, Stewart, Kolasch & Birch

[57] CLAIM

The ornamental design for a combined perfume bottle and closure, as shown.

DESCRIPTION

FIG. 1 is a perspective view of a combined perfume bottle and closure showing my new design;
 FIG. 2 is a perspective view of the combined perfume bottle and closure shown in an exploded condition;
 FIG. 3 is a rear elevation of FIG. 1;
 FIG. 4 is a right side elevation of FIG. 1;
 FIG. 5 is a front elevation of FIG. 1;
 FIG. 6 is a left side elevation of FIG. 1;
 FIG. 7 is a top plan view of FIG. 1; and,
 FIG. 8 is a bottom plan view of FIG. 1.

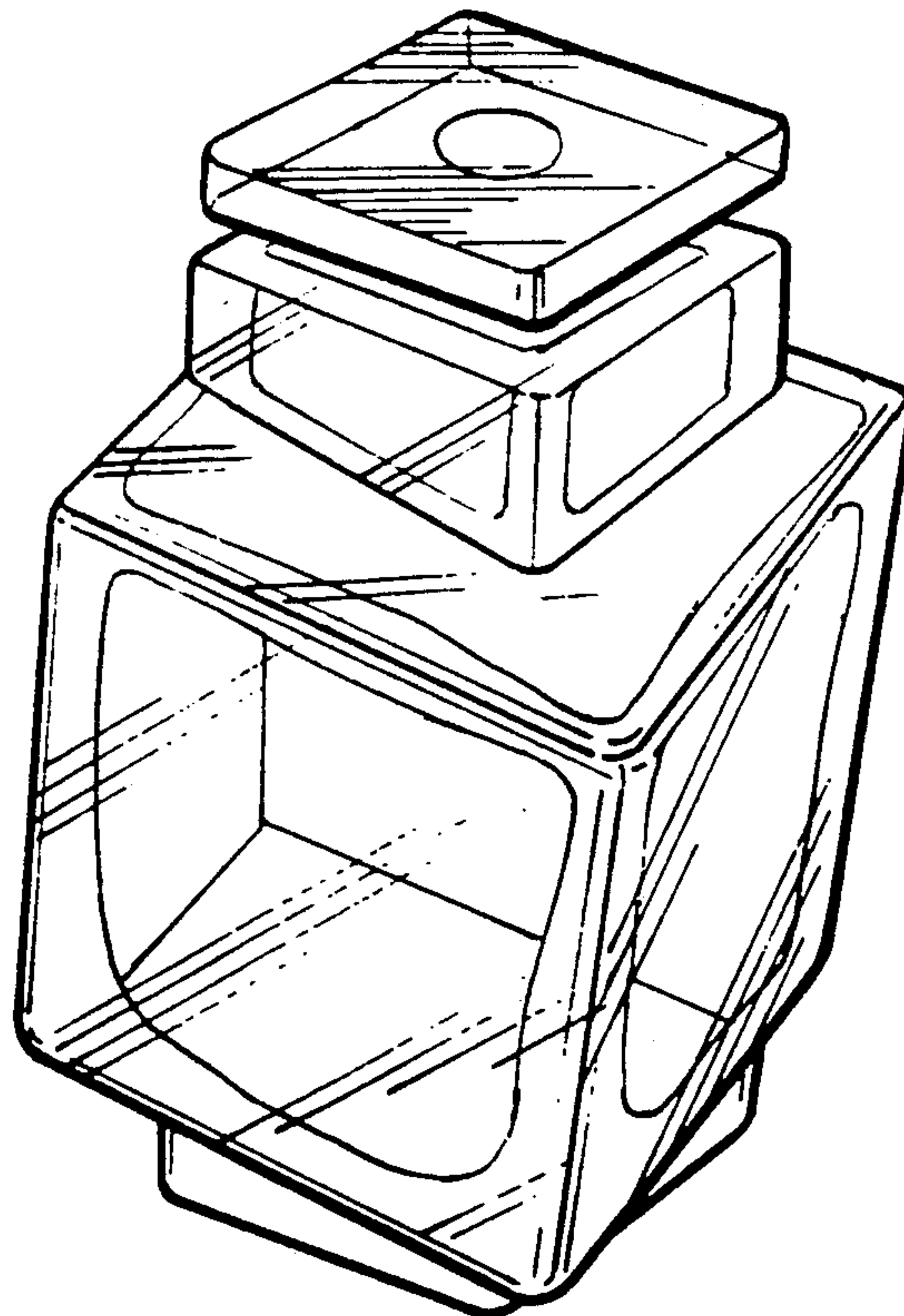

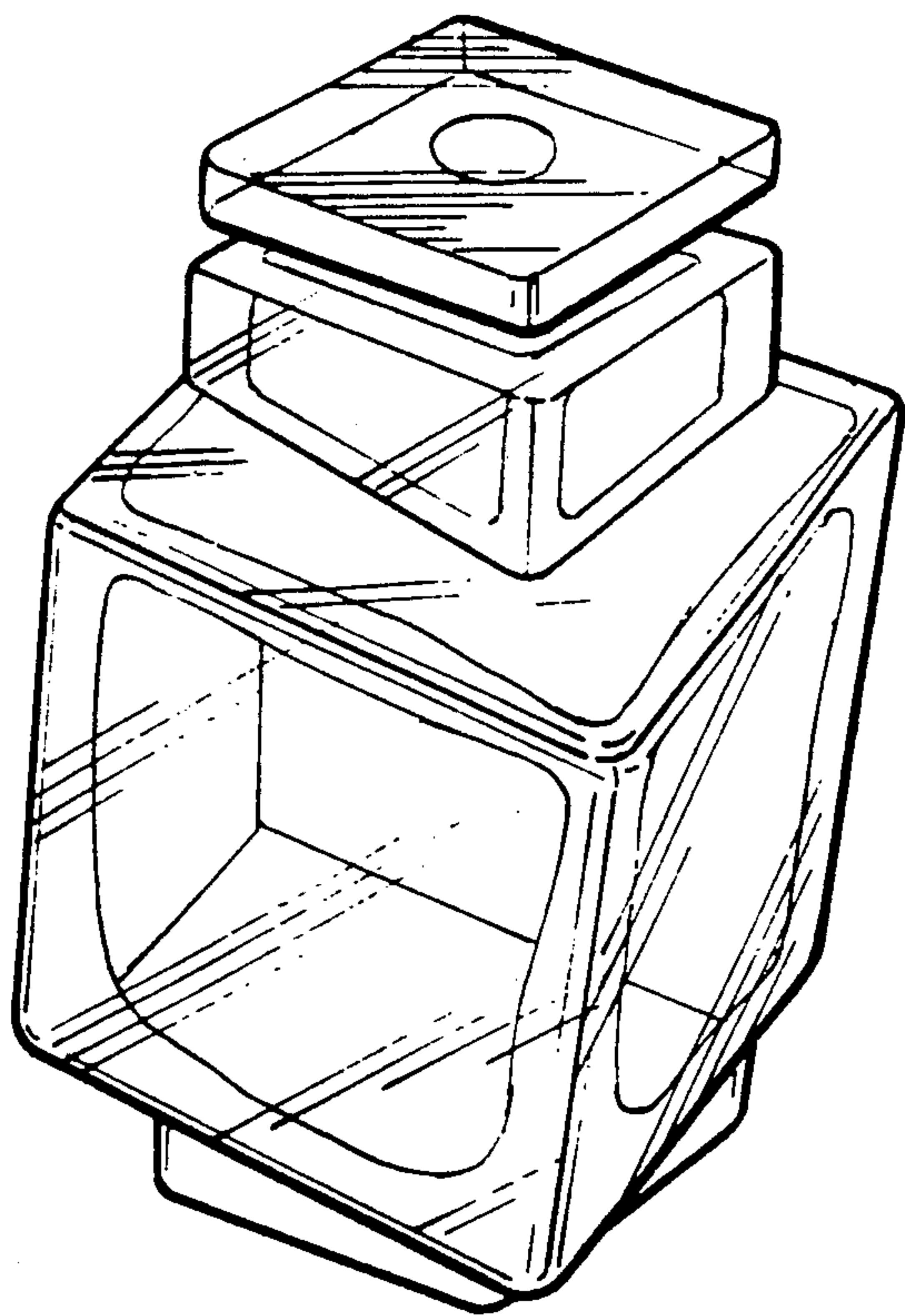

FIG. 1

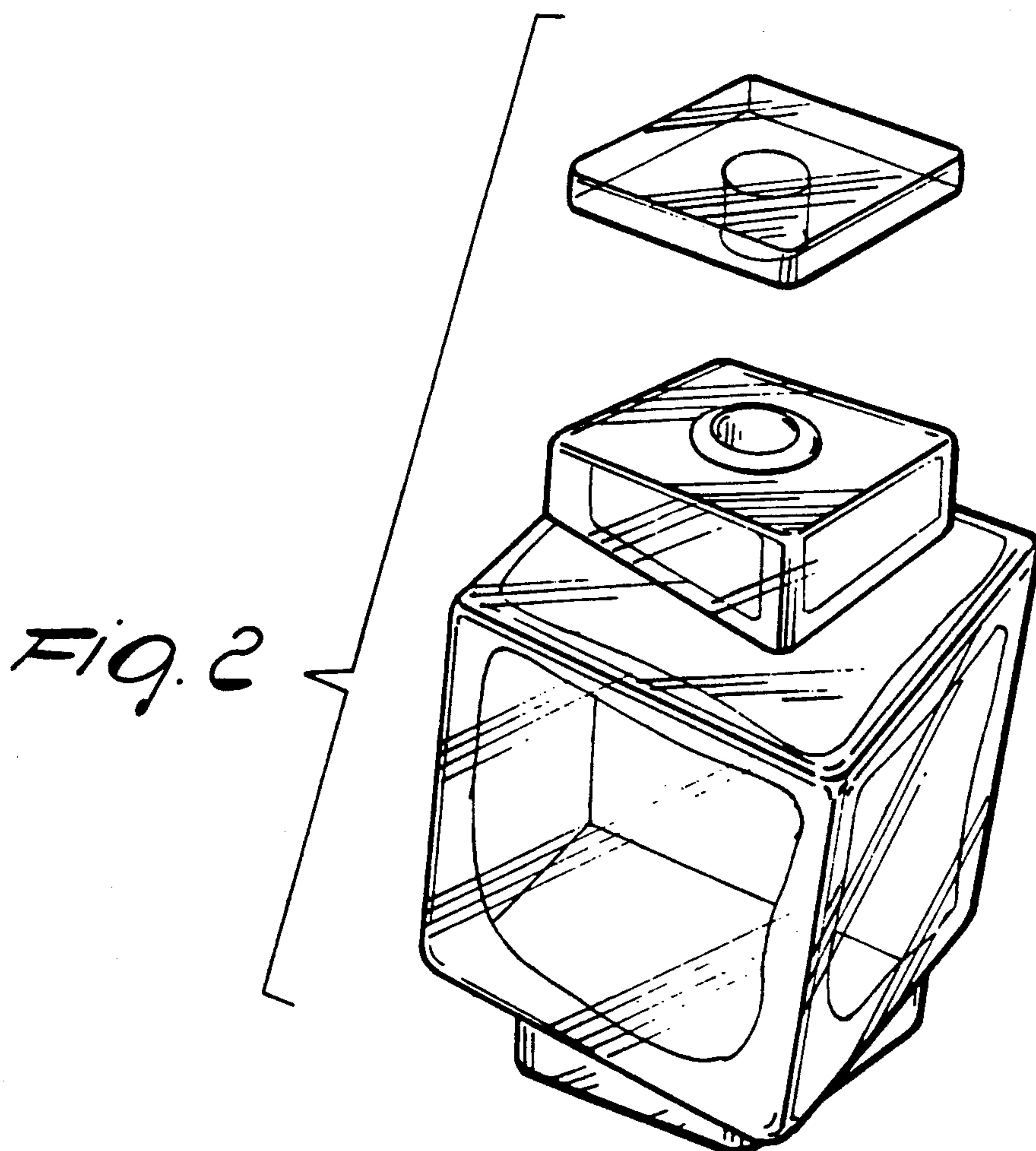

FIG. 2

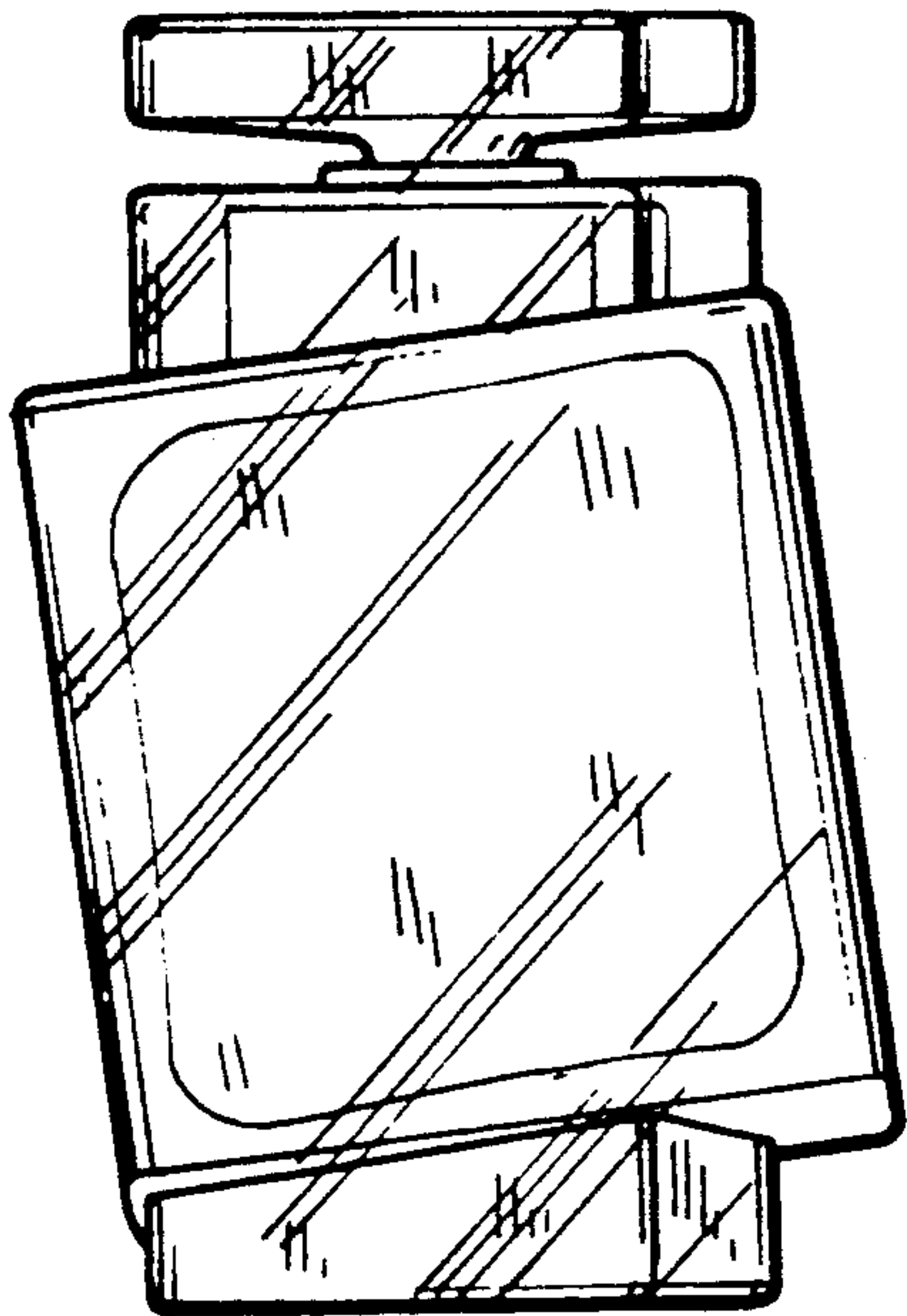

FIG. 3

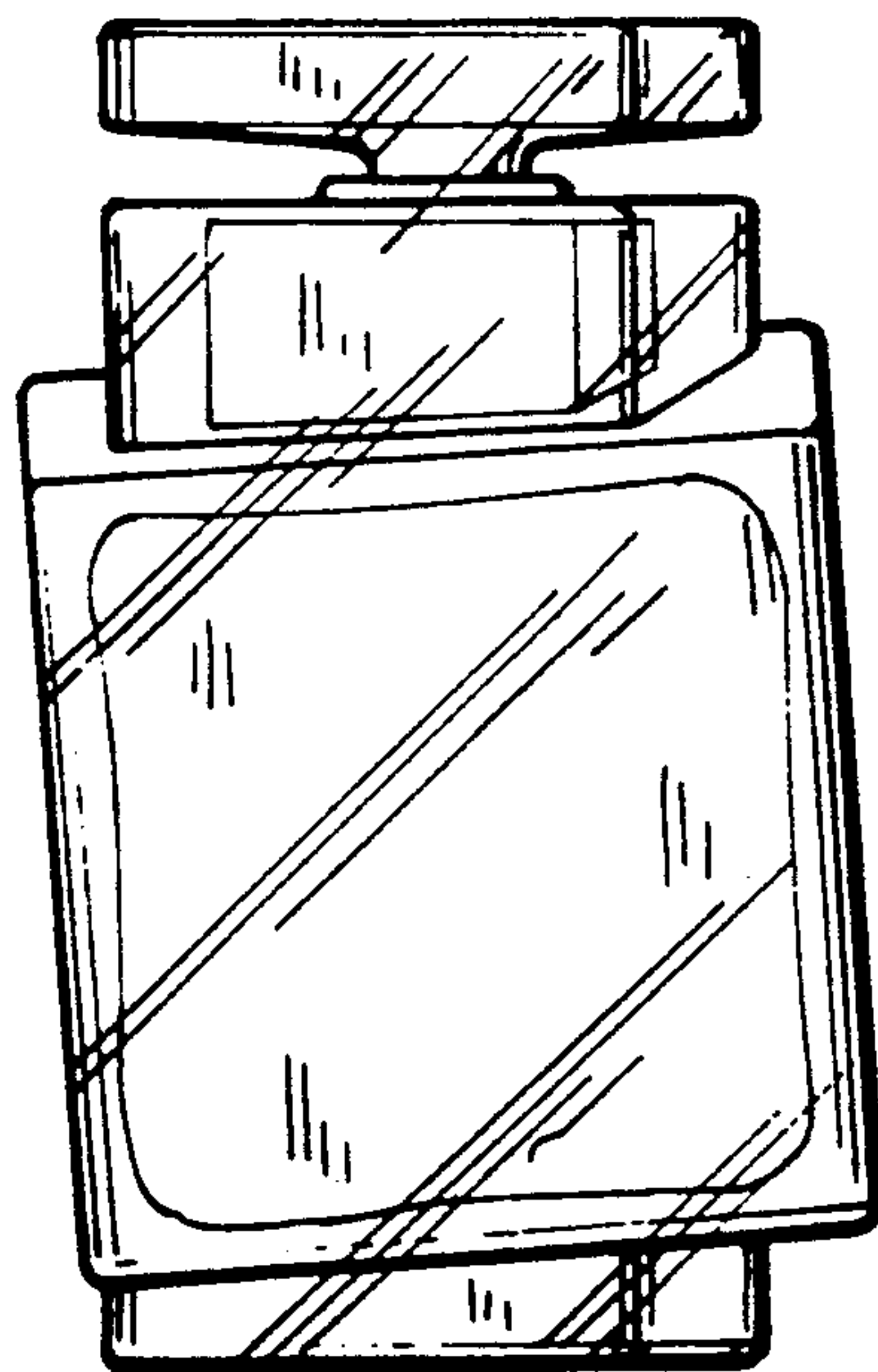

FIG. 4

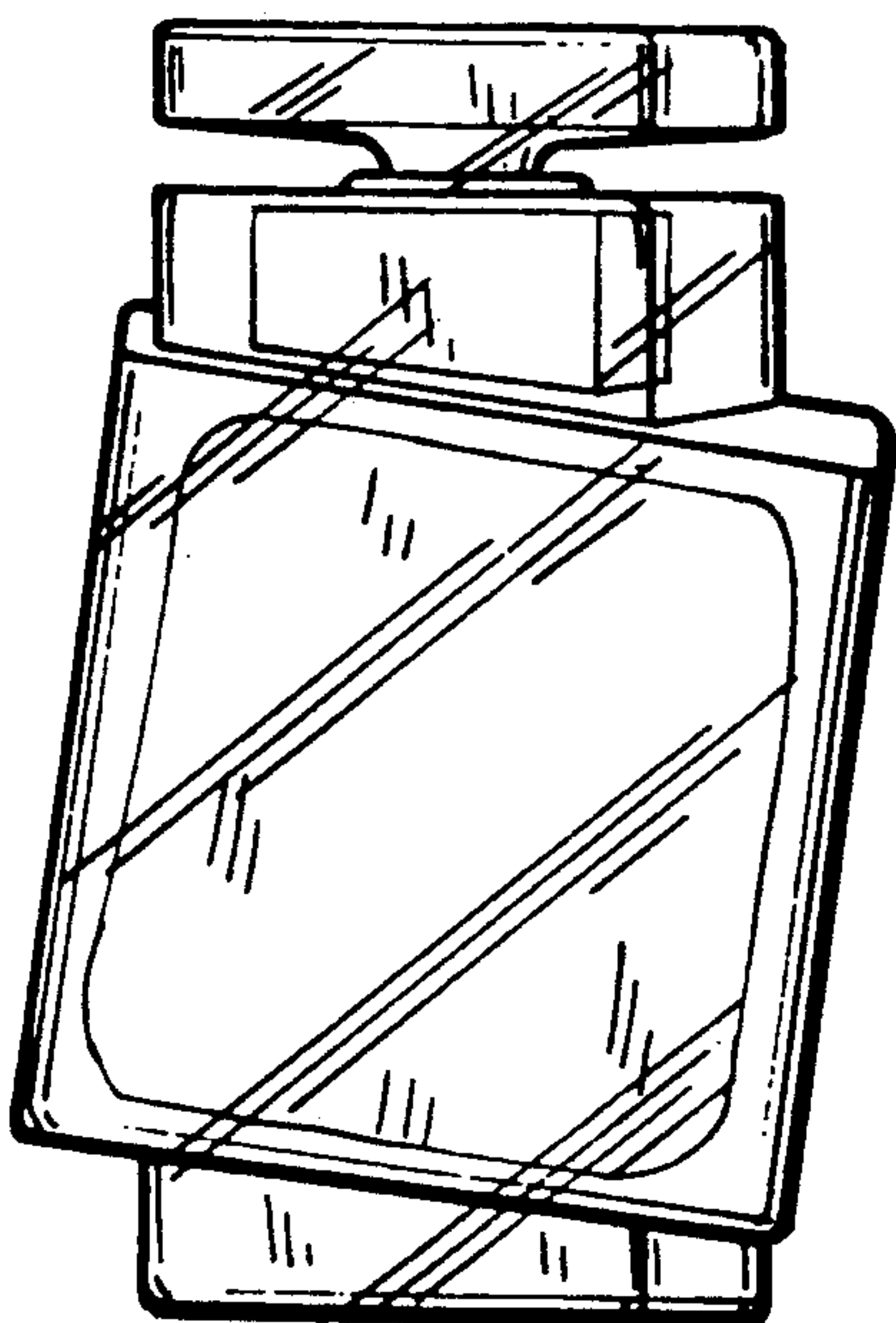

FIG. 5

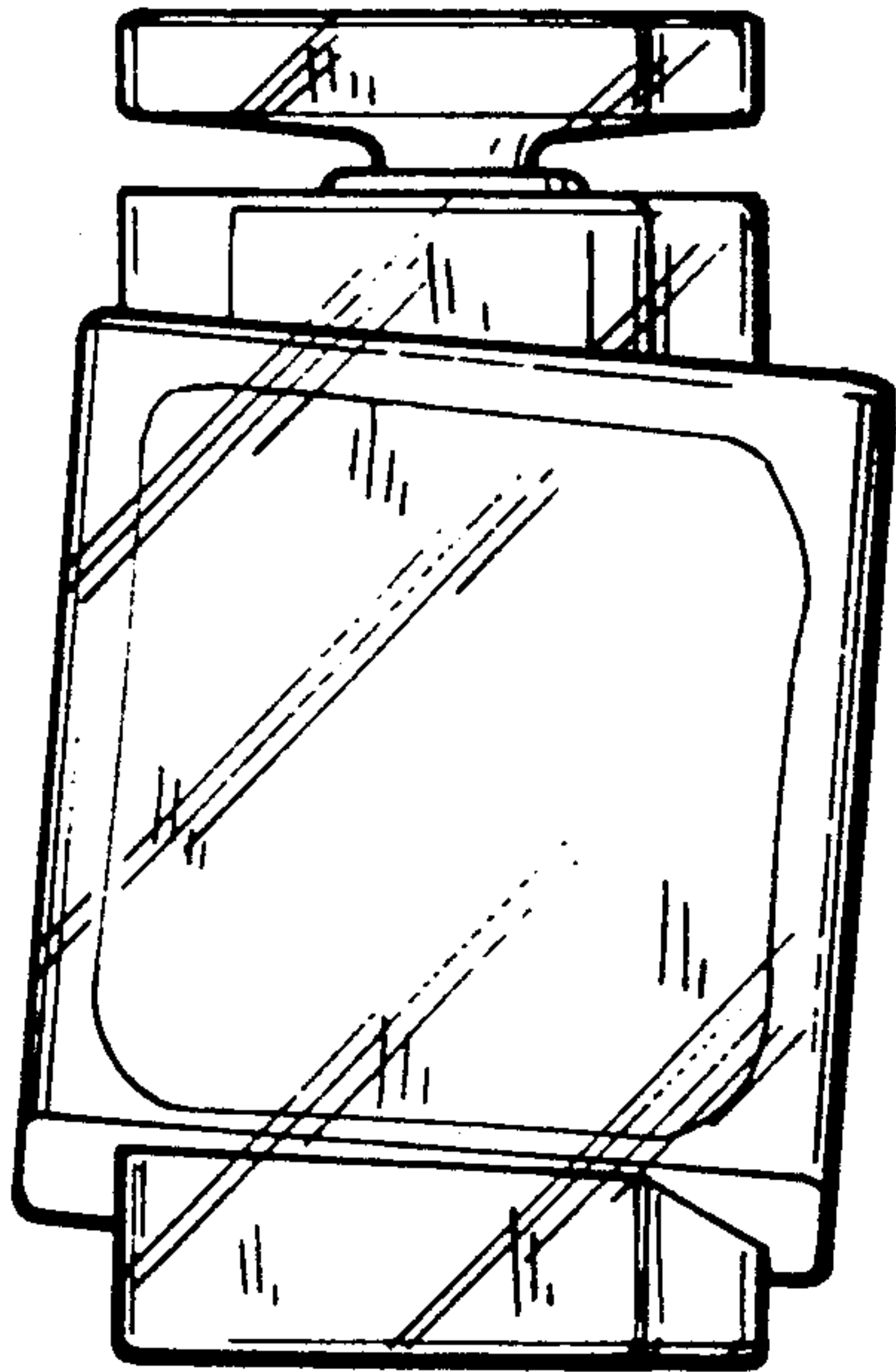

FIG. 6

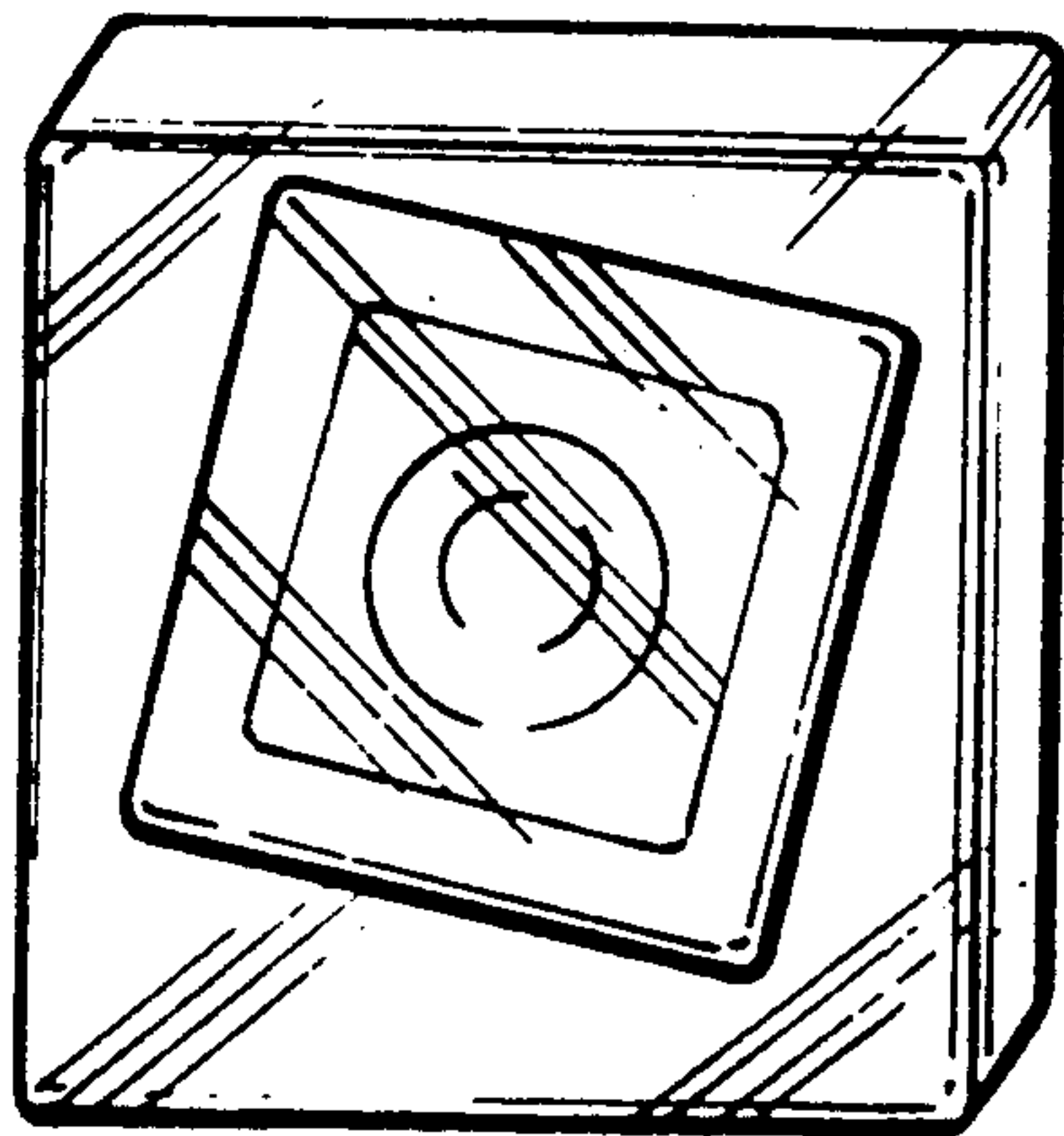

FIG. 7

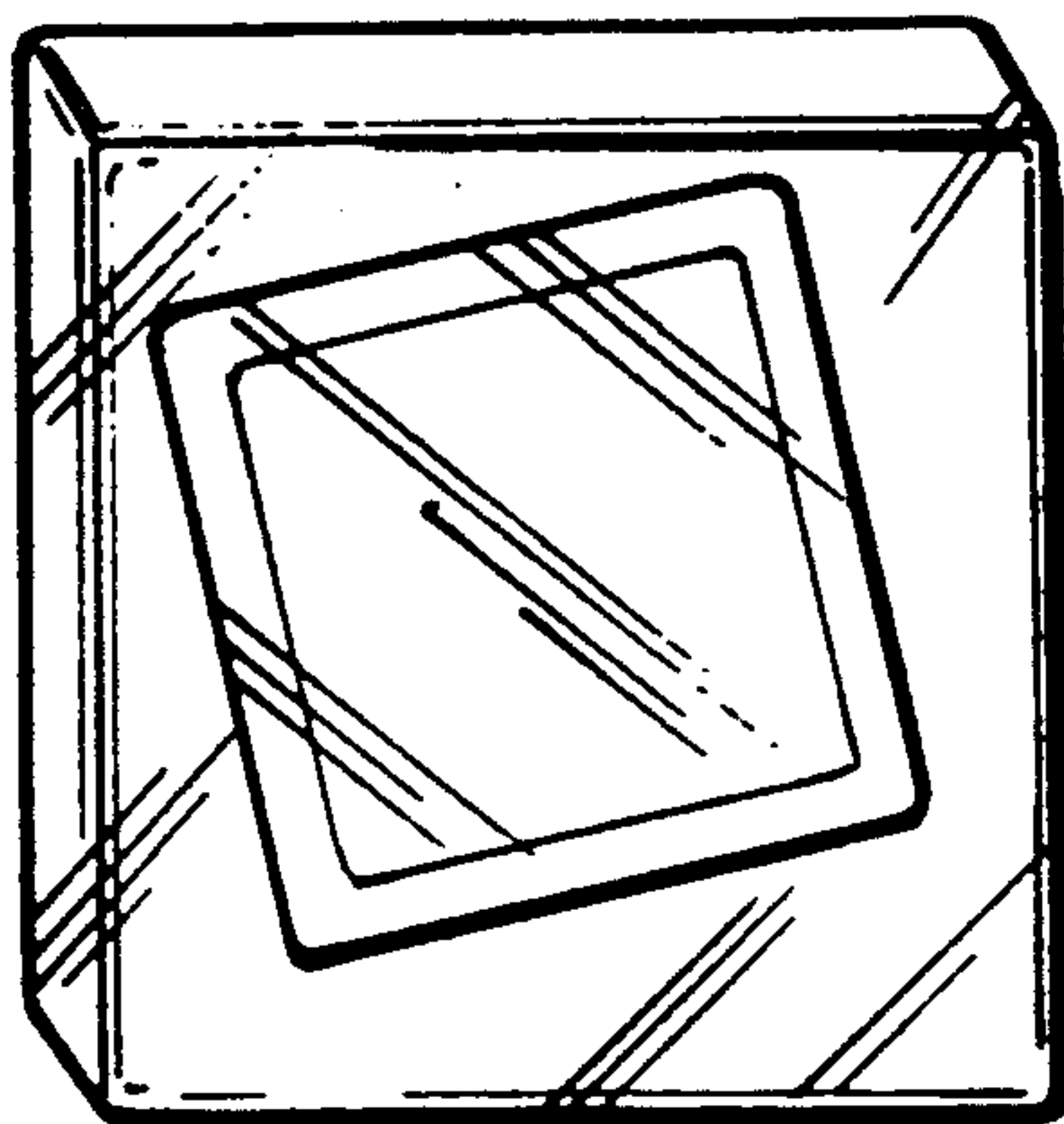

FIG. 8