



US00D325053S

United States Patent [19]

[11] Patent Number: **Des. 325,053**

Skov

[45] Date of Patent: **** Mar. 31, 1992**

[54] TOY CONSTRUCTION PIECE

4,184,285 1/1980 Arnau Pibet 446/93
4,964,834 10/1990 Myller 446/128

[75] Inventor: **Ib T. Skov**, Billund, Denmark

Primary Examiner—Bernard Ansher
Assistant Examiner—R. Barkai
Attorney, Agent, or Firm—Kane, Dalsimer, Sullivan,
Kurucz, Levy, Eisele and Richard

[73] Assignee: **Interlego A.G.**, Baar, Switzerland

[**] Term: **14 Years**

[21] Appl. No.: **621,910**

[57] **CLAIM**

[22] Filed: **Dec. 4, 1990**

The ornamental design for a toy construction piece, as shown and described.

[52] U.S. Cl. **D21/108**

[58] Field of Search **D21/108; 446/93, 94,
446/128, 121**

DESCRIPTION

[56] **References Cited**

U.S. PATENT DOCUMENTS

- D. 285,100 8/1986 Volpe D21/108
- D. 285,705 9/1986 Dideriksen D21/108
- D. 304,046 10/1989 Knudsen D21/108
- D. 311,939 11/1990 Andersen D21/108

FIG. 1 is a top perspective view of a toy construction piece showing my new design;
FIG. 2 is a front elevational view thereof;
FIG. 3 is a right side elevational view thereof, the side opposite being a mirror image;
FIG. 4 is a rear elevational view thereof;
FIG. 5 is a top plan view thereof; and,
FIG. 6 is a bottom plan view thereof.

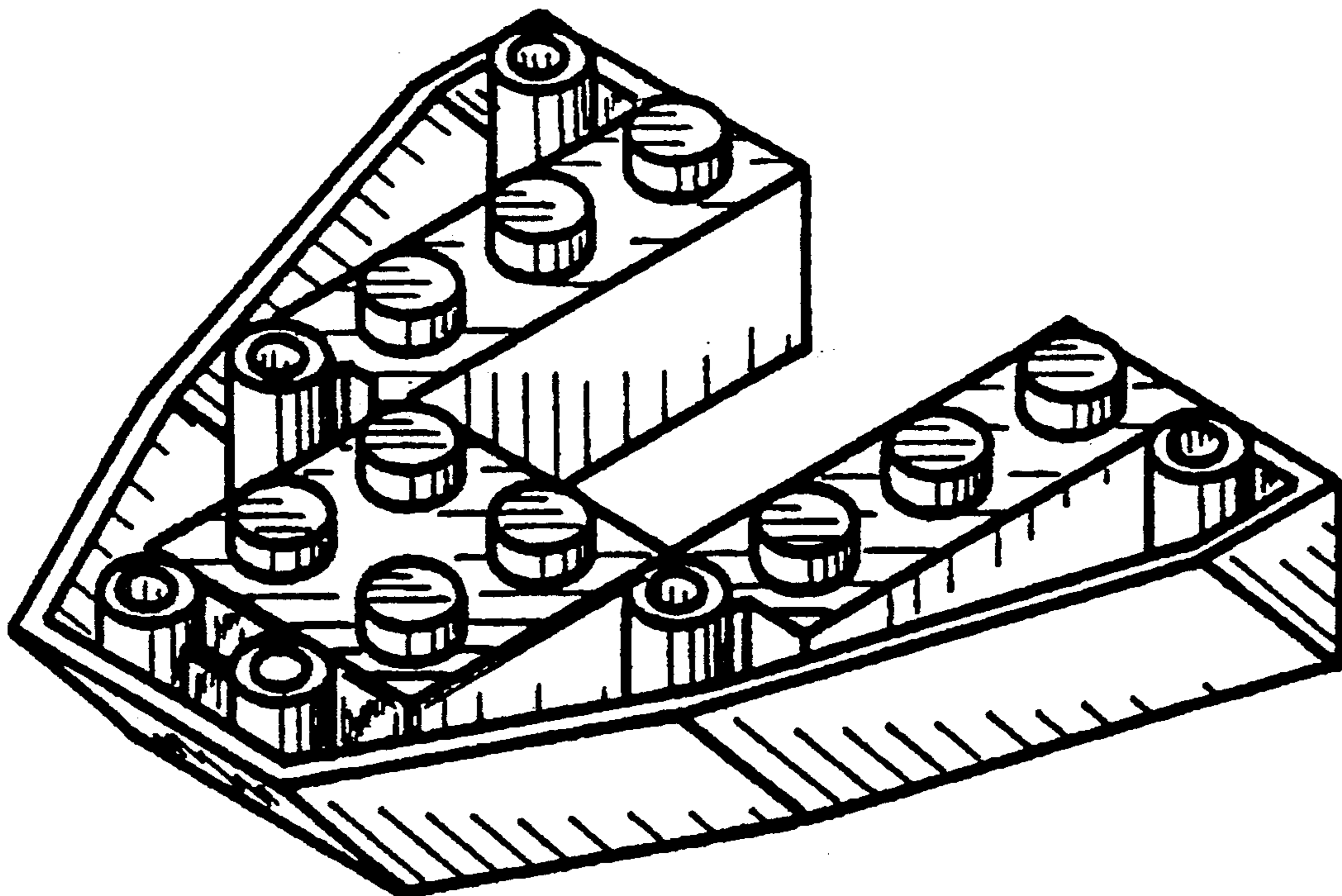

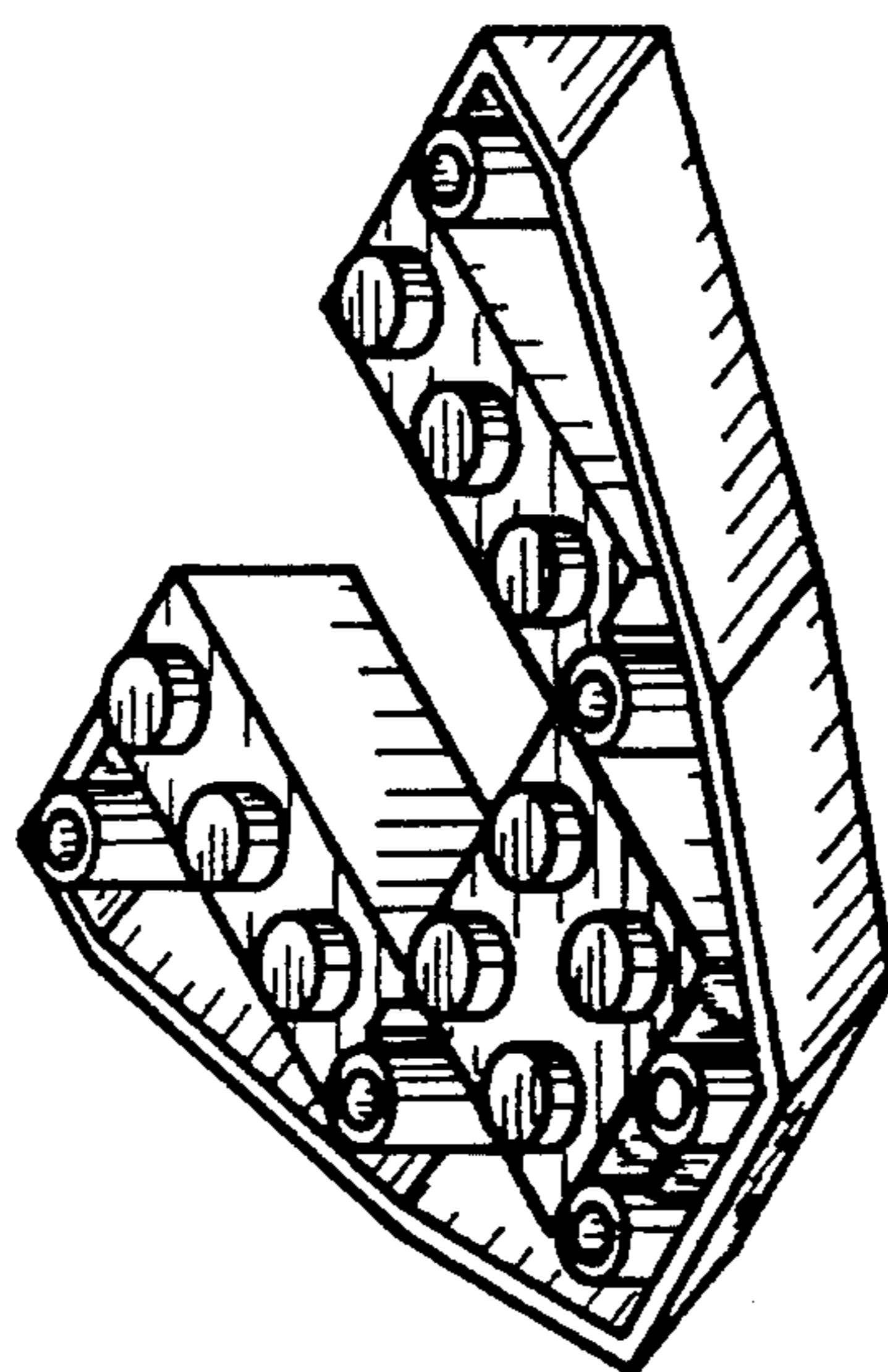

FIG. 1

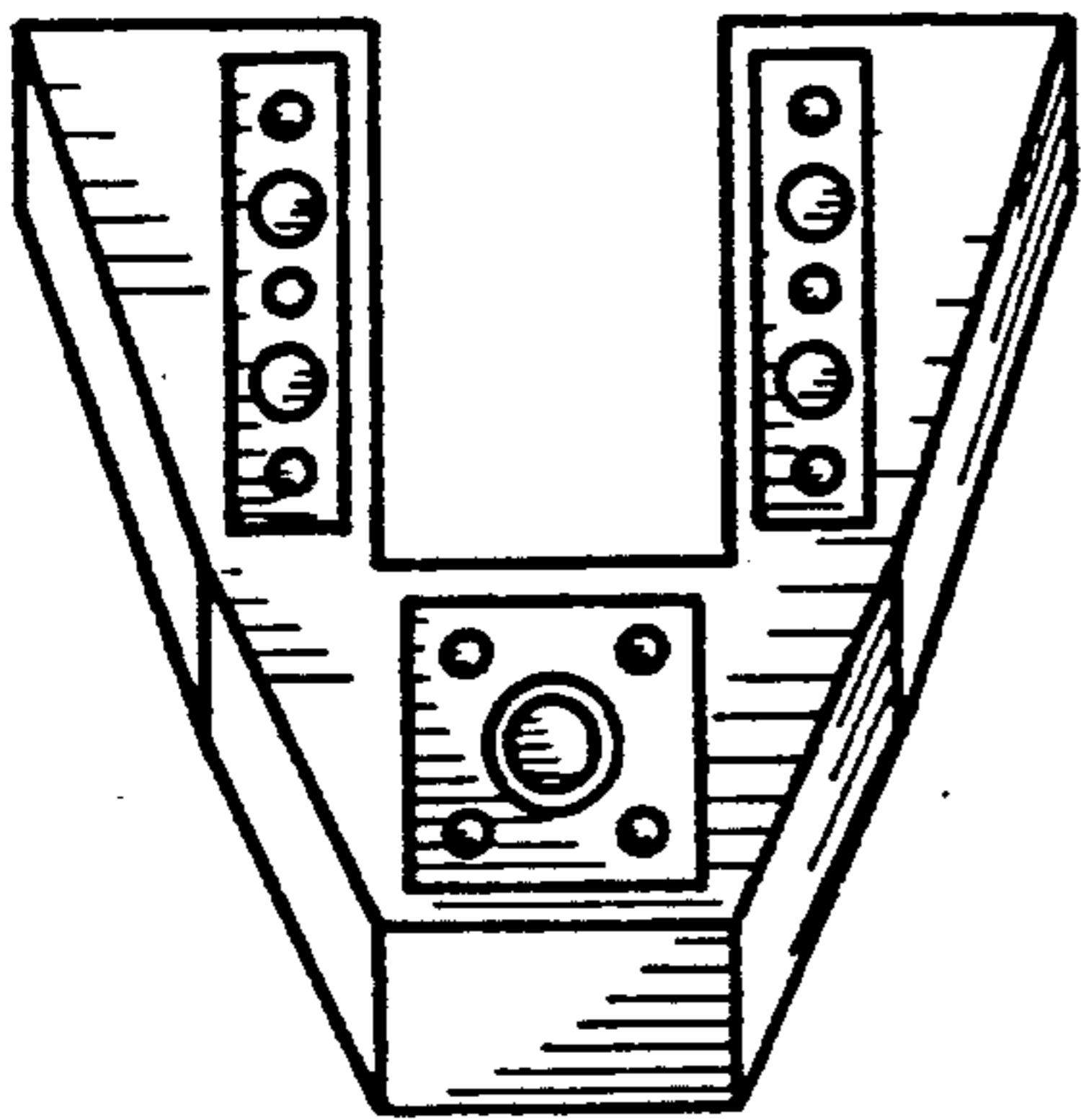

FIG. 6

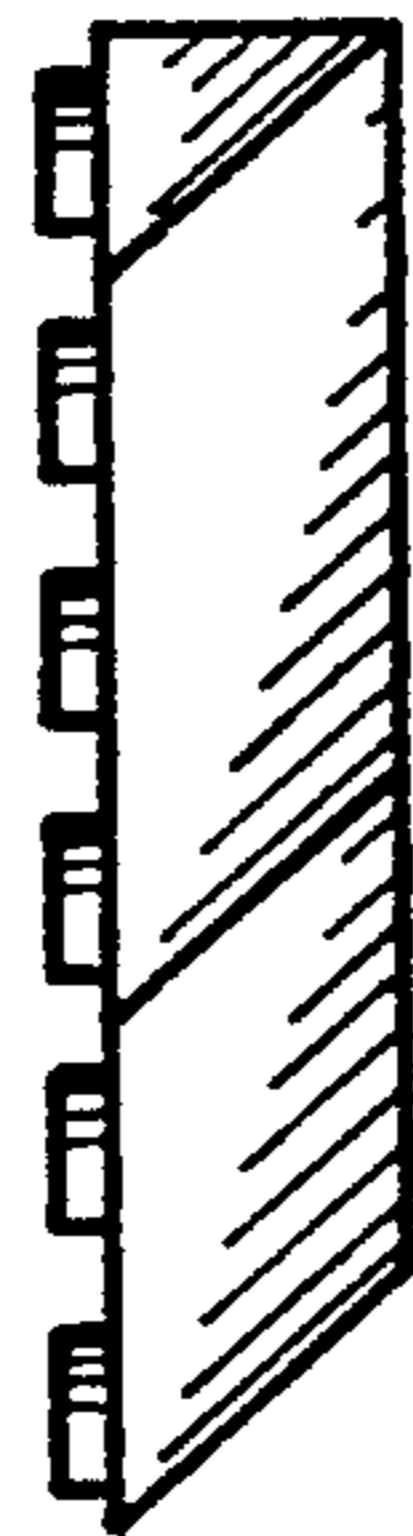

FIG. 3

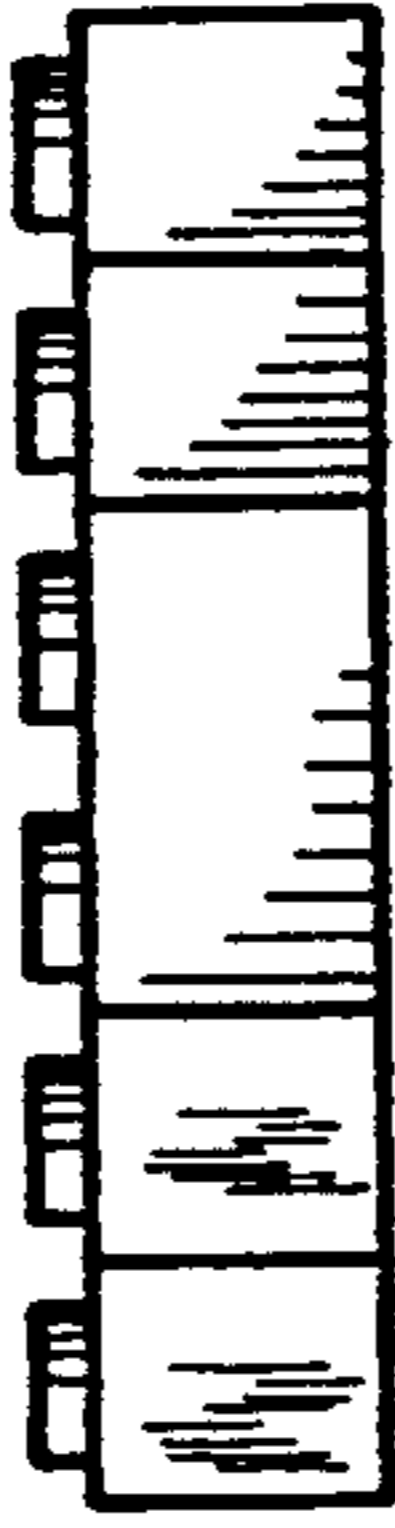

FIG. 2

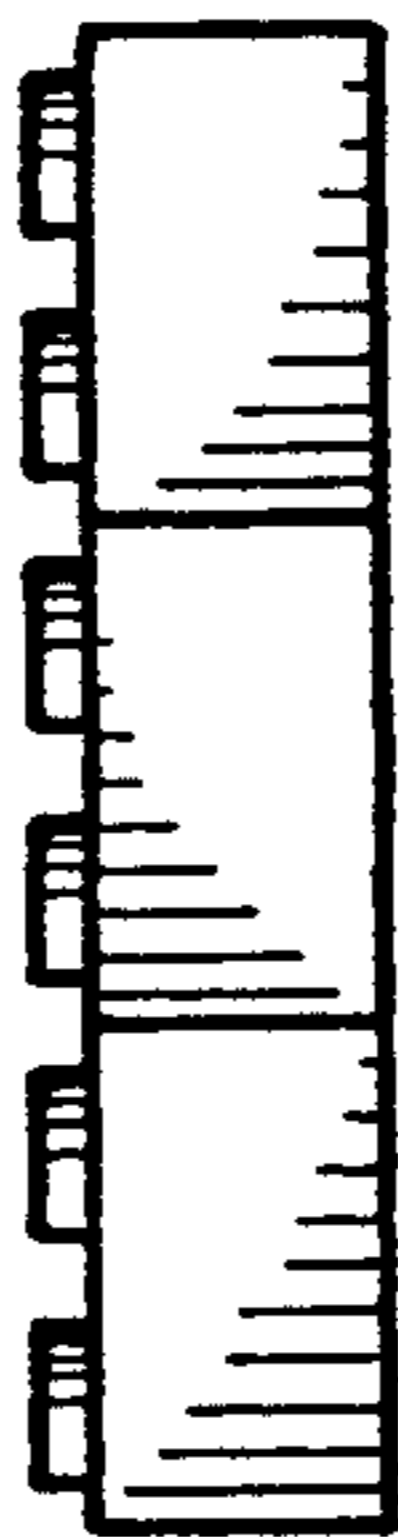

FIG. 4

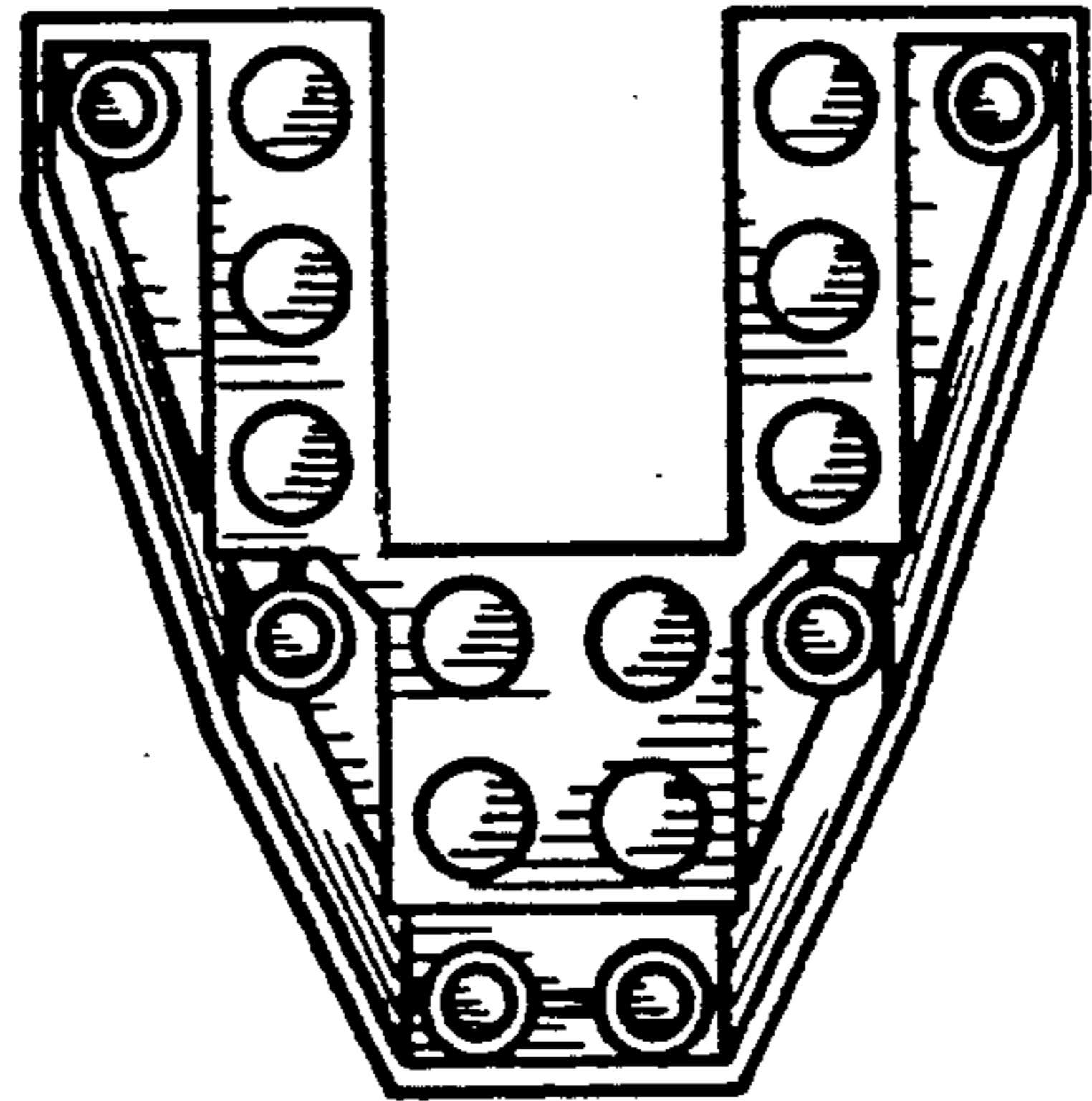

FIG. 5