



US00D324947S

United States Patent [19]

[11] Patent Number: **Des. 324,947**

Kuwabara

[45] Date of Patent: **** Mar. 31, 1992**

[54] **HOLDER FOR WAX USED IN COATING EMBROIDERY THREAD OR THE LIKE**

[75] Inventor: **Junichi Kuwabara, Amagasaki, Japan**

[73] Assignee: **Clover Mfg. Co., Ltd., Osaka, Japan**

[**] Term: **14 Years**

[21] Appl. No.: **434,162**

[22] Filed: **Nov. 13, 1989**

[30] **Foreign Application Priority Data**

May 10, 1989 [JP] Japan 1-17136

[52] U.S. Cl. **D3/20; D3/26; D3/30.1**

[58] Field of Search **D3/30.1, 18, 20, 23, D3/26, 106; D14/253; 223/106, 108, 120; D6/518, 522, 523**

[56] **References Cited**

U.S. PATENT DOCUMENTS

- D. 238,629 2/1976 Tibbetts D3/106
- D. 254,069 1/1980 Haley D14/253
- D. 257,189 10/1980 Winbauer D3/106
- D. 281,544 12/1985 Michell et al. D3/26
- D. 293,106 12/1987 Renslow D14/253
- 367,035 7/1887 Fox 223/108
- 810,292 1/1906 Meaker 223/106
- 4,437,618 3/1984 Boyle D3/20

OTHER PUBLICATIONS

The Illustrated Encyclopedia of Crafts: ©1978; p. 1966, "beeswax" disc (center of page).

Primary Examiner—A. Hugo Word
Assistant Examiner—Celia A. Murphy
Attorney, Agent, or Firm—William H. Eilberg

[57] **CLAIM**

The ornamental design for a holder used for wax in coating embroidery thread or the like, as shown and described.

DESCRIPTION

FIG. 1 is a perspective view of a holder for wax used in coating embroidery thread or the like showing my new design;

FIG. 2 is a front elevational view thereof;

FIG. 3 is a rear elevational view thereof;

FIG. 4 is a right side elevational view thereof;

FIG. 5 is a left side elevational view thereof;

FIG. 6 is a top plan view thereof;

FIG. 7 is a bottom plan view thereof;

FIG. 8 is a sectional view taken on line 8—8 of FIG. 2;

FIG. 9 is a sectional view taken on line 9—9 of FIG. 6;

and,

FIG. 10 is a perspective view as shown in FIG. 1; the broken lines partially showing a wax disc and a segment of thread being for illustrative purposes only and forming no part of the claimed design.

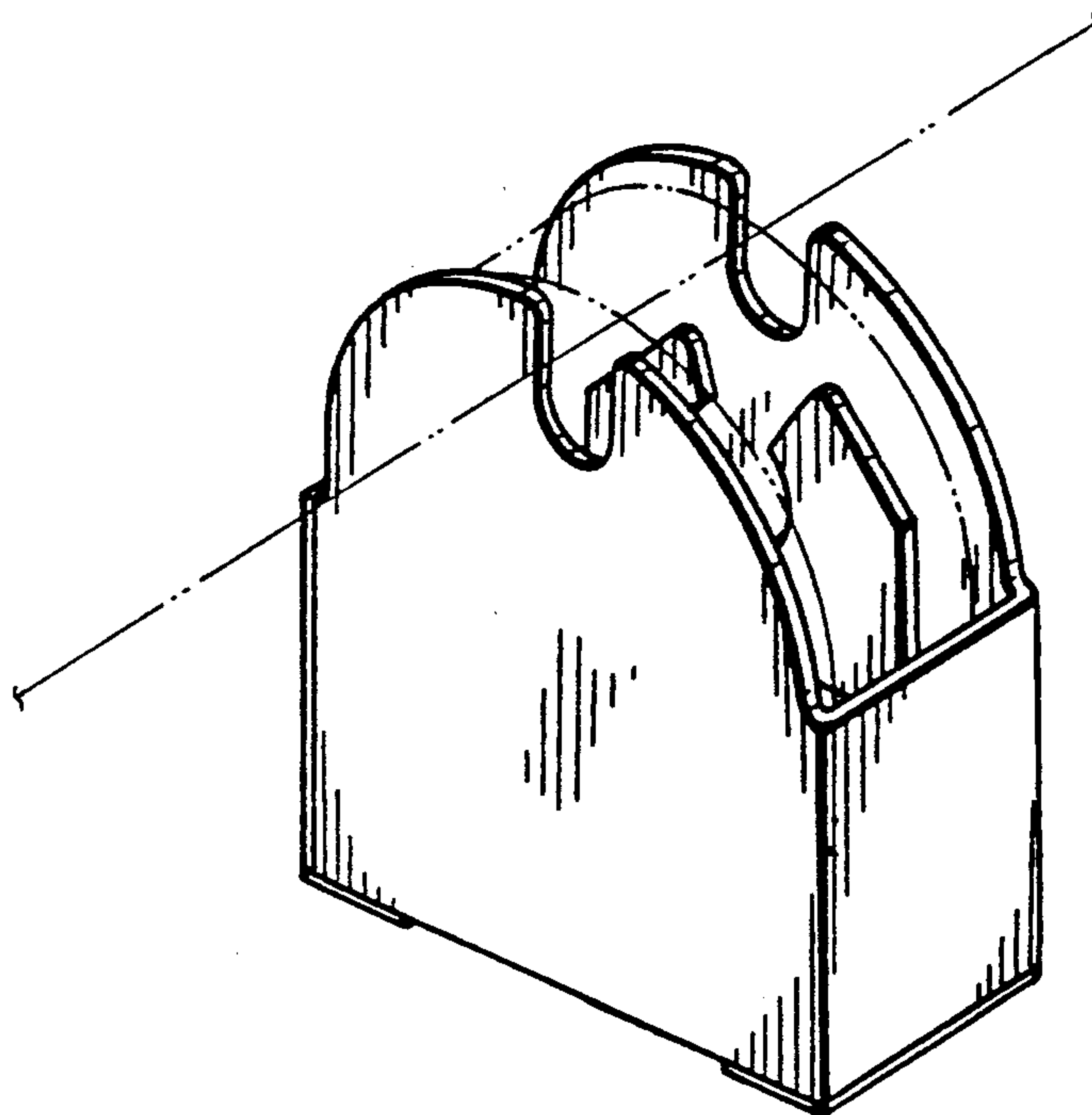

Fig. 1

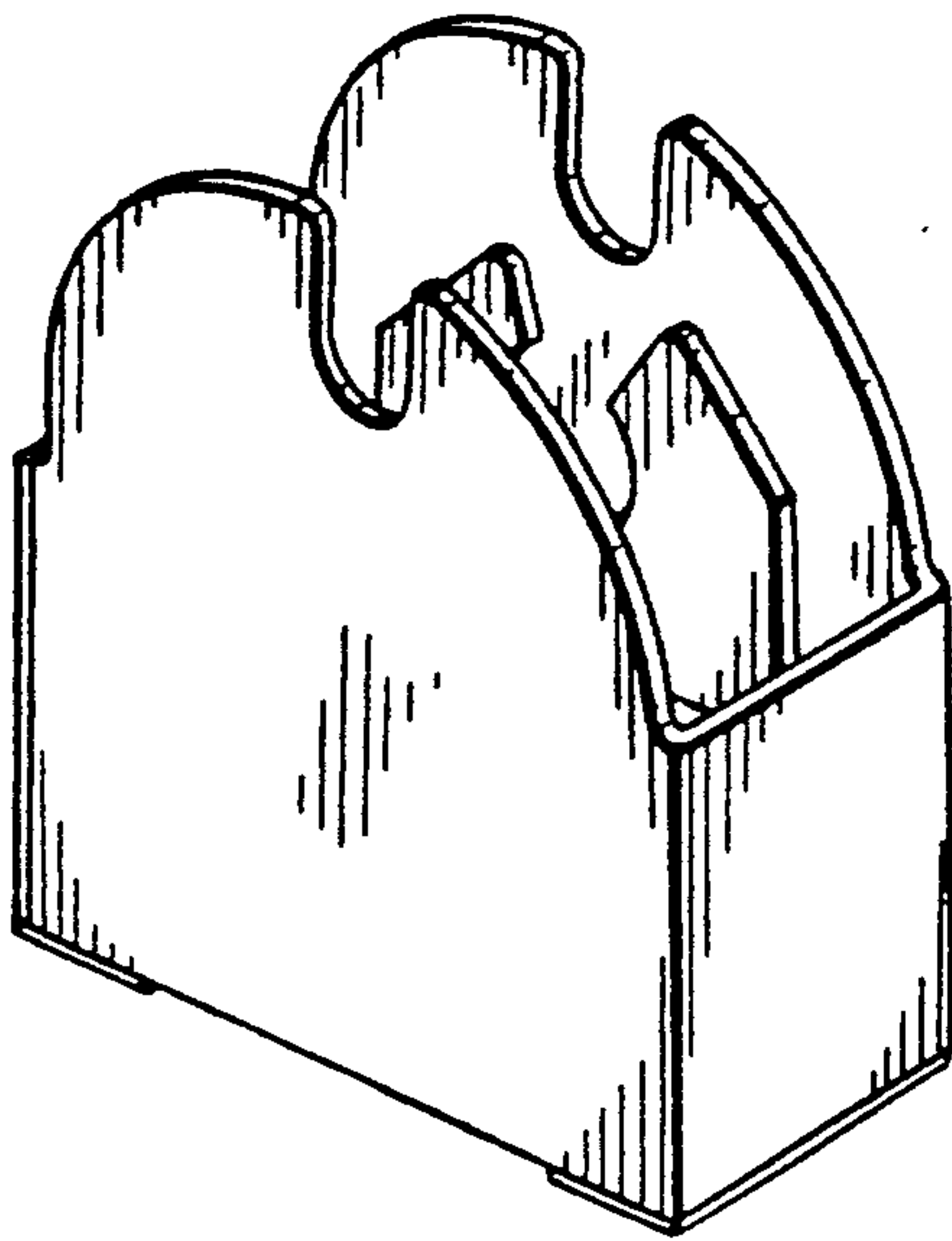

Fig. 2

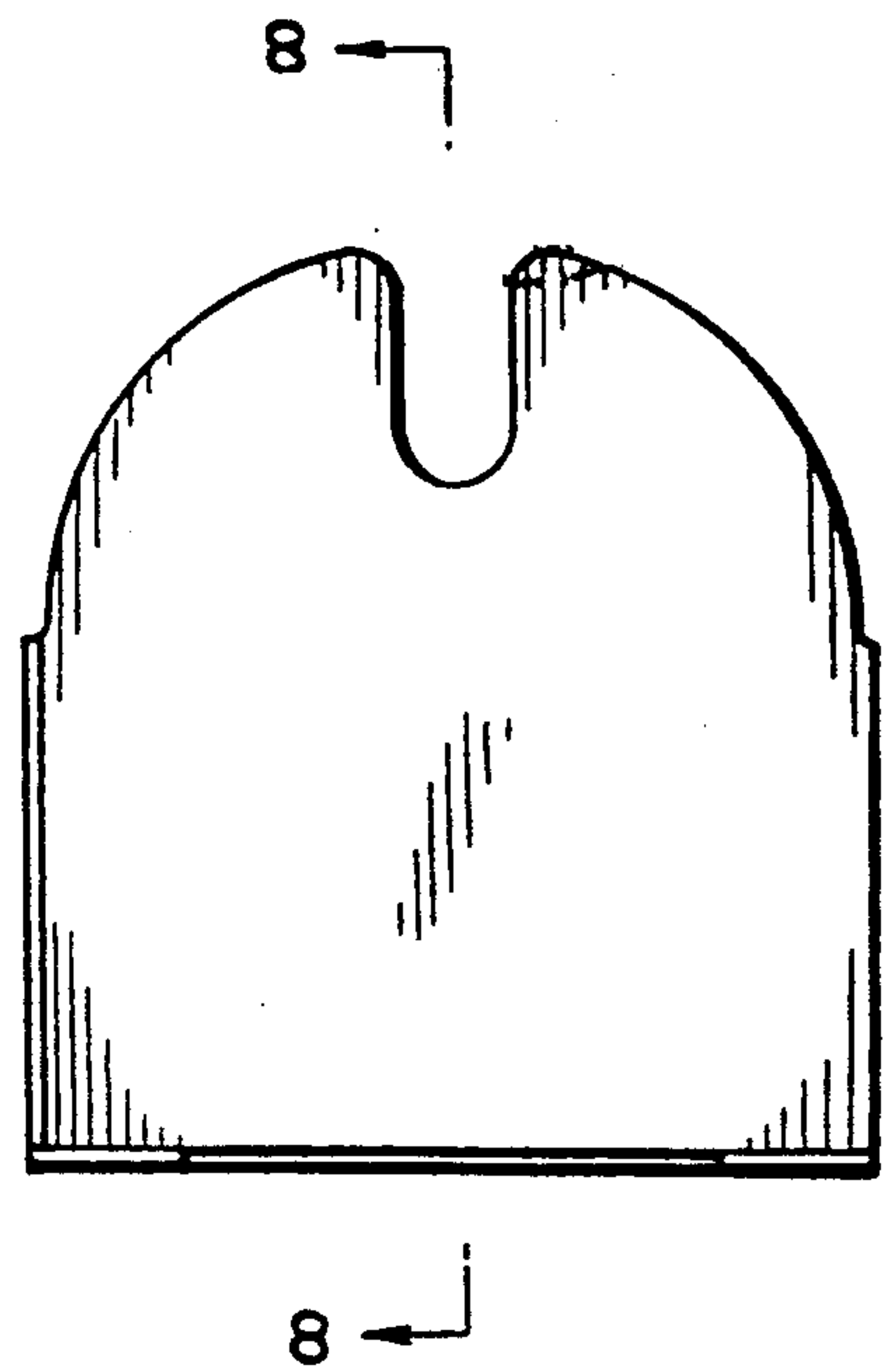

Fig. 3

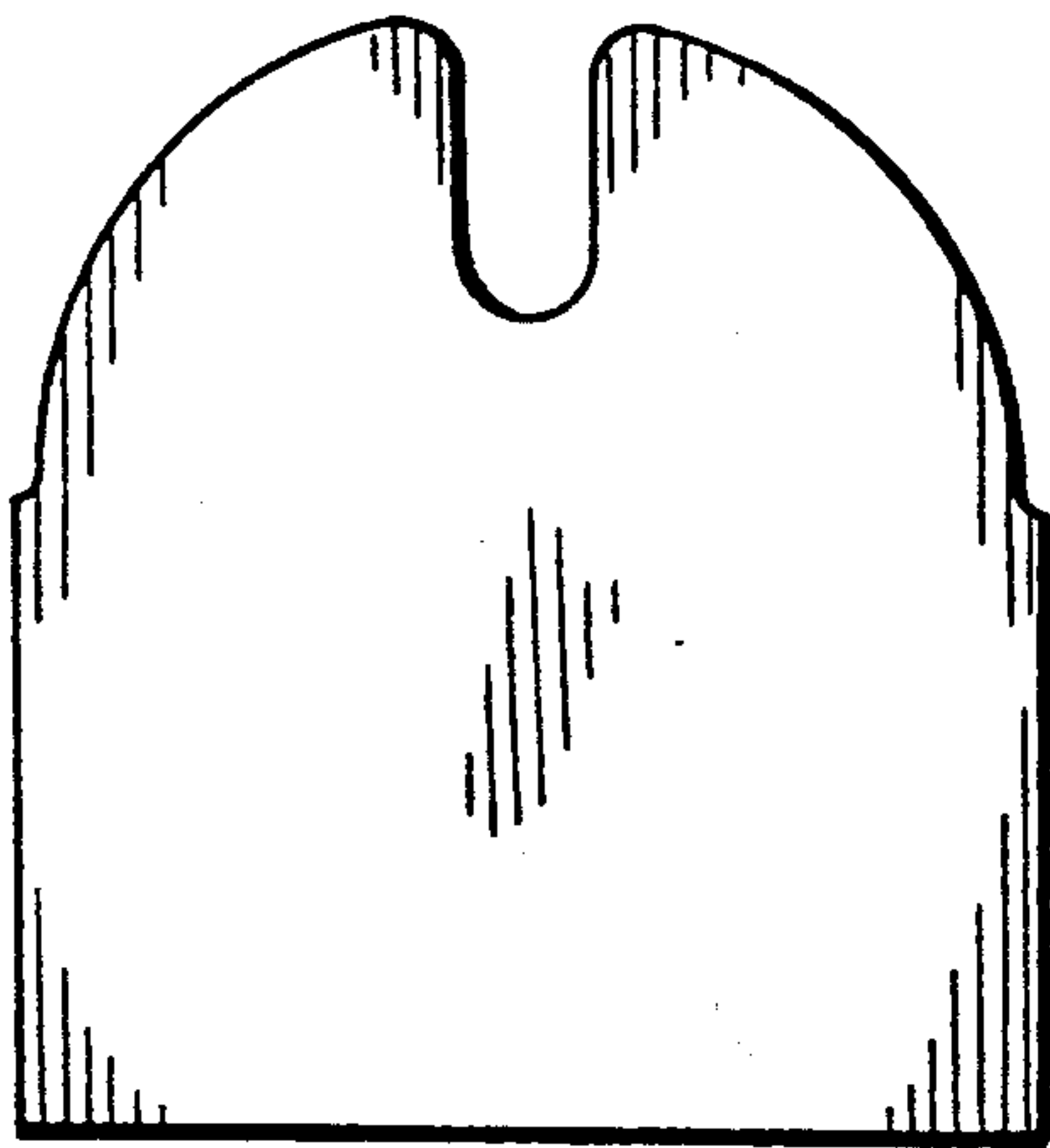

Fig. 4



Fig. 5

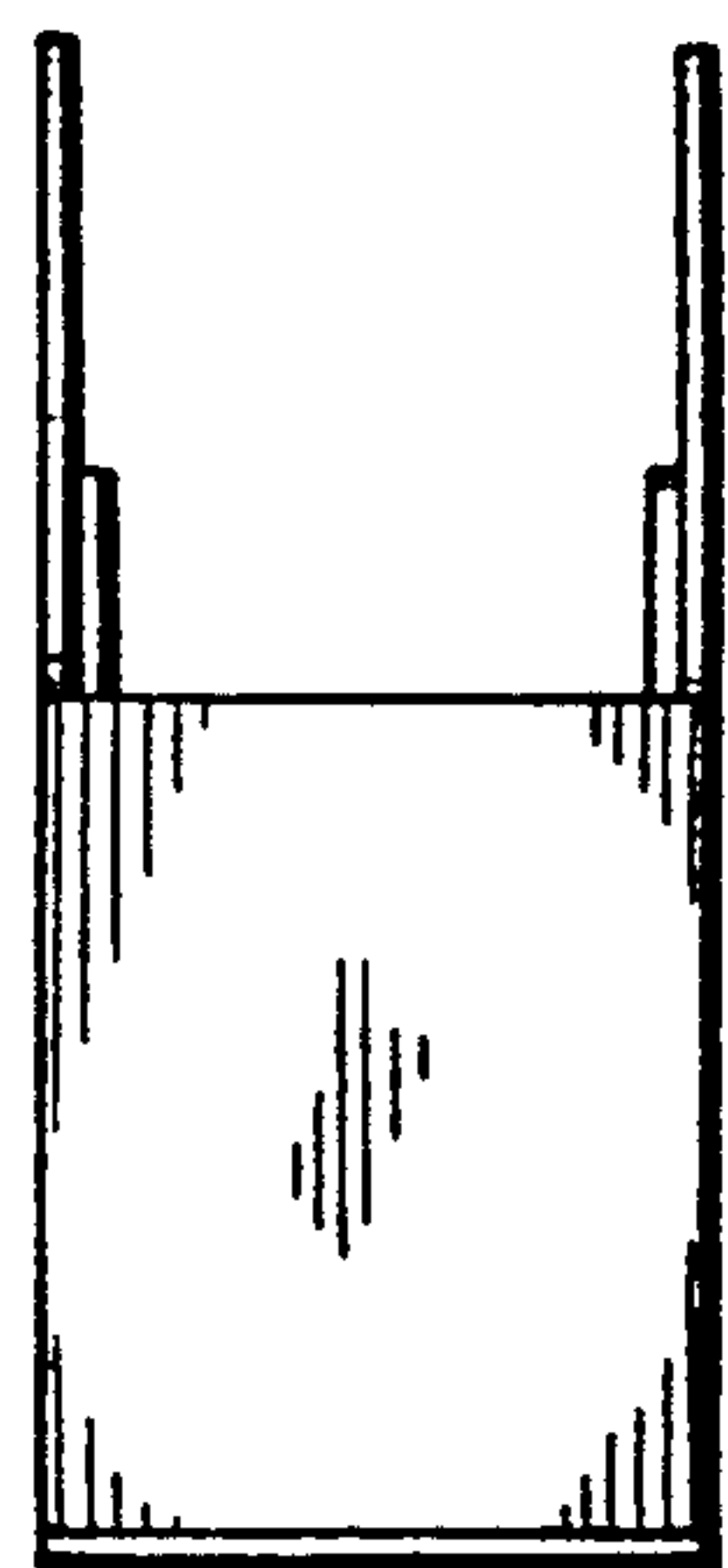

Fig. 6



Fig. 7

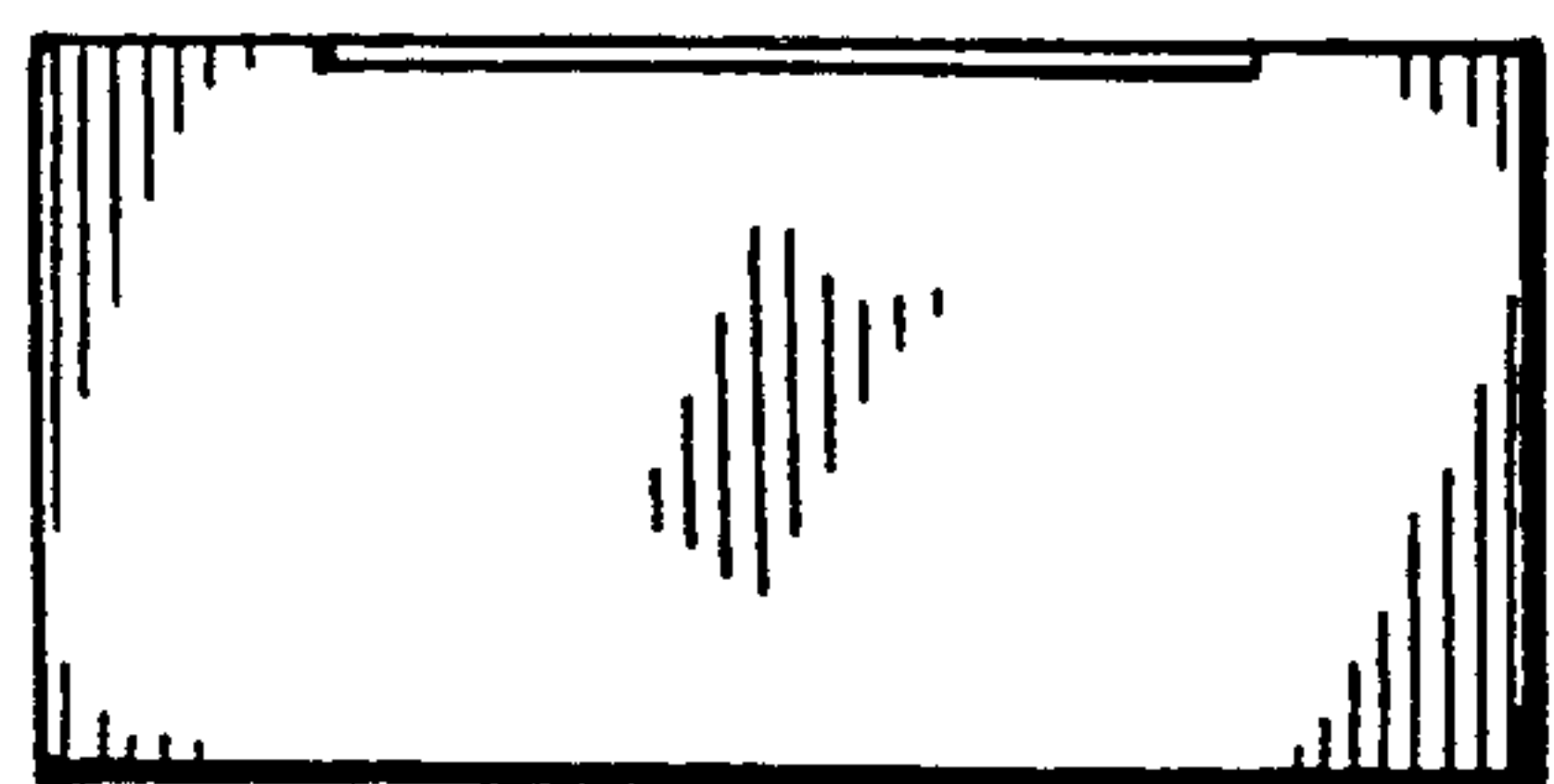

Fig. 8

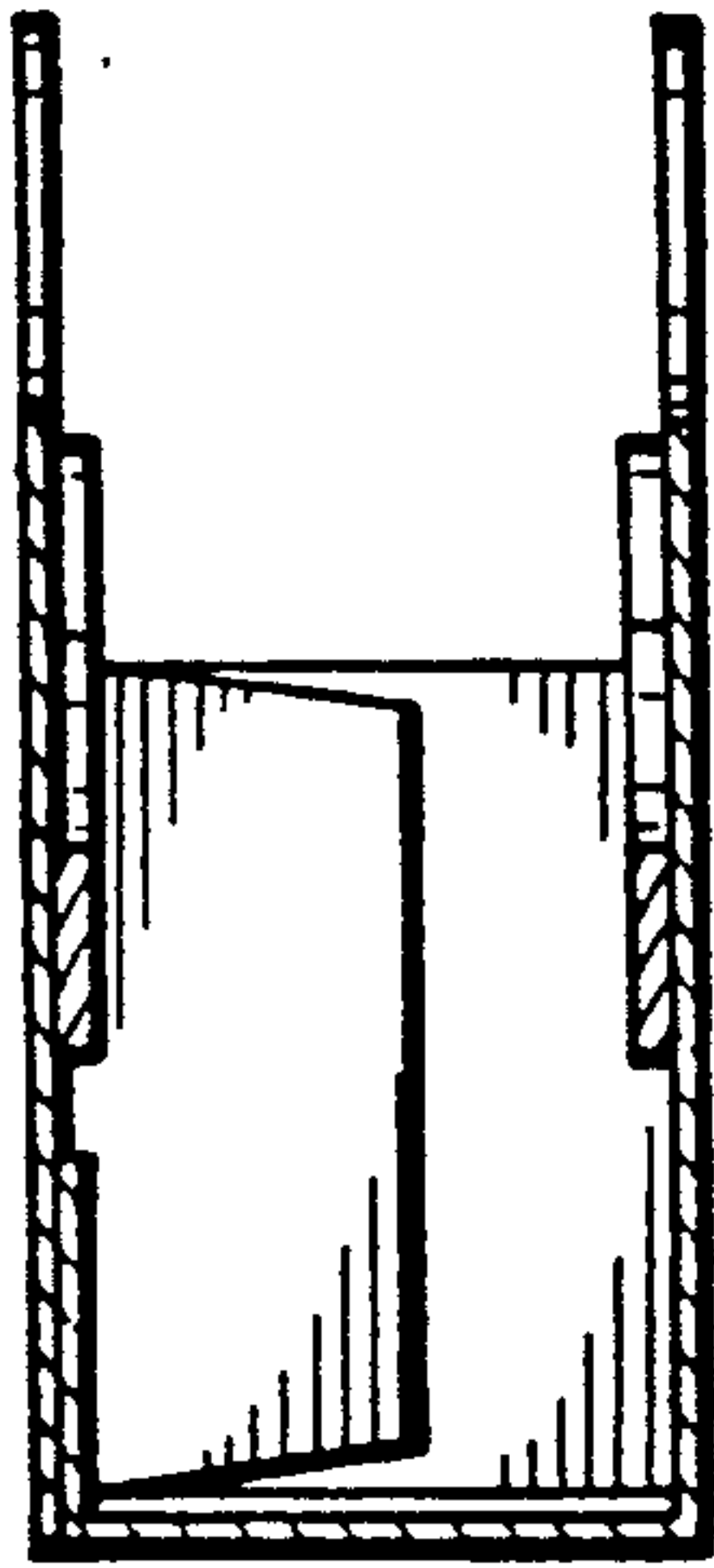

Fig. 9

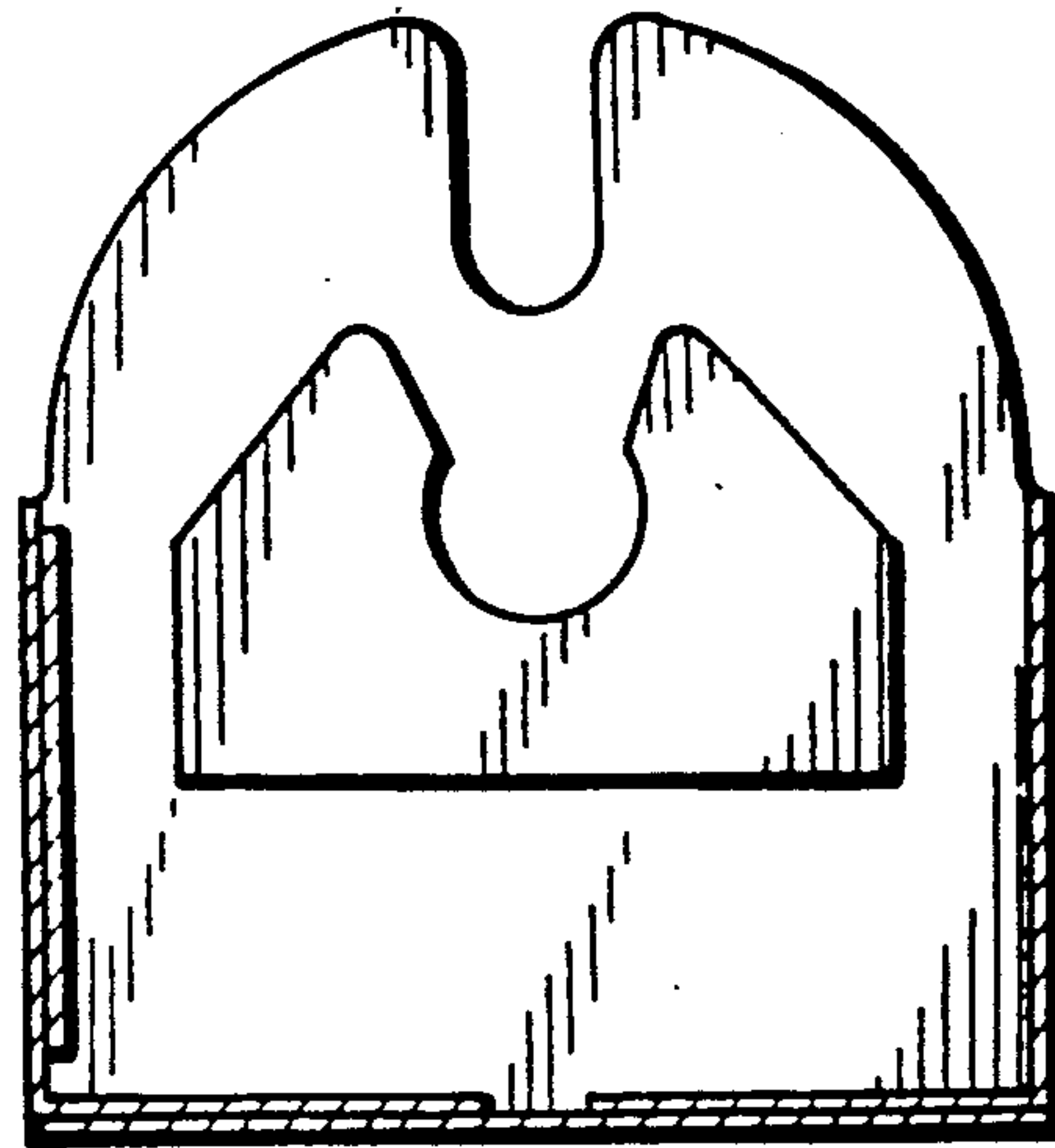

Fig. 10

