



US00D324795S

United States Patent [19]

[11] Patent Number: **Des. 324,795**

Hoover et al.

[45] Date of Patent: **** Mar. 24, 1992**

[54] **BEVERAGE DISPENSER**

D. 311,844 11/1990 Chase et al. D7/311 X
3,445,039 5/1969 Brodsky et al. D7/309 X

[75] Inventors: **George H. Hoover, Marietta; Roger C. Whigham, Atlanta; Annie T. Ellis, Smyrna; Phillip J. Snoke; Lionel D. Gillespie, both of Atlanta; Devin L. Moore, Decatur, all of Ga.**

OTHER PUBLICATIONS

HFD, Jan. 16, 1989, p. 131, bottom left "DeLonghi Bar Espresso/Cappuccino Maker".

Primary Examiner—Winifred E. Herrmann

[73] Assignee: **The Coca-Cola Company, Atlanta, Ga.**

[57] **CLAIM**

The ornamental design for a beverage dispenser, as shown and described.

[**] Term: **14 Years**

[21] Appl. No.: **355,383**

DESCRIPTION

[22] Filed: **May 23, 1989**

FIG. 1 is a top, front, left-side perspective view of a beverage dispenser showing our new design; FIG. 2 is a top, plan view thereof; FIG. 3 is a left-side elevational view thereof; FIG. 4 is a front elevational view thereof; FIG. 5 is a rear elevational view thereof; FIG. 6 is a top, front, right side perspective showing a fragmentary portion thereof with a control panel lid in an open position; and, FIG. 7 is a bottom plan view thereof.

[52] U.S. Cl. **D7/308; D7/311**

[58] Field of Search **D7/300, 308, 311, 309, D7/305, 312**

[56] **References Cited**

U.S. PATENT DOCUMENTS

D. 185,833 8/1959 Bruntjen D7/311
D. 235,816 7/1975 Hall D7/308

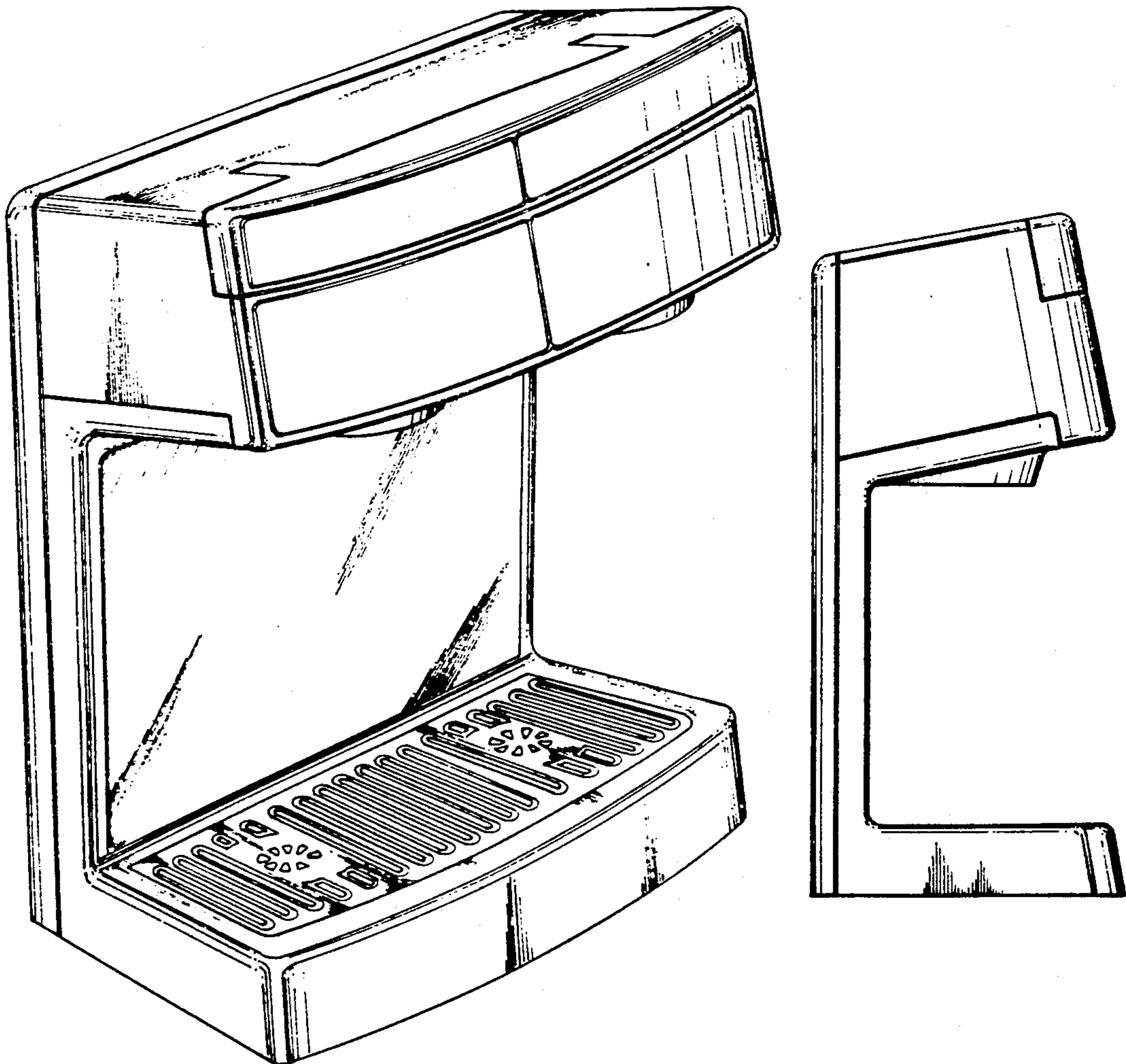

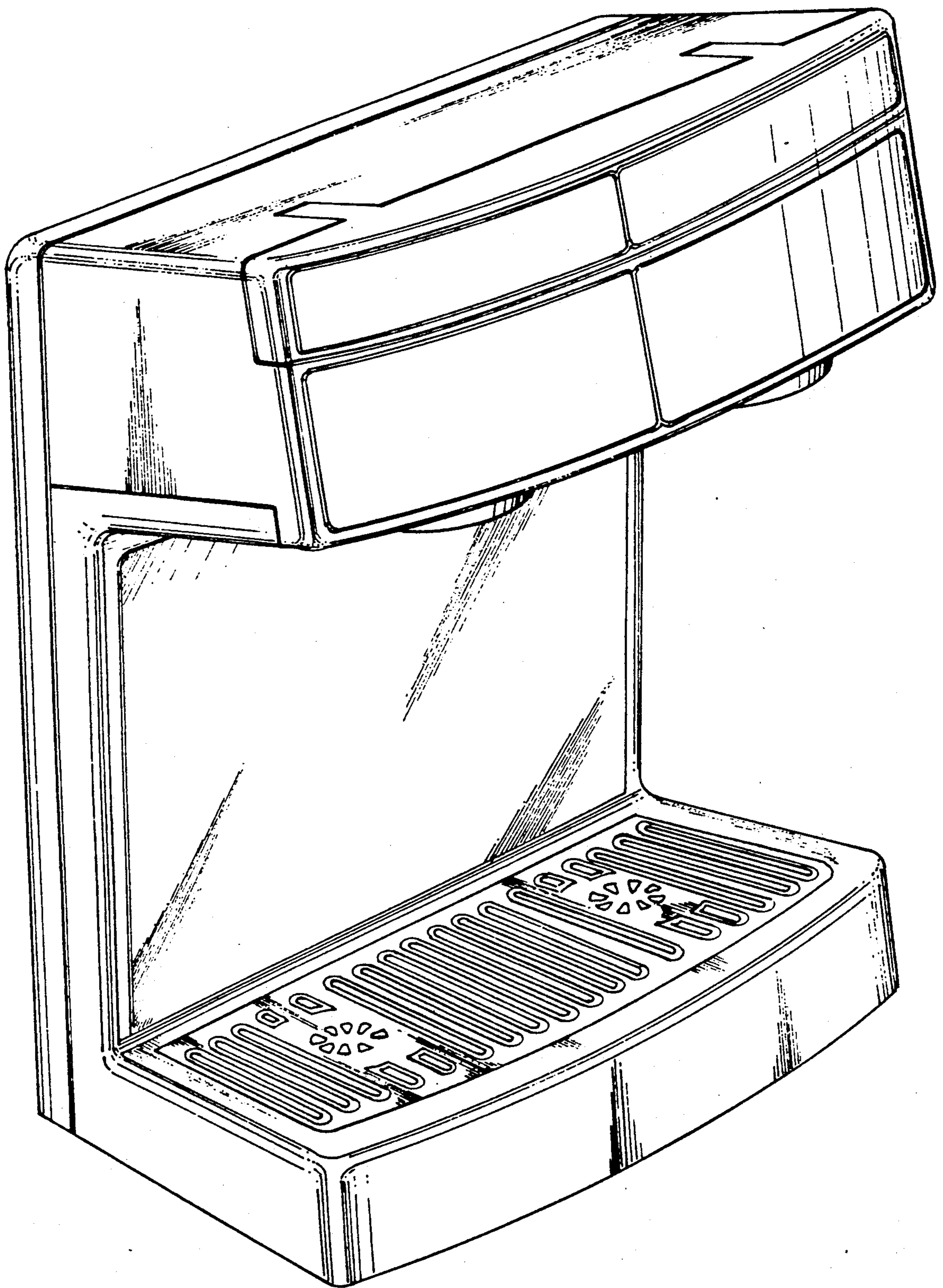

FIG. 1

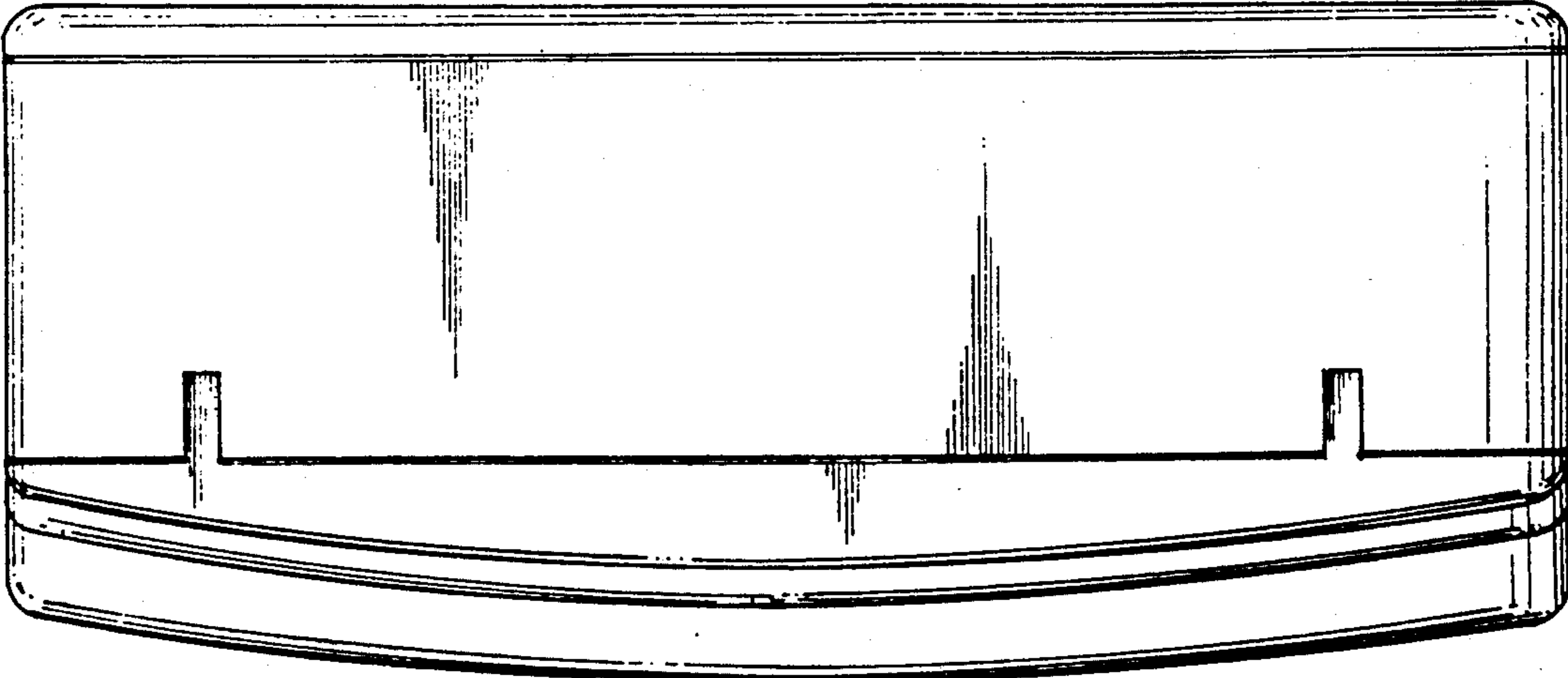

FIG. 2

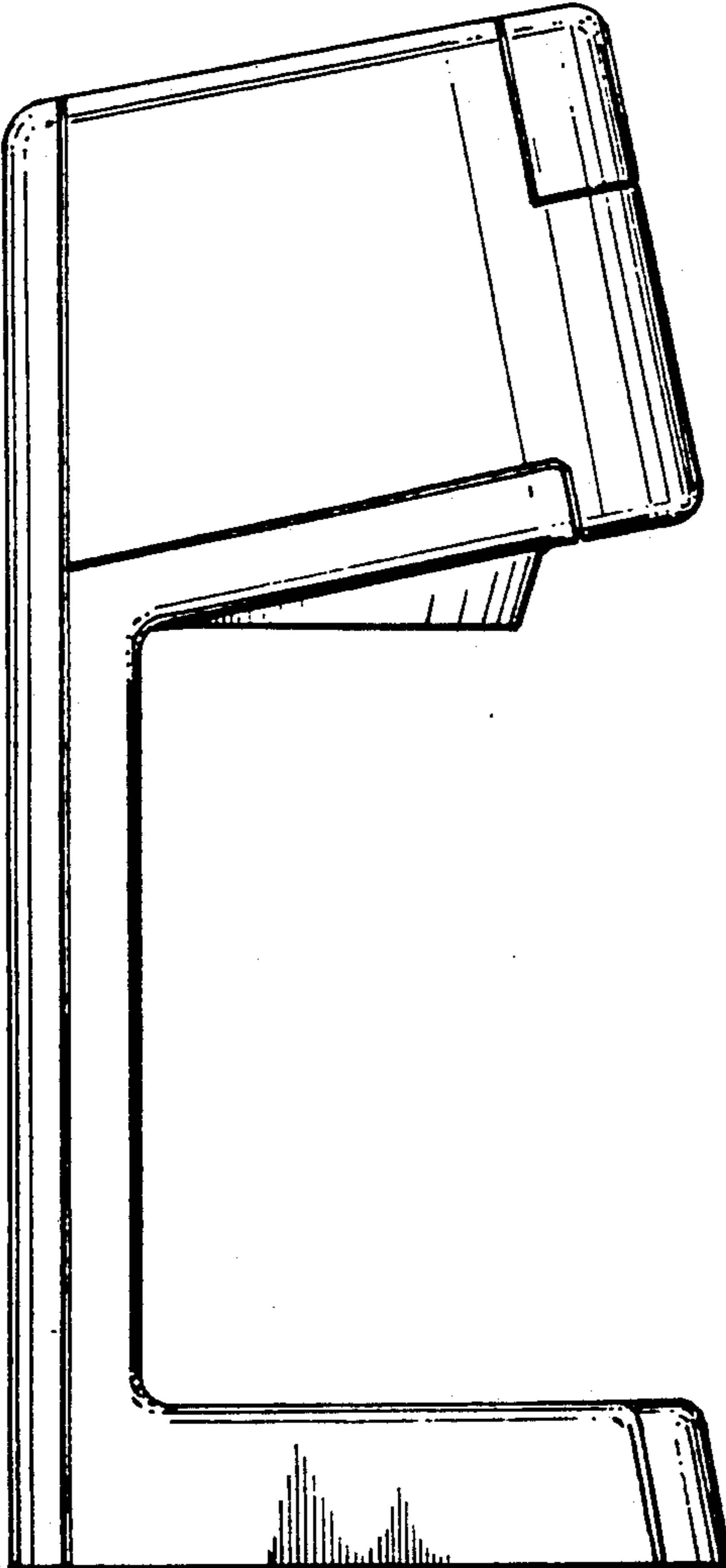

FIG. 3

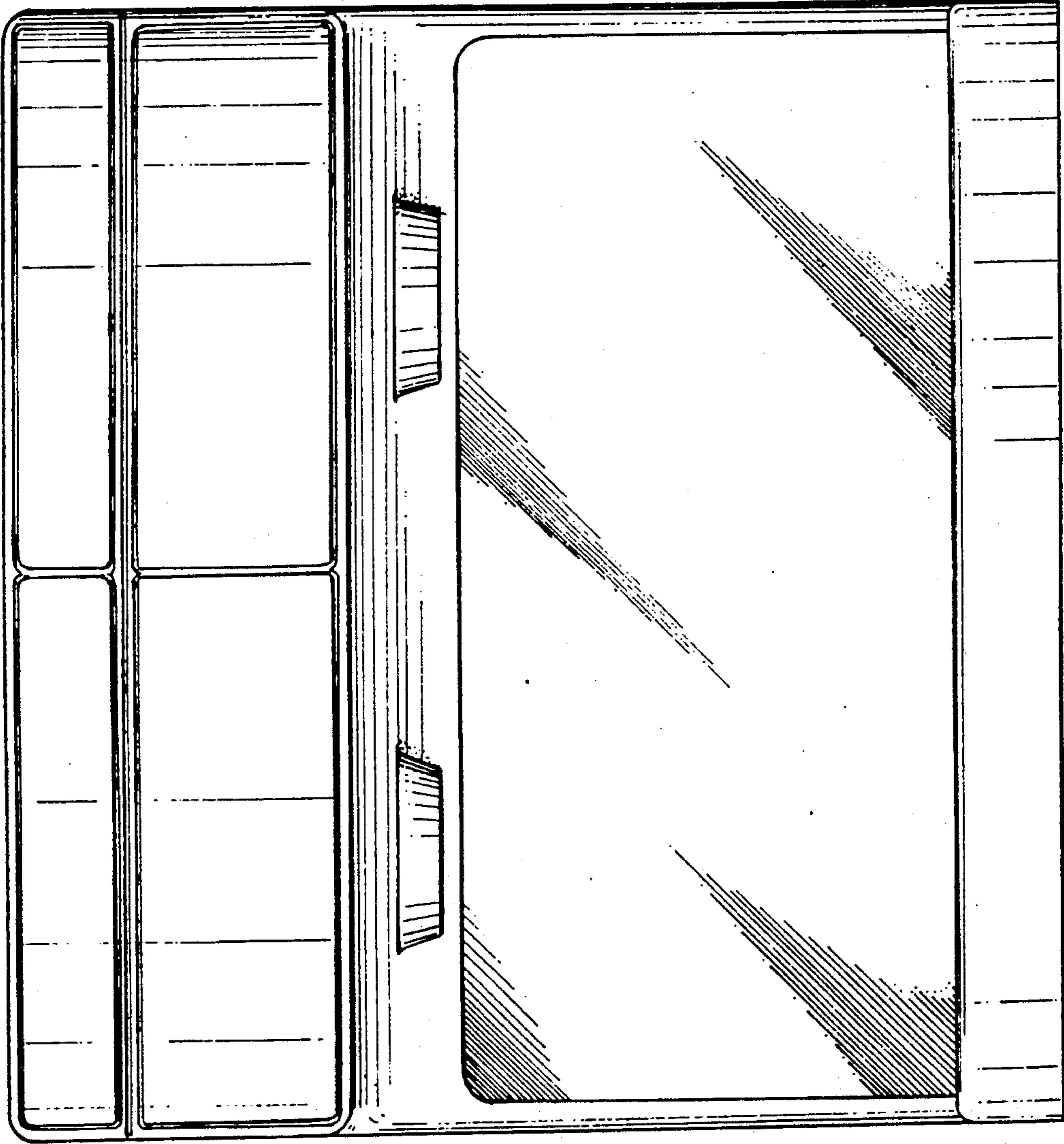

FIG. 4

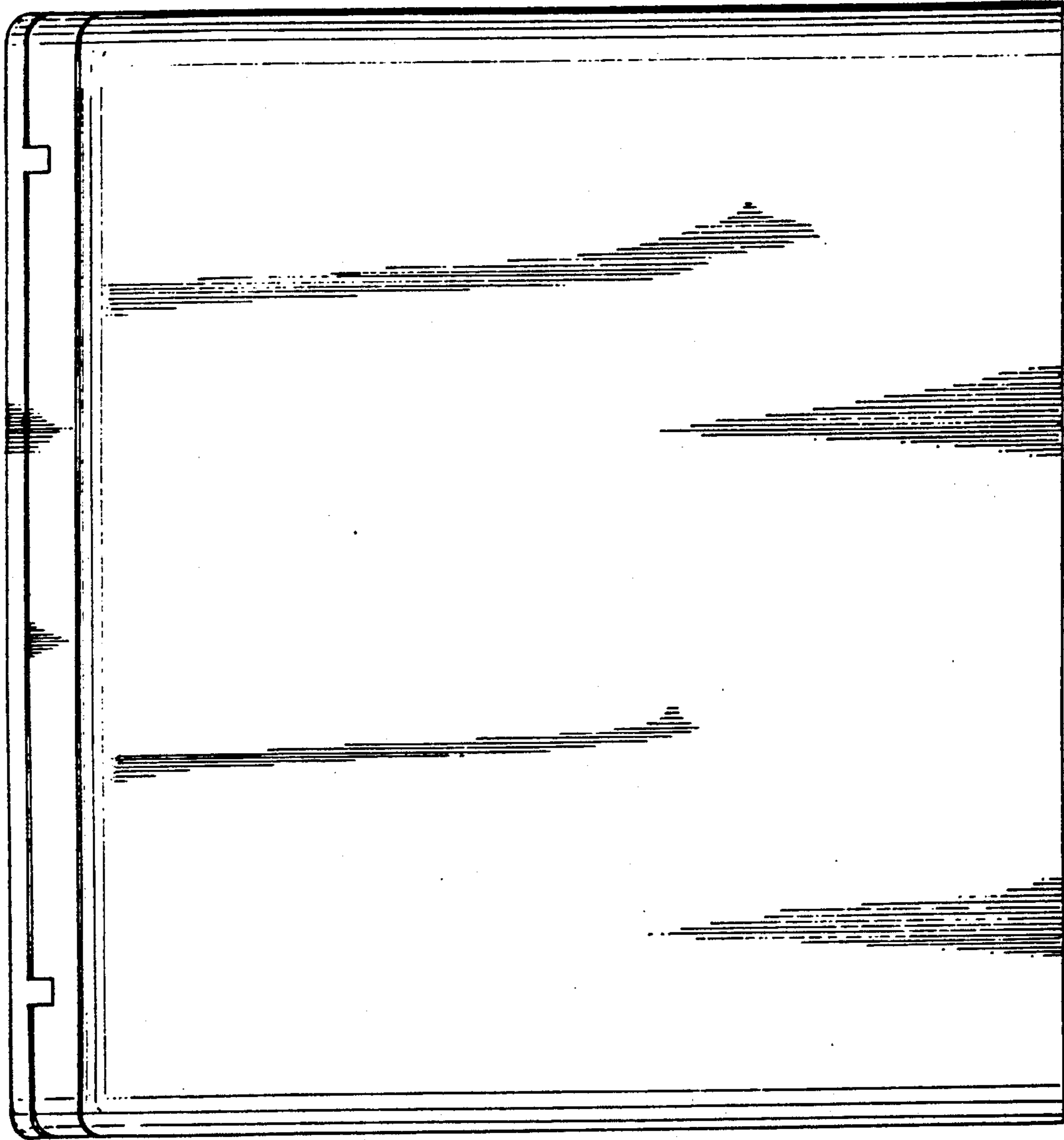

FIG. 5

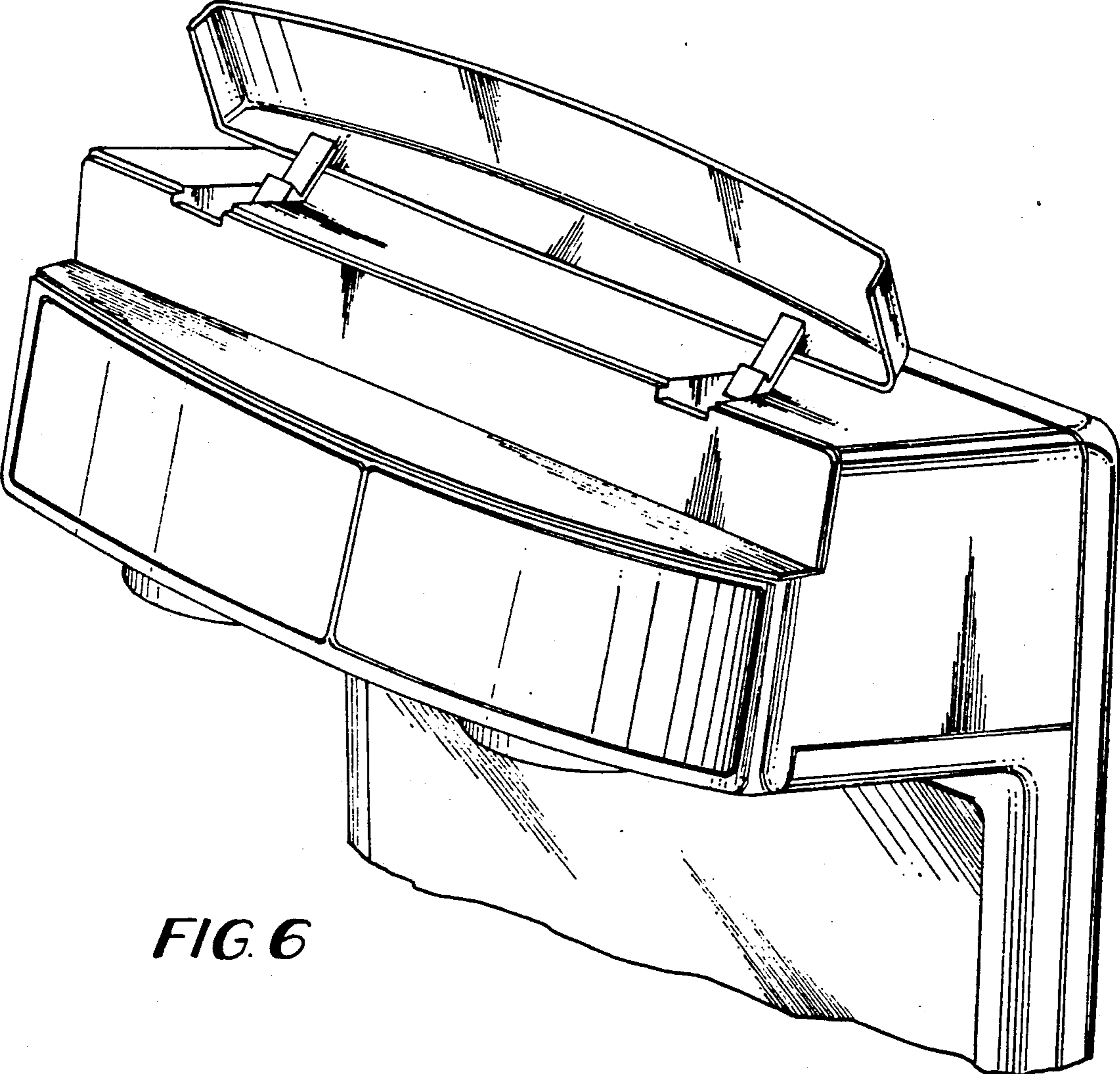

FIG. 6

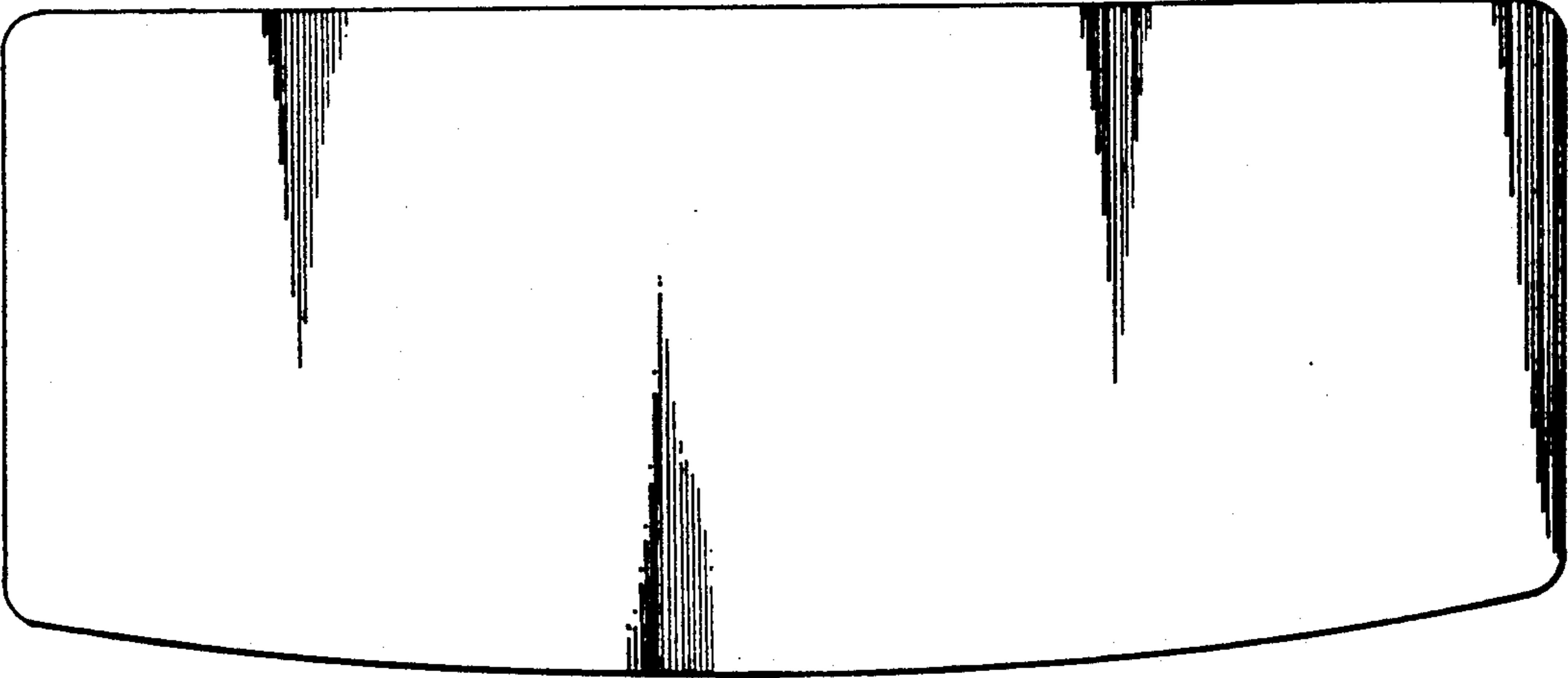

FIG. 7