



US00D324794S

United States Patent [19]

[11] Patent Number: **Des. 324,794**

Whitright

[45] Date of Patent: **** Mar. 24, 1992**

[54] STRAW

[76] Inventor: **Curt E. Whitright**, 11287 Thwing Rd., Chardon, Ohio 44024

[**] Term: **14 Years**

[21] Appl. No.: **325,506**

[22] Filed: **Mar. 20, 1989**

[52] U.S. Cl. **D7/300.2**

[58] Field of Search **D7/300.2; 239/33; 215/1 A, 229**

[56] **References Cited**

U.S. PATENT DOCUMENTS

- D. 134,916 1/1943 Duberstein D9/315 X
- D. 220,238 3/1971 Bernstein D7/300.2

OTHER PUBLICATIONS

Hong Kong Enterprise, 4/83, p. 360, Straw "E".

Primary Examiner—Terry A. Pfeffer
Attorney, Agent, or Firm—Oldham & Oldham Co.

[57] **CLAIM**

The ornamental design for a straw, as shown and described.

DESCRIPTION

FIG. 1 is a perspective view of a straw showing my new design;

FIG. 2 is a front elevational view thereof;

FIG. 3 is a perspective view of an alternate embodiment of FIG. 1;

FIG. 4 is a front elevational view of FIG. 3;

FIG. 5 is a perspective view of an alternate embodiment of FIG. 1; and,

FIG. 6 is a front elevational view of FIG. 5.

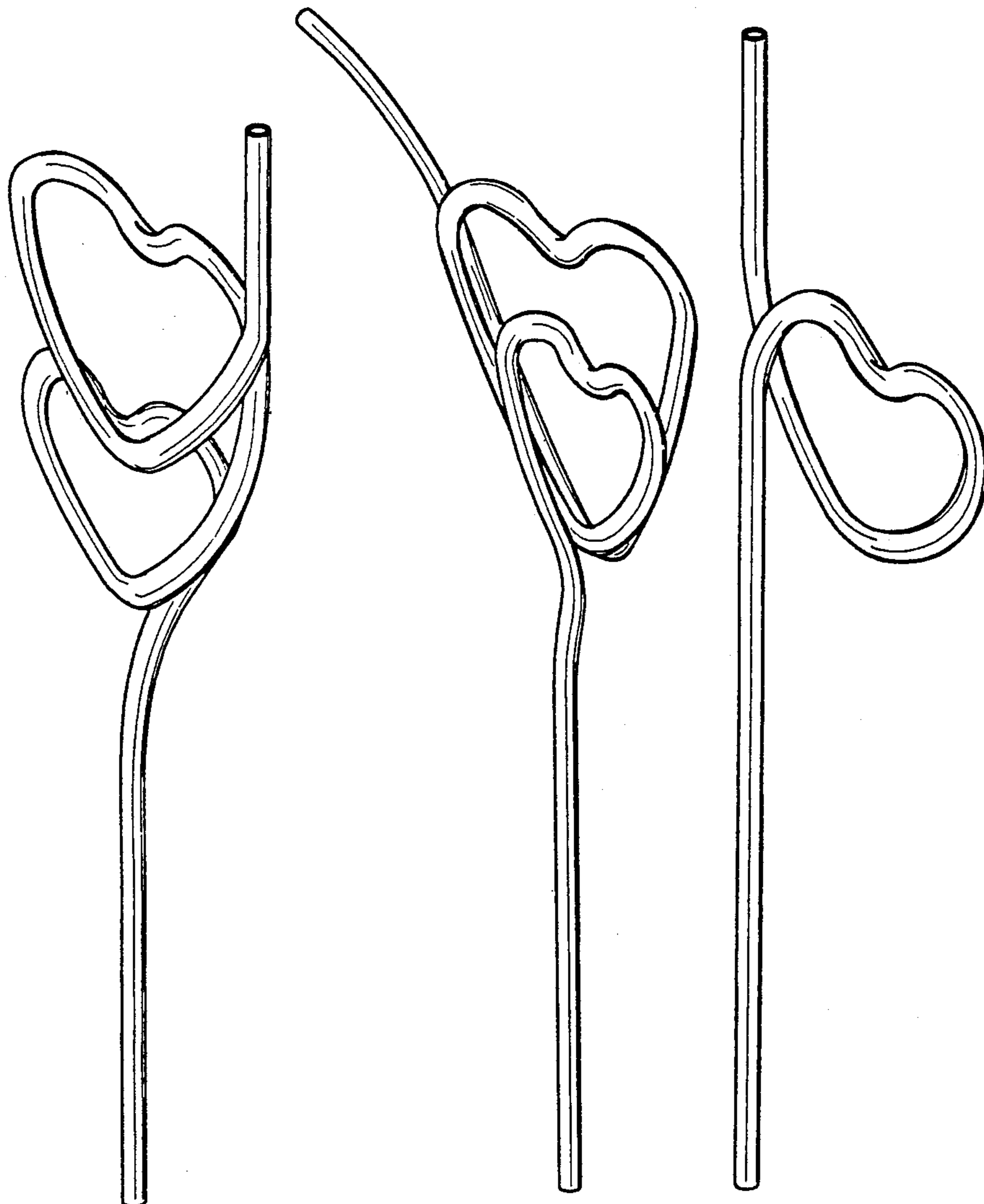

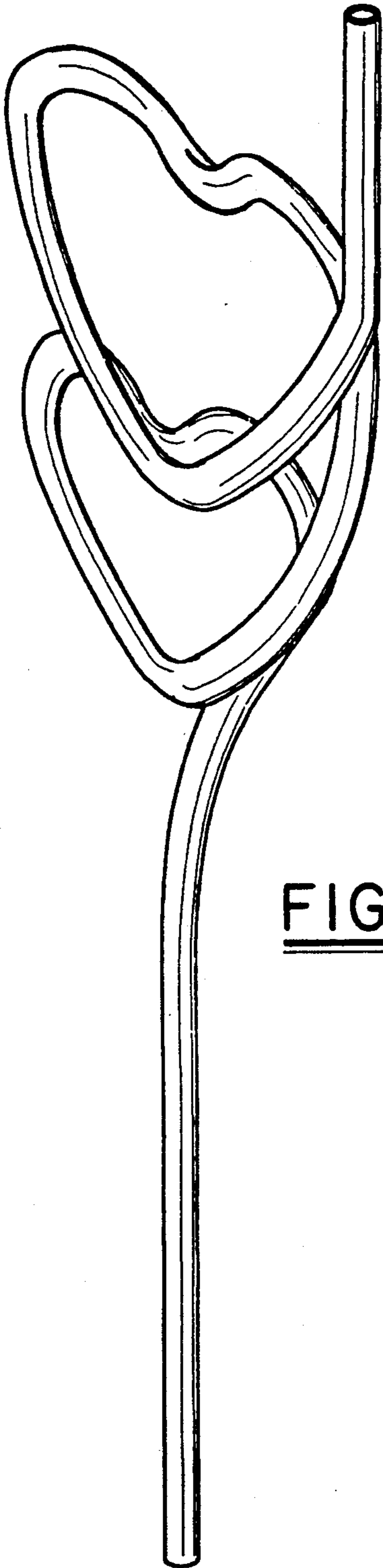

FIG.-1

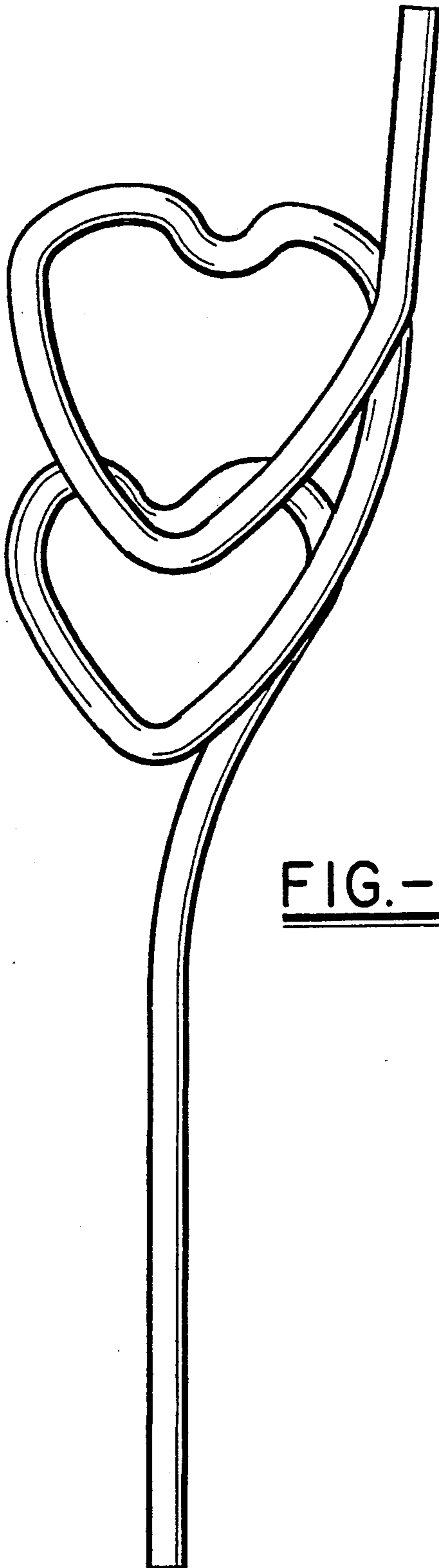

FIG.-2

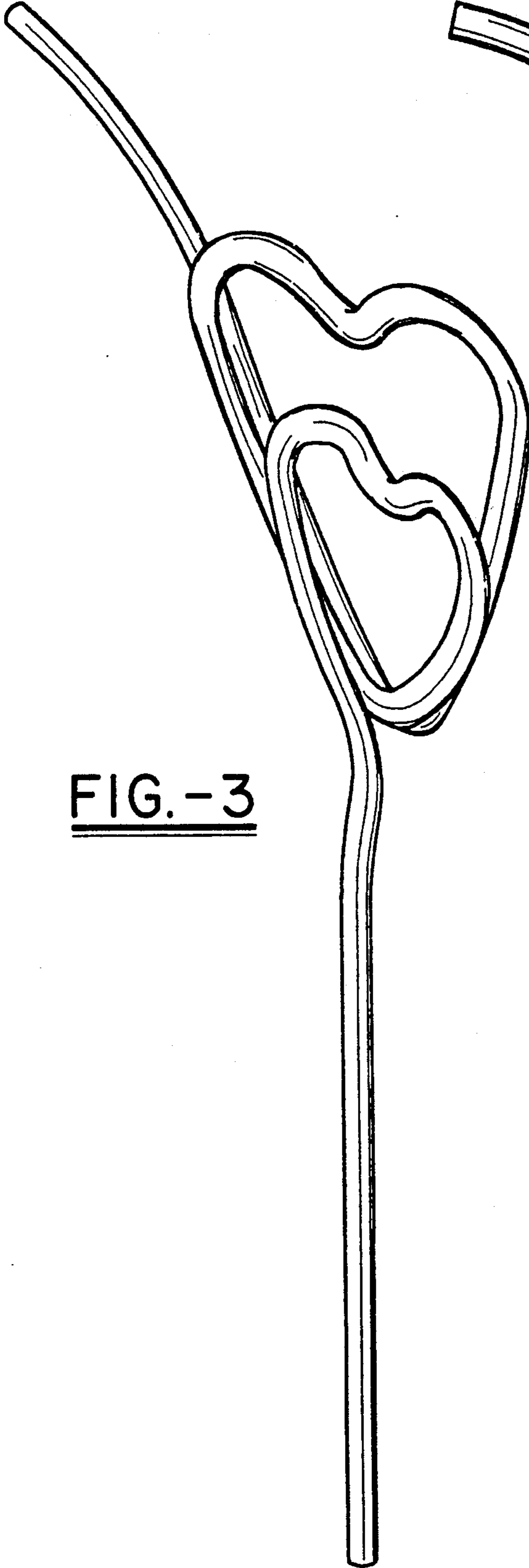

FIG.-3

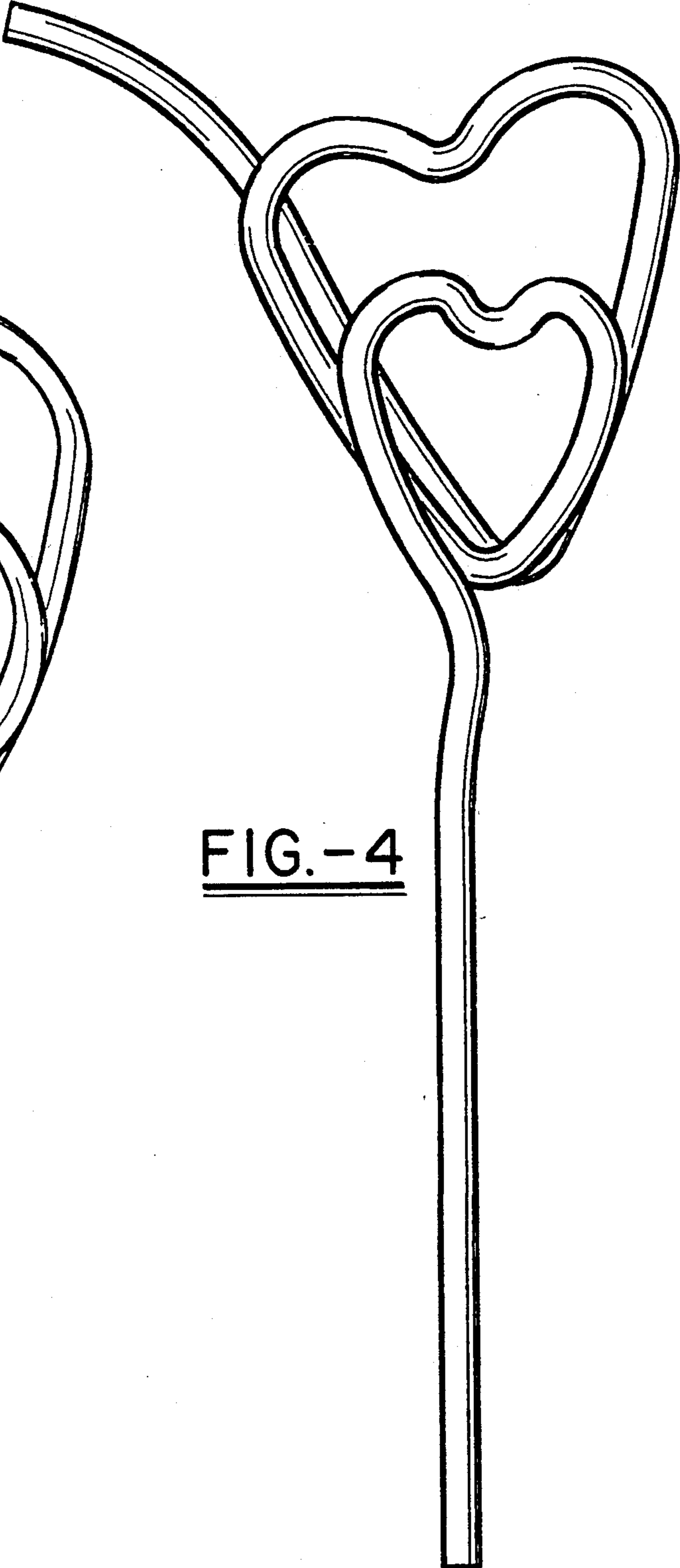

FIG.-4

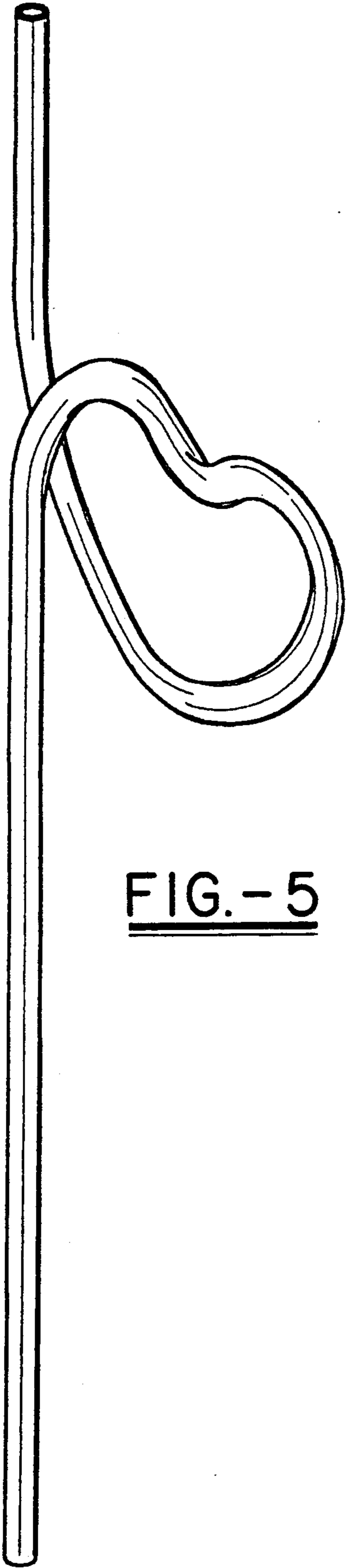

FIG. - 5

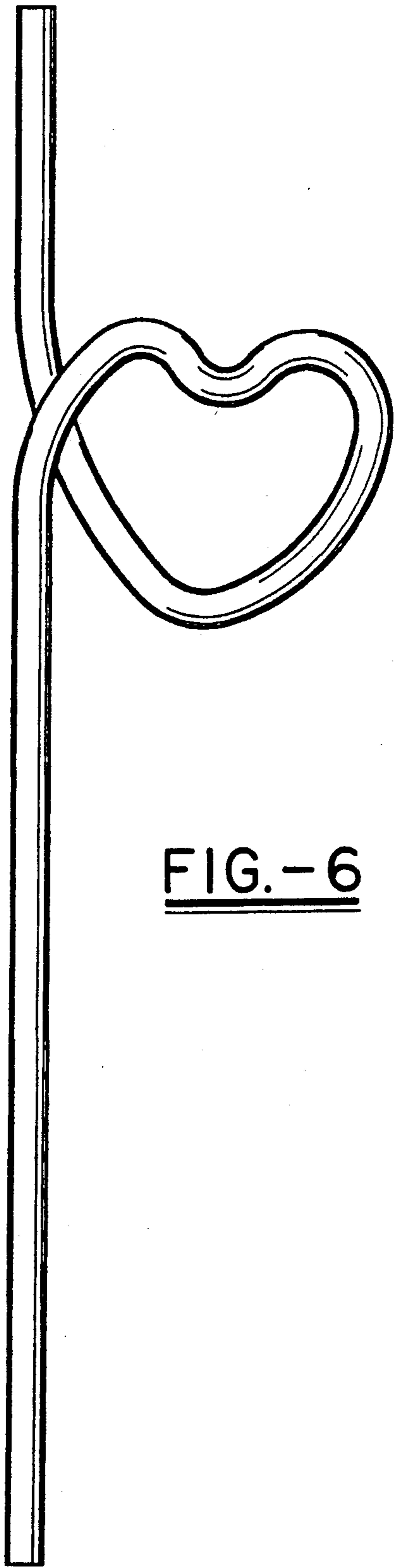

FIG. - 6