



US00D324773S

# United States Patent [19]

[11] Patent Number: **Des. 324,773**

Baruch

[45] Date of Patent: **\*\* Mar. 24, 1992**

[54] **HOLSTER**

4,858,800	8/1989	Holzclaw, Jr. et al. ....	224/253 X
4,896,805	1/1990	Klaczak et al. ....	224/236
4,953,767	9/1990	Bennett .....	224/104 X

[76] Inventor: **Alan Baruch**, 820 Kings Ct., Apt. H, Punta Gorda, Fla. 33950

*Primary Examiner*—A. Hugo Word  
*Assistant Examiner*—M. N. Pandozzi  
*Attorney, Agent, or Firm*—Blum Kaplan

[\*\*] Term: **14 Years**

[21] Appl. No.: **473,192**

[57] **CLAIM**

[22] Filed: **Jan. 31, 1990**

The ornamental design for a holster, as shown and described.

[52] U.S. Cl. .... **D3/101; D3/100; D3/102**

[58] Field of Search ..... **D3/100-106, D3/30.1, 99, 60; D8/71; 224/904, 253, 226, 193, 182, 140, 228, 911, 912, 252, 235, 236, 191, 231, 227, 240, 251, 918, 224, 229, 269, 222, 232; 206/305; 383/84, 86, 40**

**DESCRIPTION**

FIG. 1 is a perspective view of a holster showing my new design;  
FIG. 2 is a top plan view thereof;  
FIG. 3 is a right side elevational view thereof;  
FIG. 4 is a rear elevational view thereof;  
FIG. 5 is a left side elevational view thereof; and,  
FIG. 6 is a bottom plan view thereof.

[56] **References Cited**

**U.S. PATENT DOCUMENTS**

D. 240,572	7/1976	Worsham .....	D3/105
3,091,378	5/1963	O'Dwyer .....	224/252
4,573,573	3/1986	Favaro .....	206/305
4,828,154	5/1989	Clifton, Jr. ....	224/226 X

The broken line showing of a portion of a belt and a gun in FIG. 1 is for illustrative purposes only and forms no part of the claimed design.

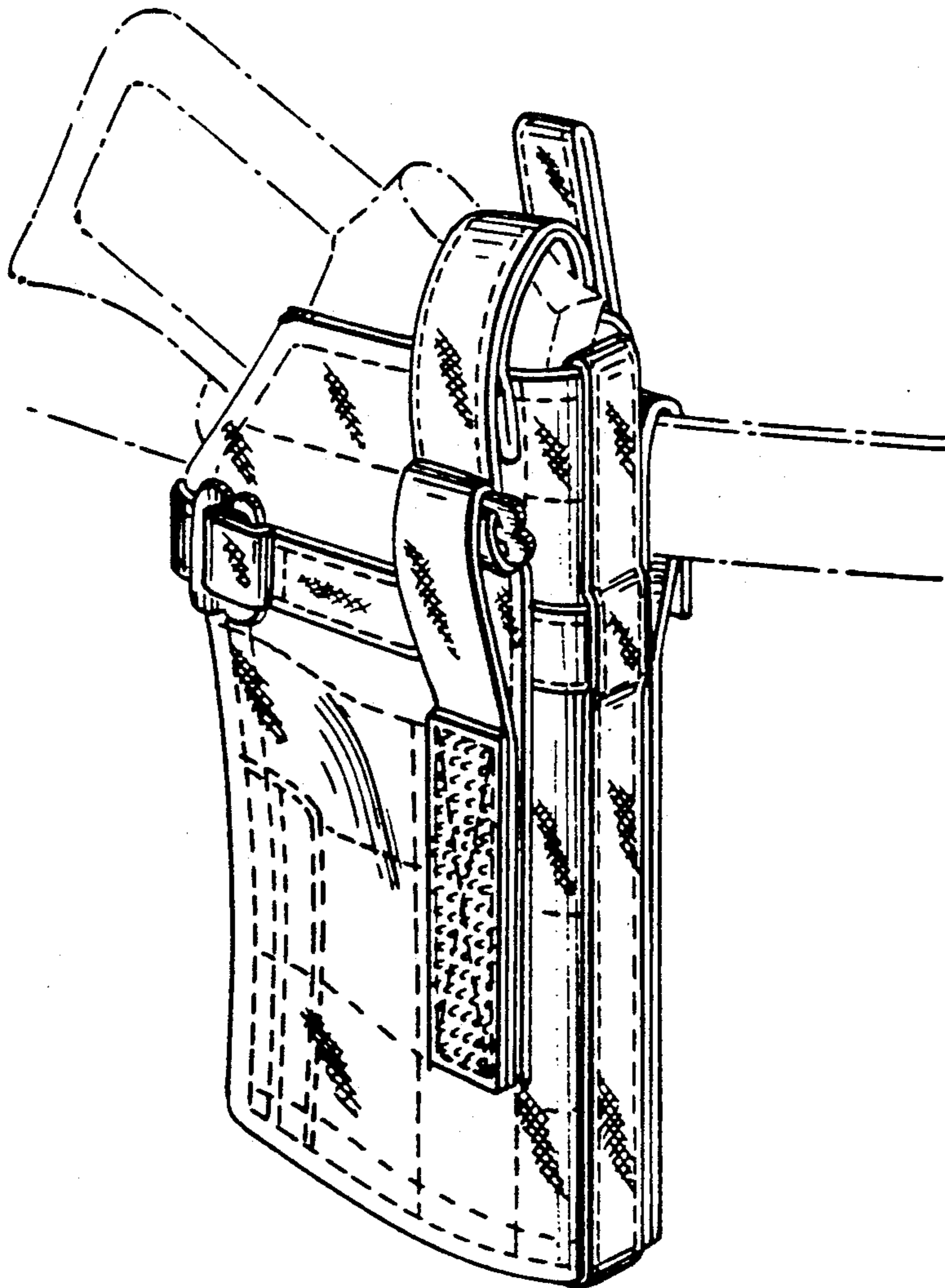

FIG. 1

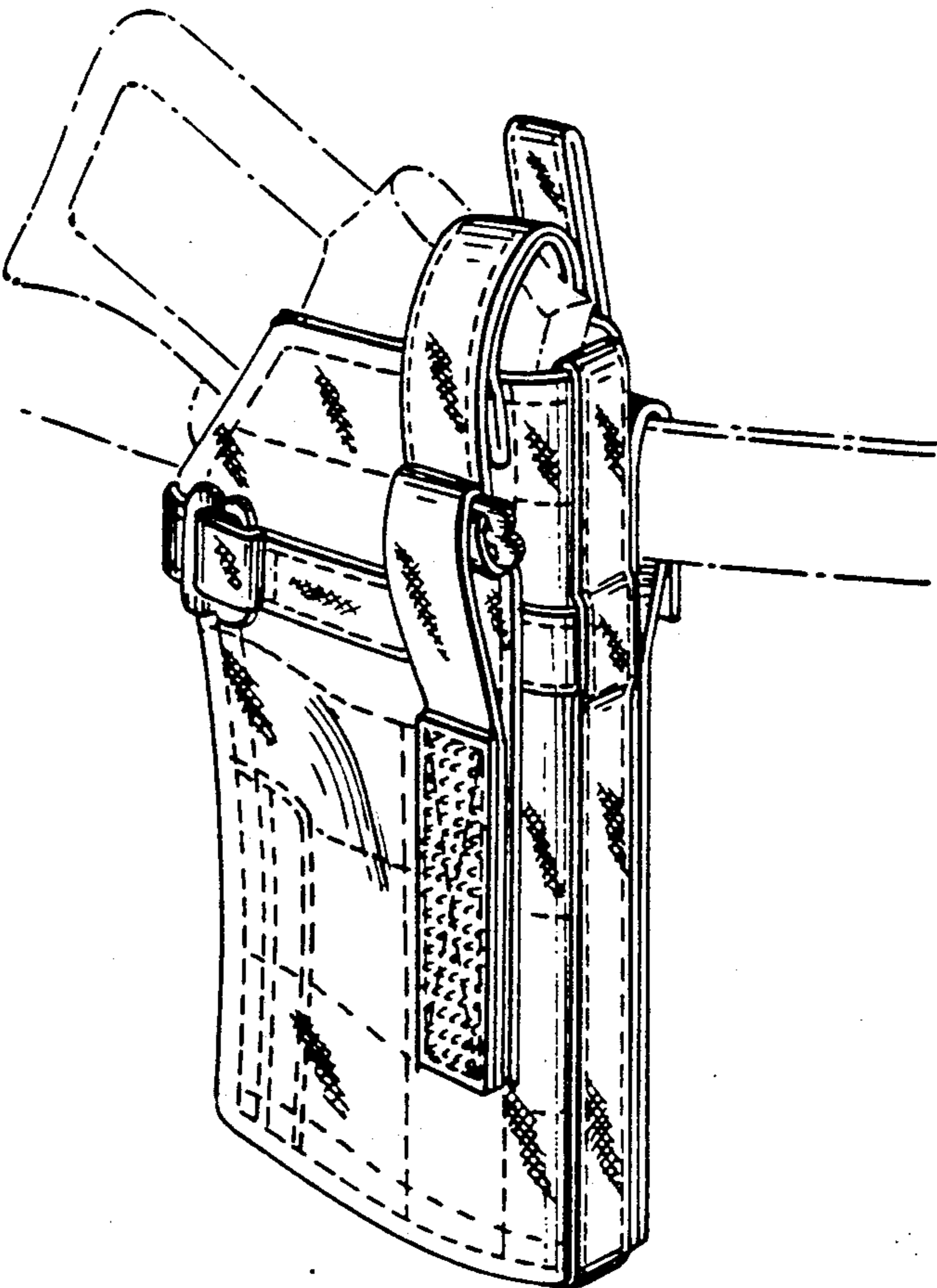

FIG. 2

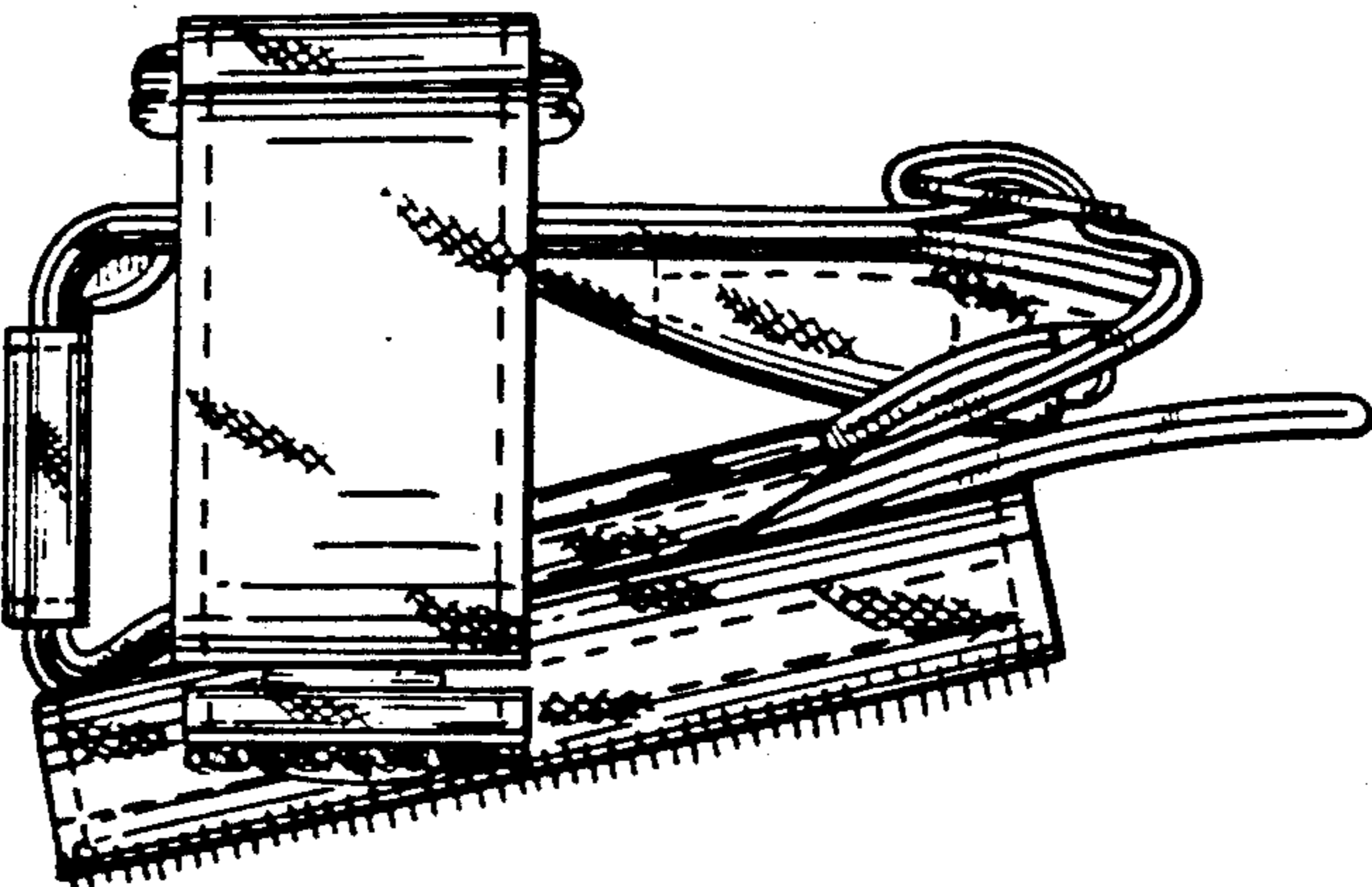

FIG. 3

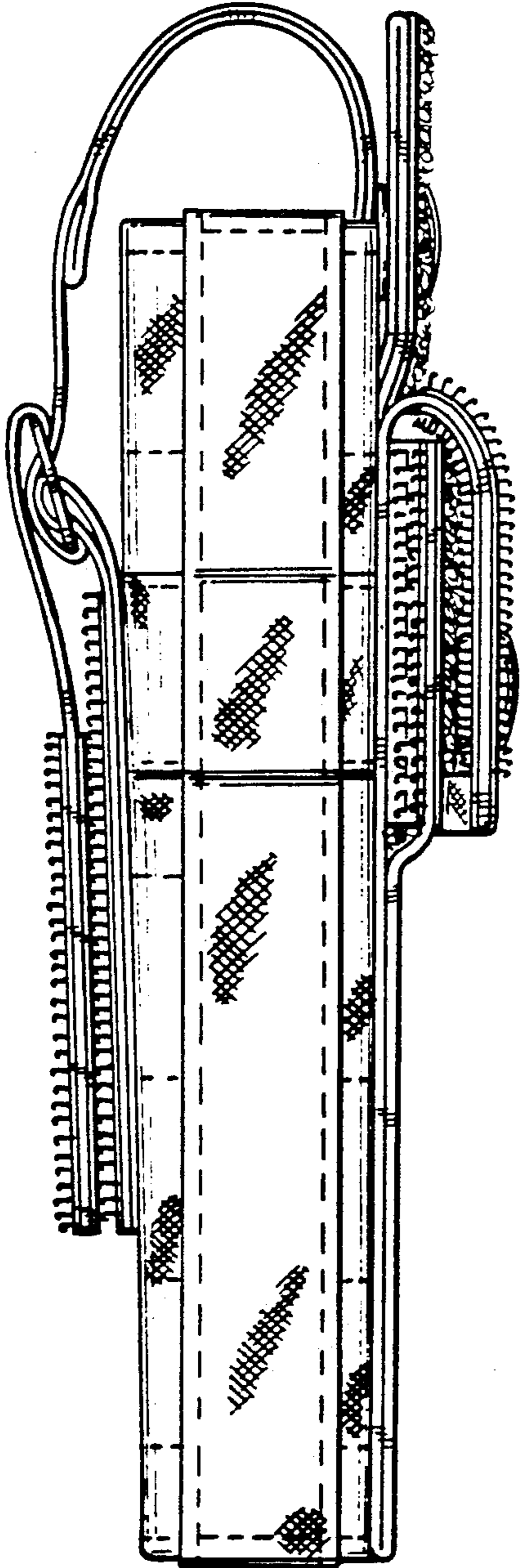
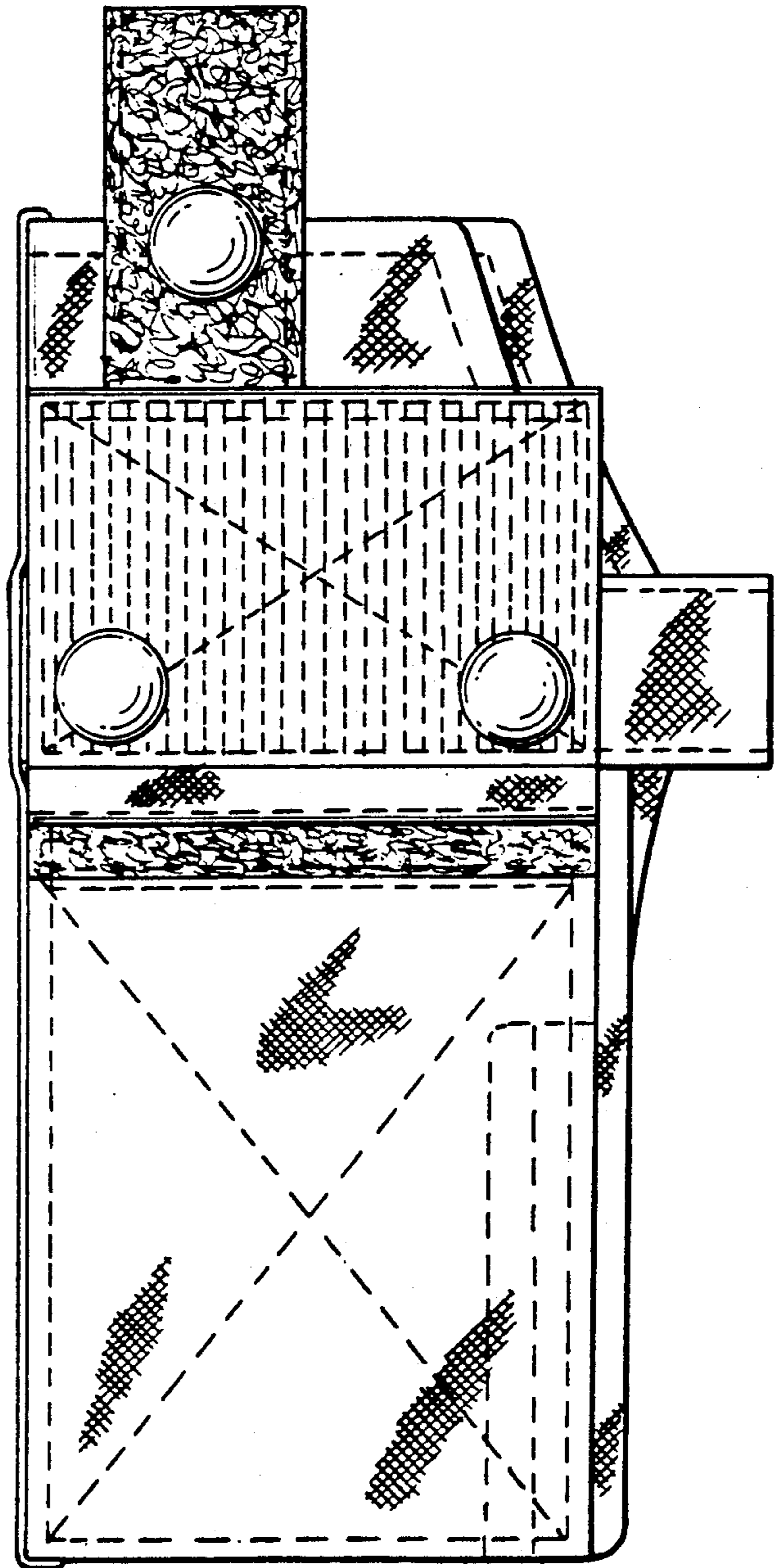
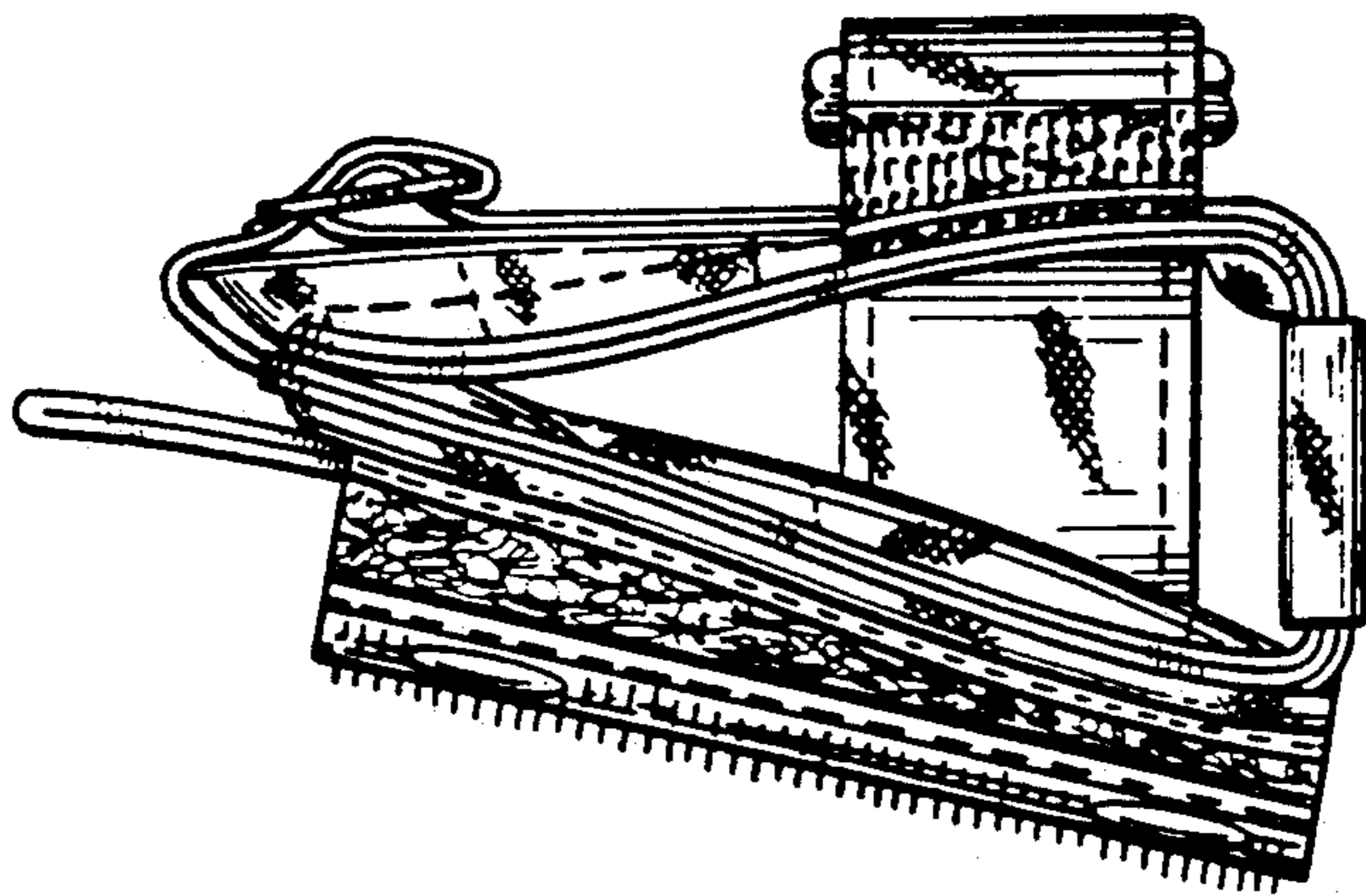
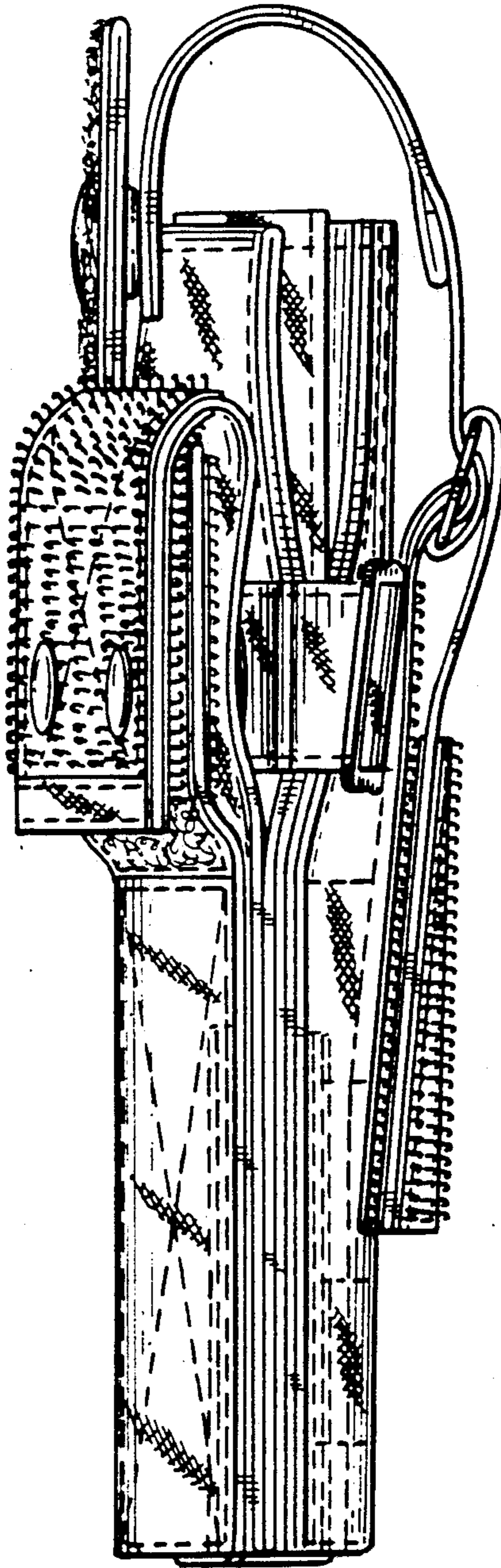

FIG. 4



**FIG. 5**



**FIG. 6**