



US00D324713S

# United States Patent [19] Rubin

[11] Patent Number: **Des. 324,713**

[45] Date of Patent: **\*\* Mar. 17, 1992**

## [54] LONG BLADE ROLLER SKATE

[75] Inventor: **Bruce J. Rubin**, Minneapolis, Minn.

[73] Assignee: **Rollerblade, Inc.**, Minnetonka, Minn.

[\*\*] Term: **14 Years**

[21] Appl. No.: **440,286**

[22] Filed: **Nov. 22, 1989**

[52] U.S. Cl. .... **D21/226**

[58] Field of Search ..... **D21/224, 225, 226;**  
**280/11.1 R, 11.19, 11.2, 11.3, 11.22**

## [56] References Cited

### U.S. PATENT DOCUMENTS

D. 238,286	12/1975	Ochi .....	D21/226
D. 264,612	5/1982	Szegi .....	D21/226
D. 301,908	6/1989	Olson et al. ....	D21/226
864,333	8/1907	Pilz .	
2,048,916	7/1936	Bentzlin .	
2,220,557	11/1940	User .	
2,644,692	7/1953	Kahlert .	
3,229,989	1/1966	Papangelis .....	D21/226
3,287,023	11/1966	Ware .	
3,880,441	4/1975	Silver .	
3,900,203	8/1975	Kikulowicz .	
4,088,335	5/1978	Norton et al. .	
4,108,450	8/1978	Cote .	
4,273,345	6/1981	Ben-Dor .	
4,351,537	9/1982	Seidel .	
4,392,659	7/1983	Yoshimoto .	
4,418,929	12/1983	Gray .	
4,492,385	1/1985	Olson .	
4,711,458	12/1987	Shim .	

### FOREIGN PATENT DOCUMENTS

8104249	9/1981	Netherlands .
WO89/00046	6/1989	PCT Int'l Appl. .
1402028	8/1975	United Kingdom .

## OTHER PUBLICATIONS

North American Sports Training Corporation 1986-87 catalog, ©1986.

Rollerblade "get in-line" 1987-88 catalog, ©1987.

Rollerblade 1988-89 catalog, ©1988.

Rollerblade Spring '89 catalog, ©1989.

Rollerblade pink shirt catalog, ©1989.

Rollerblade seashore catalog, ©1989.

Rollerblade "Bladegear" 1989-90 catalog, ©1989.

Rollerblade "Skates+" 1989-90 catalog, ©1989.

Rollerblade "Perfect Gift for Anybody" fold-out brochure, Distributed . . . 8/8/89.

*Primary Examiner*—Charles A. Rademaker

*Attorney, Agent, or Firm*—Moore & Hansen

## [57] CLAIM

The ornamental design for long blade roller skate, as shown and described.

## DESCRIPTION

FIG. 1 is a perspective view of a long blade roller skate showing my new design;

FIG. 2 is a side elevational view thereof, the side opposite being a mirror image;

FIG. 3 is a top plan view thereof;

FIG. 4 is a bottom plan view thereof;

FIG. 5 is a front elevational view thereof;

FIG. 6 is a rear elevational view thereof;

FIG. 7 is a perspective view of a modified embodiment of the design shown in FIGS. 1 through 6;

FIG. 8 is a side elevational view of the embodiment of FIG. 7, the side opposite being a mirror image;

FIG. 9 is a top plan view of the embodiment of FIG. 7;

FIG. 10 is a bottom plan view of the embodiment of FIG. 7;

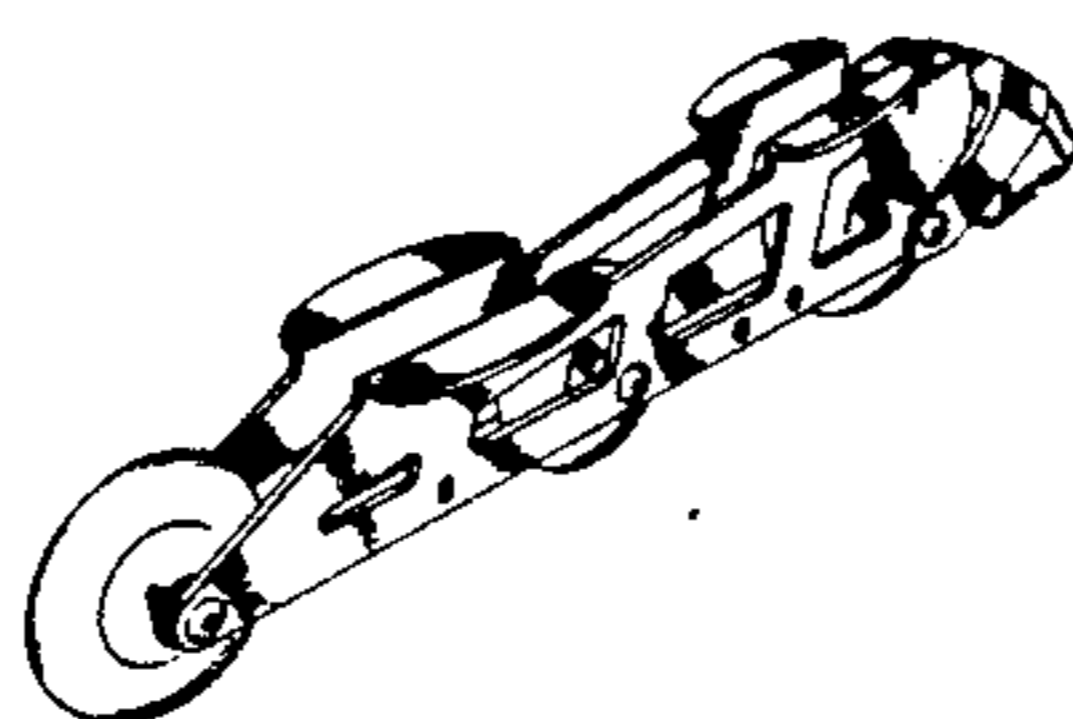
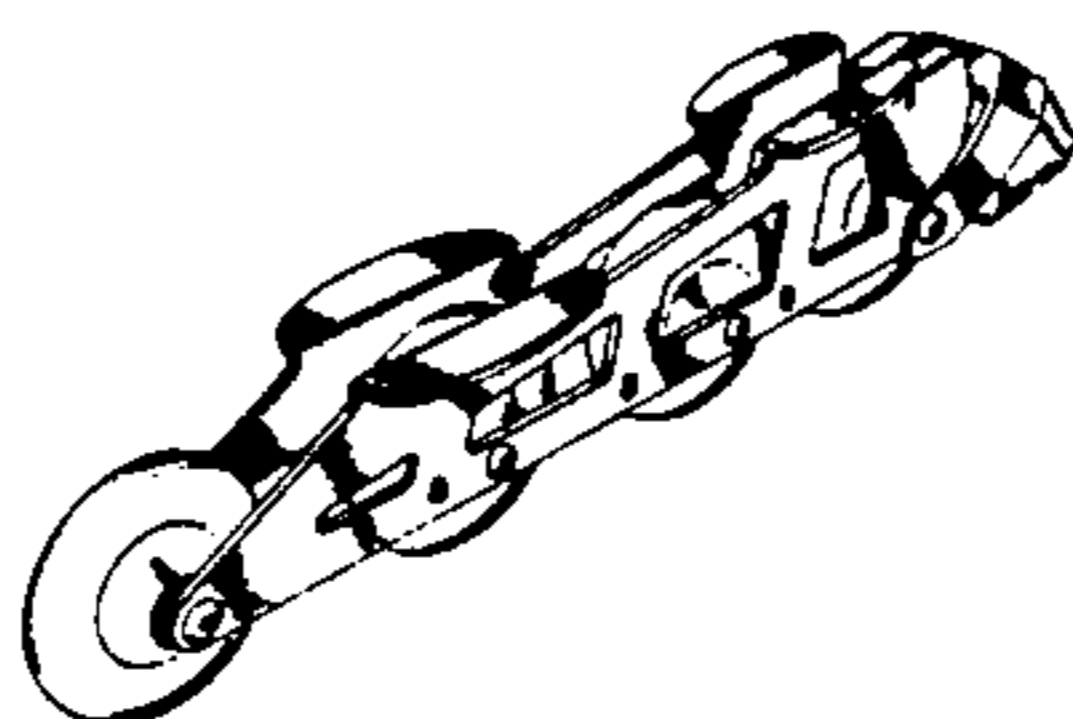
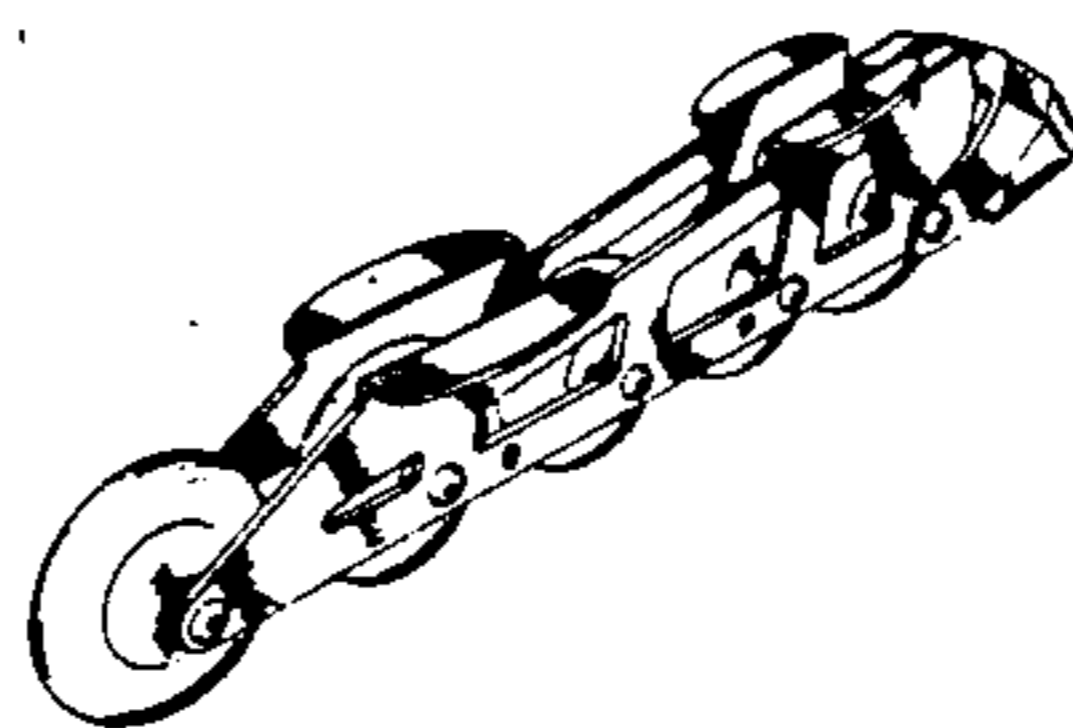
FIG. 11 is a perspective view of another embodiment of the design shown in FIGS. 1 through 6;

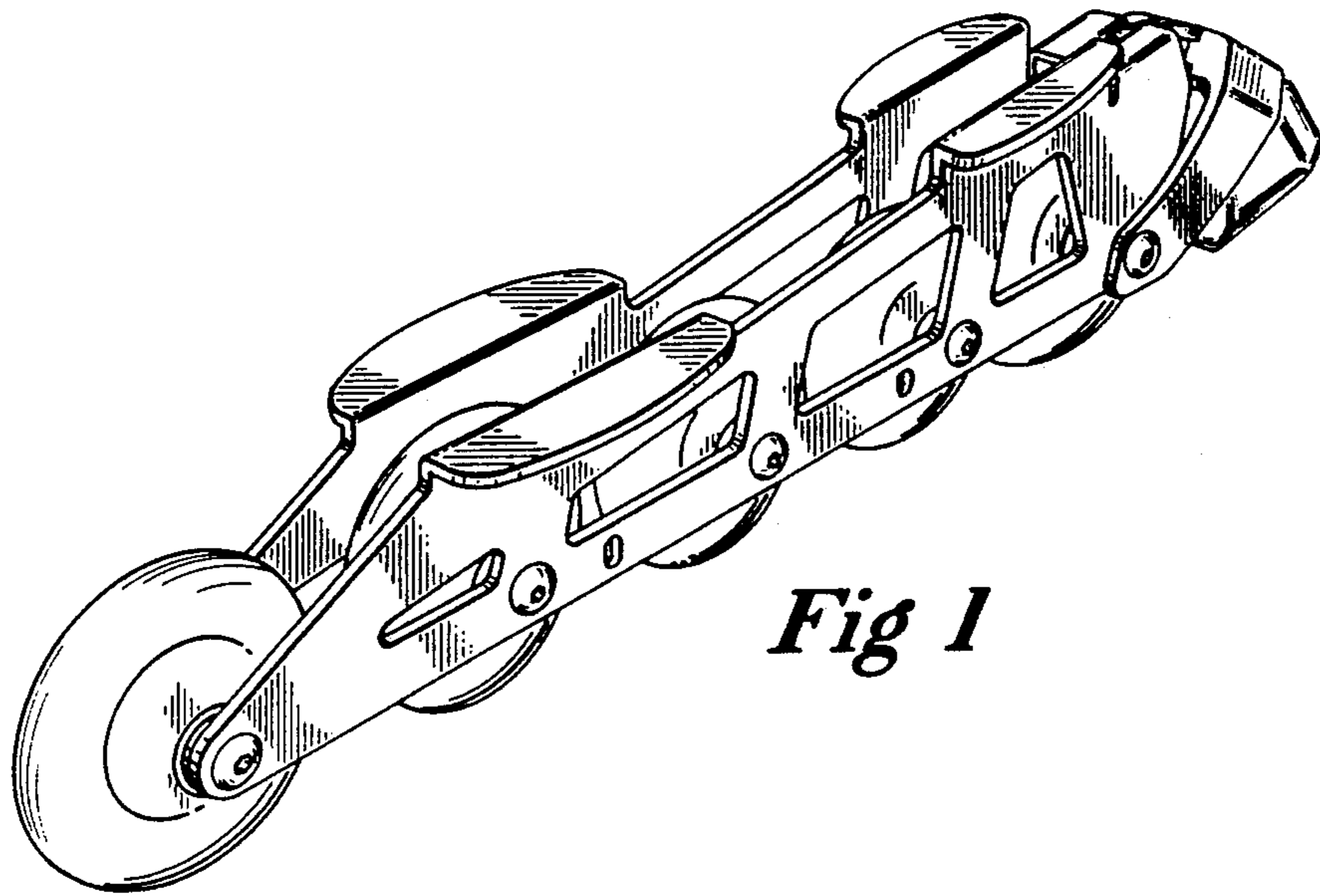
FIG. 12 is a side elevational view of the embodiment of FIG. 11, the side opposite being a mirror image;

FIG. 13 is a top plan view thereof; and

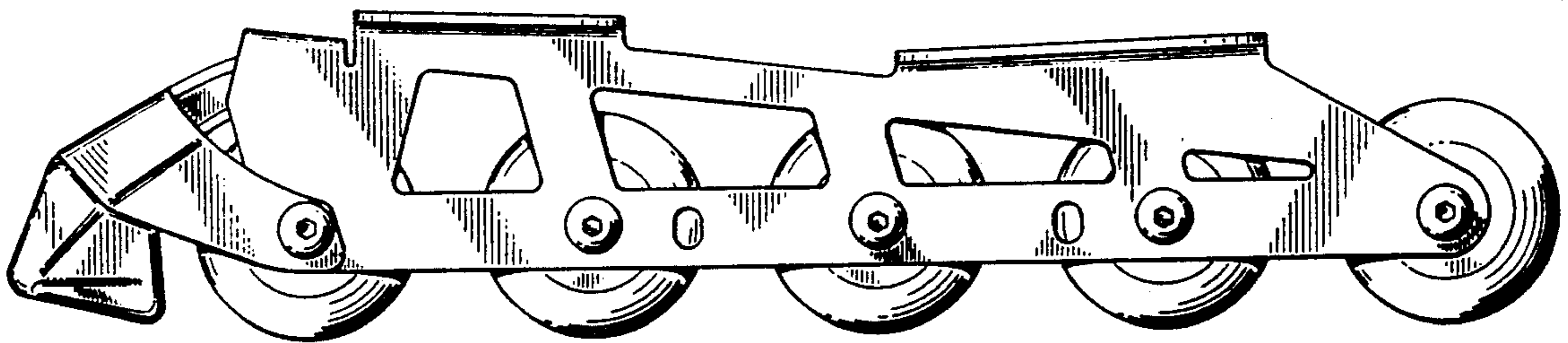
FIG. 14 is a bottom plan view thereof.

The unshown front and rear elevational views of the embodiments disclosed in FIGS. 7-14 are identical to those shown in FIGS. 5 and 6.

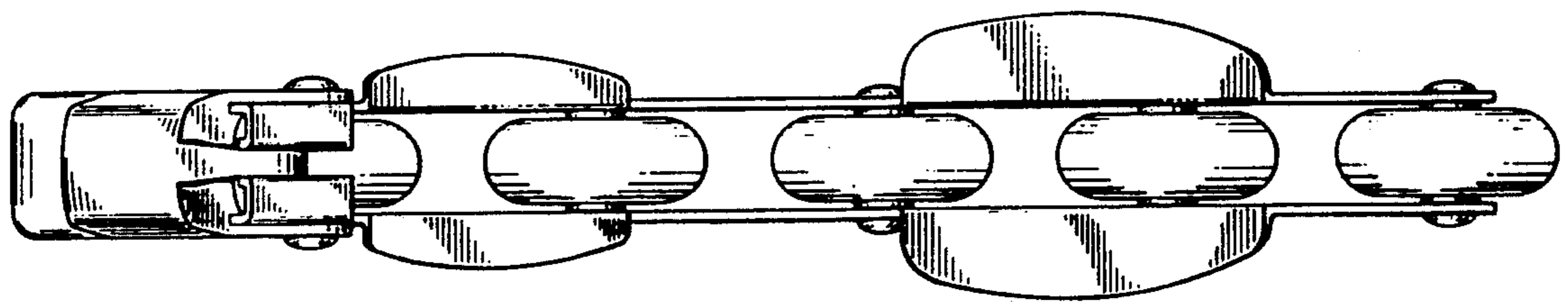




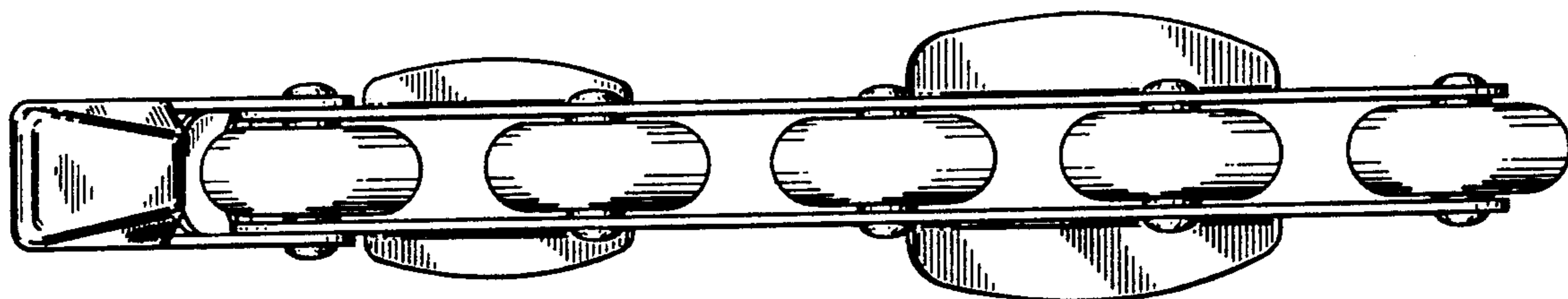
*Fig 1*



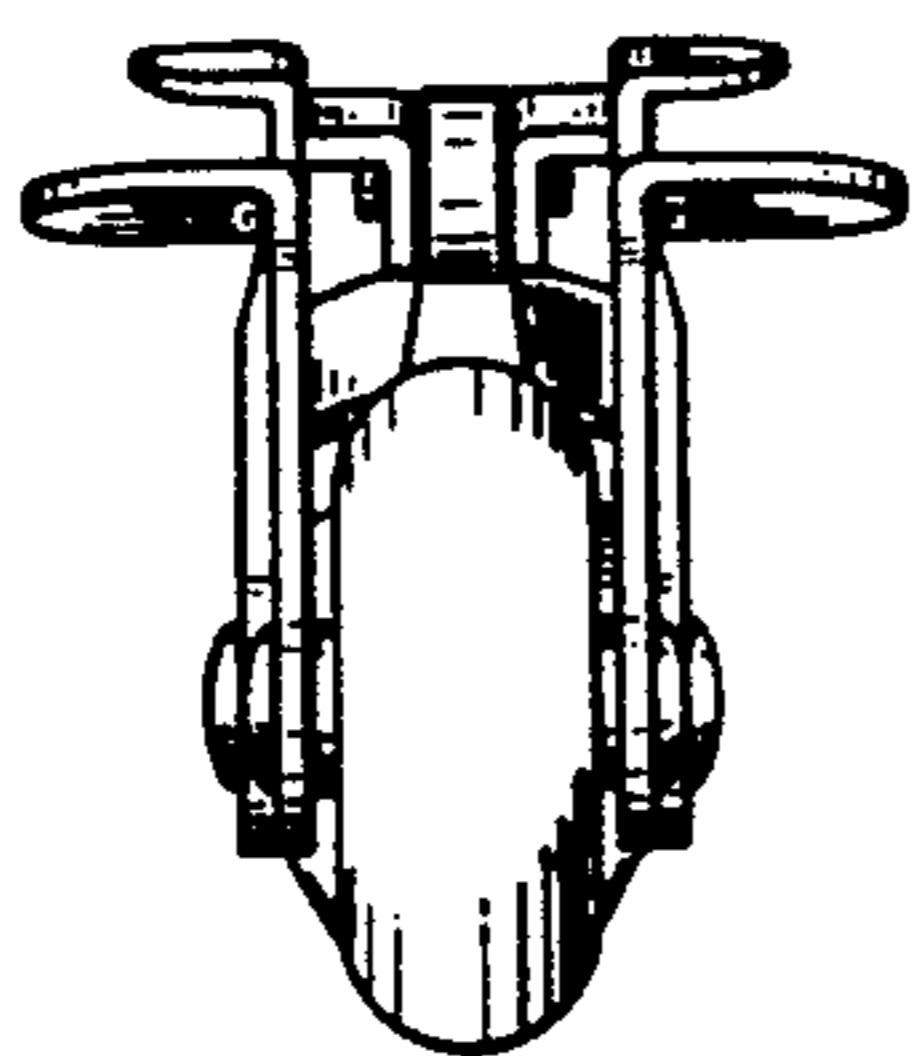
*Fig 2*



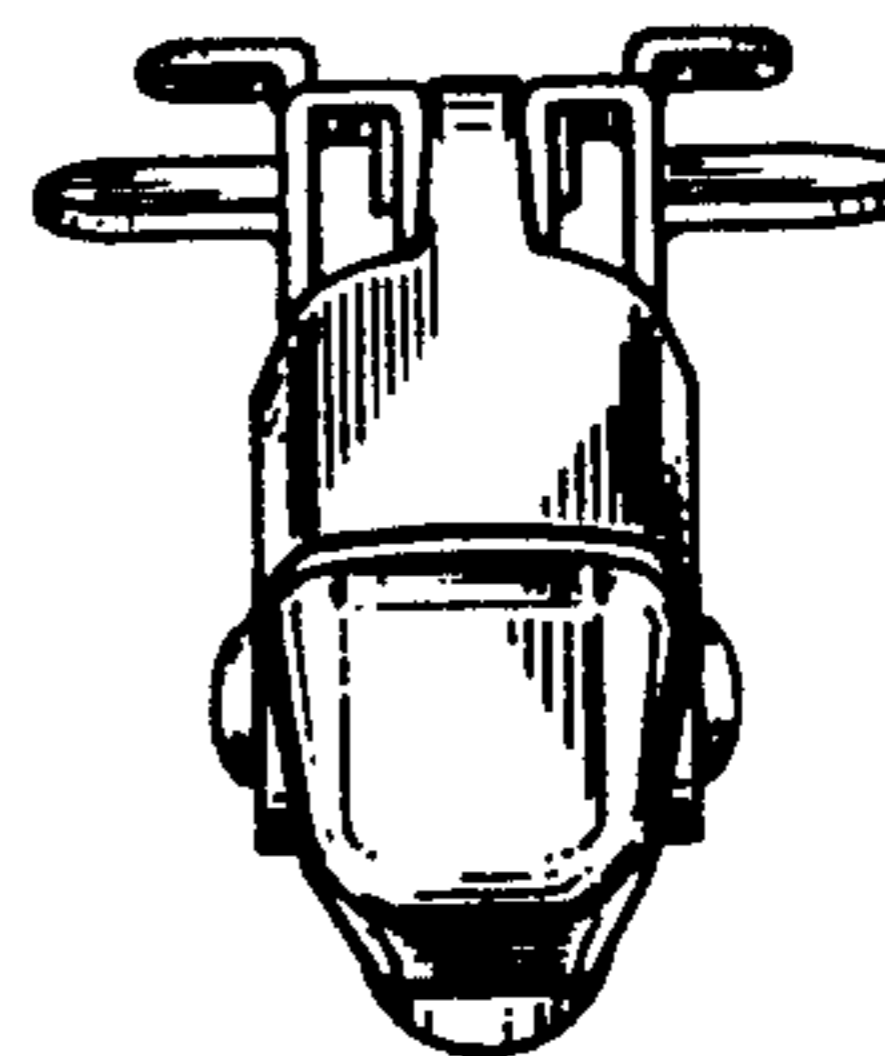
*Fig 3*



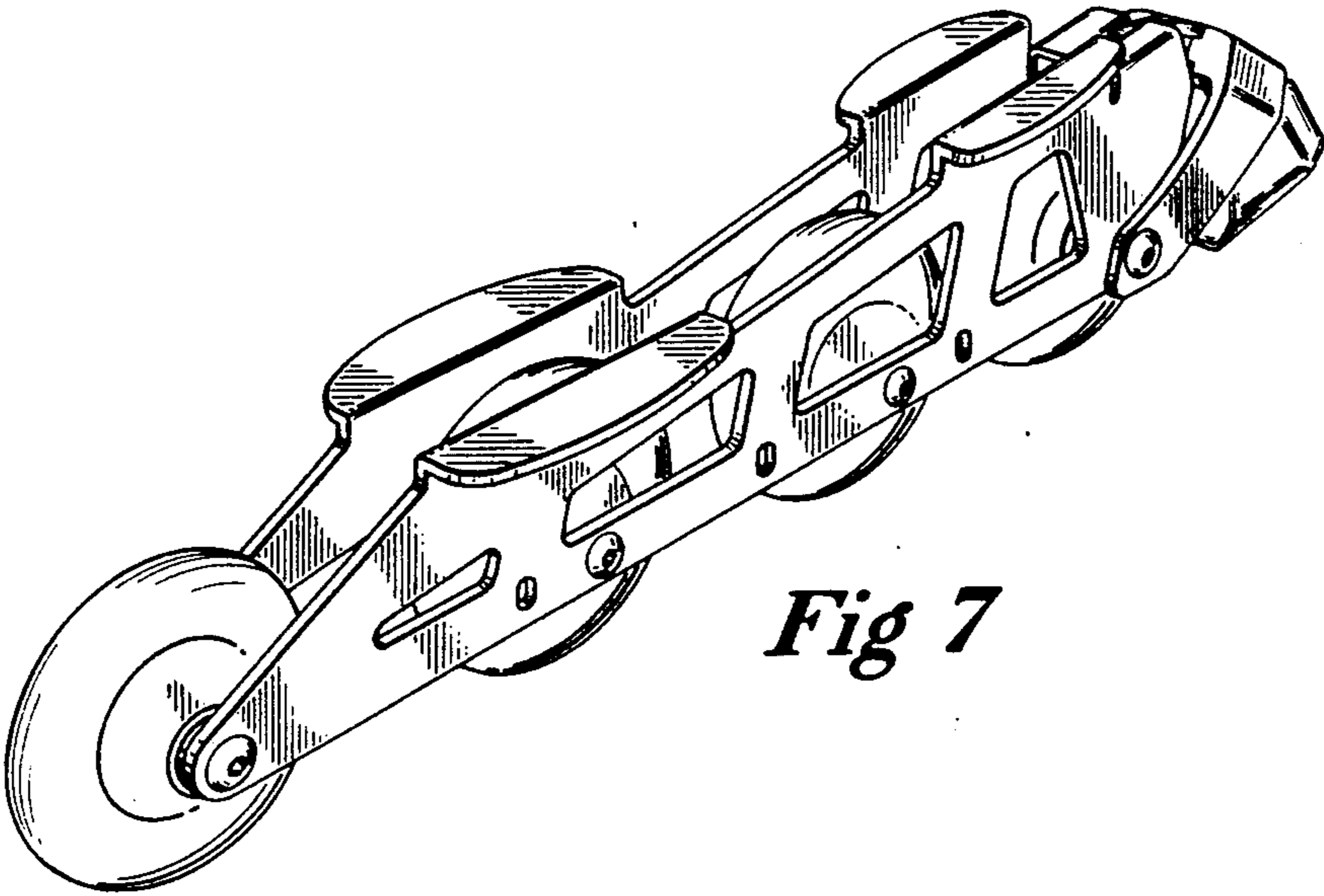
*Fig 4*



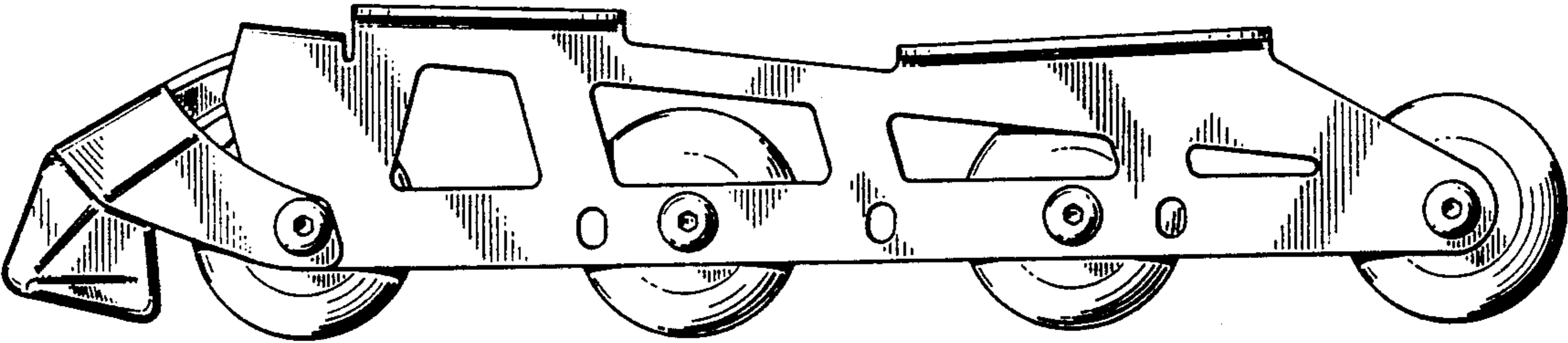
*Fig 5*



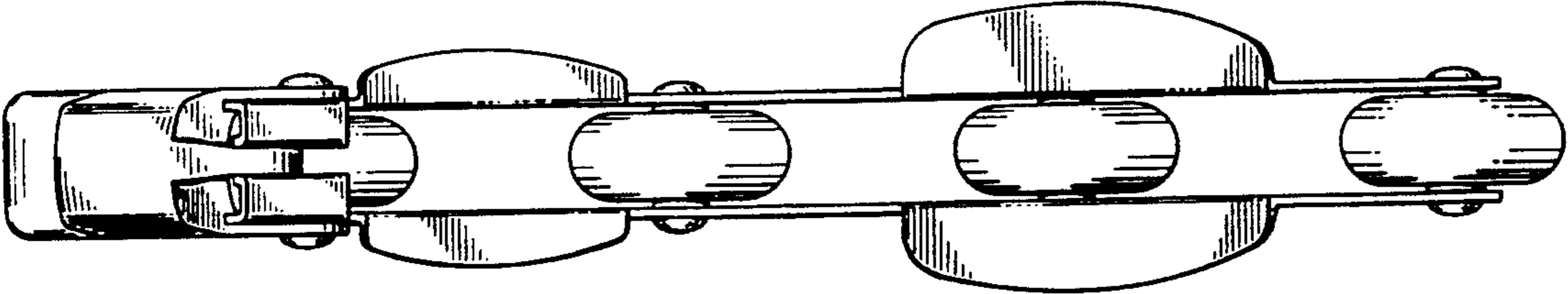
*Fig 6*



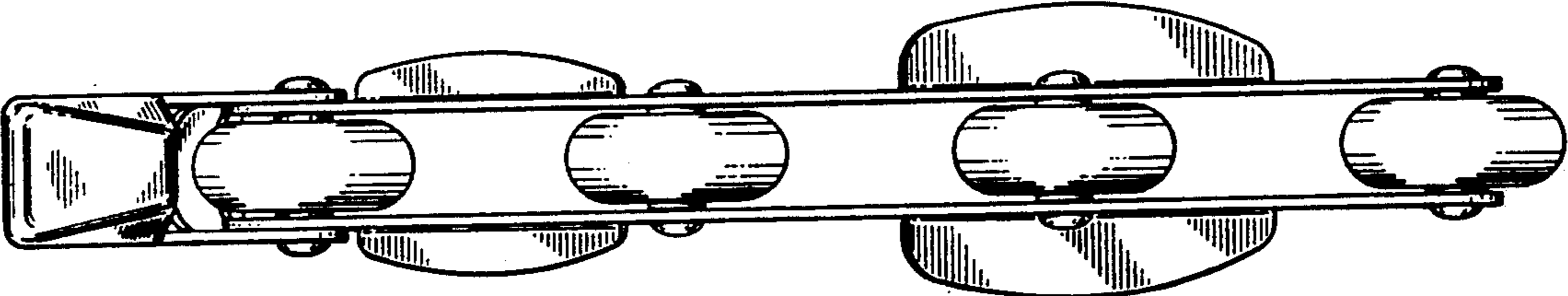
*Fig 7*



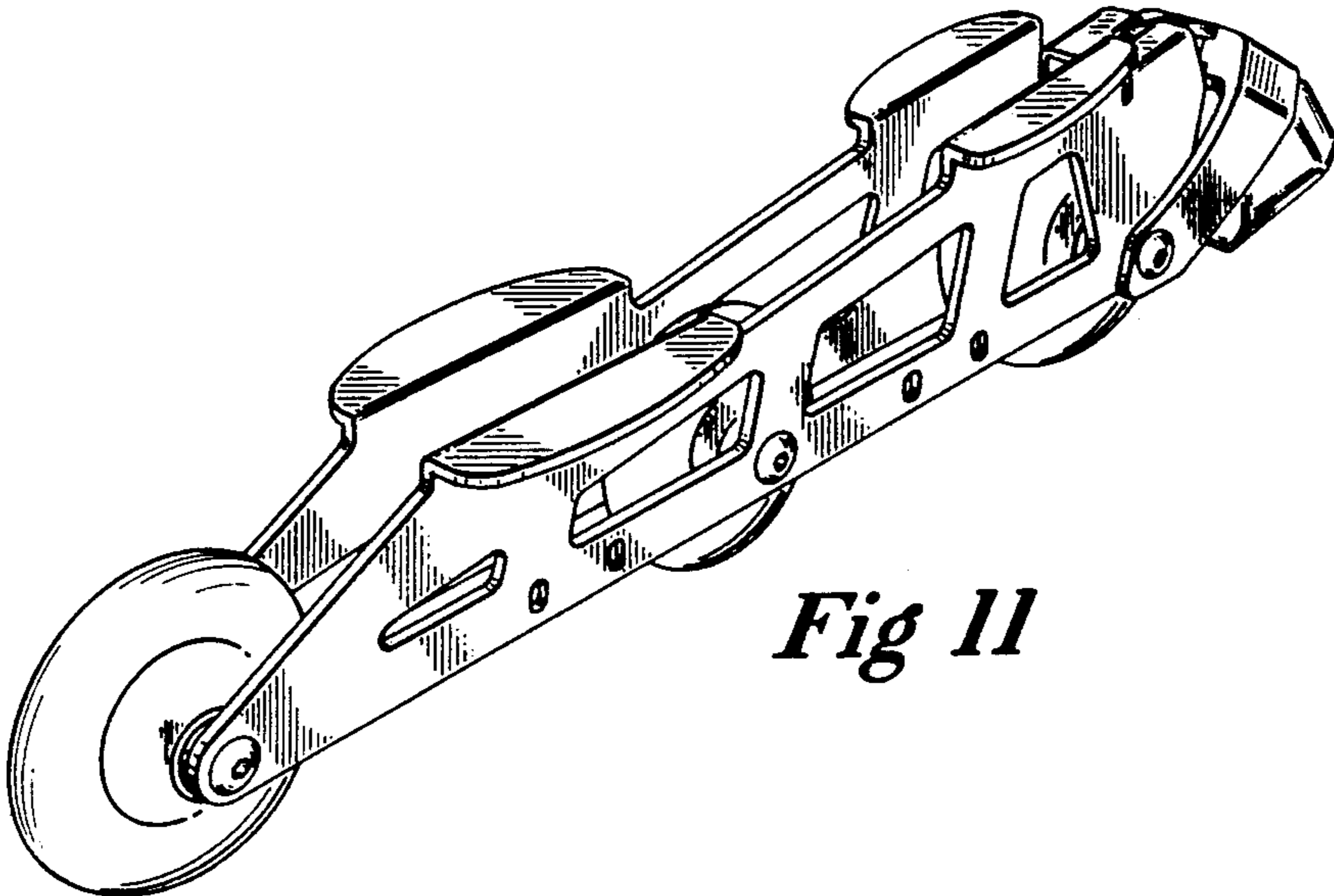
*Fig 8*



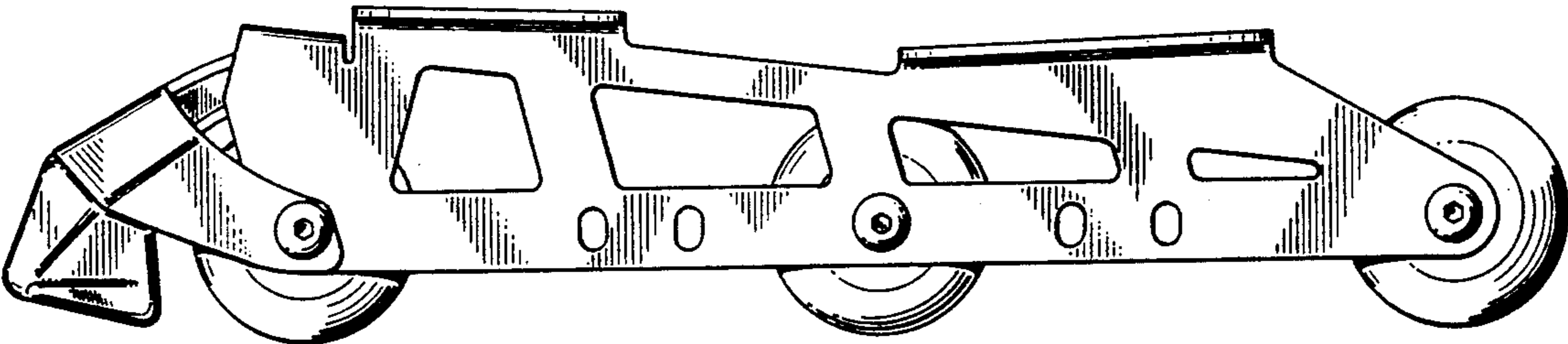
*Fig 9*



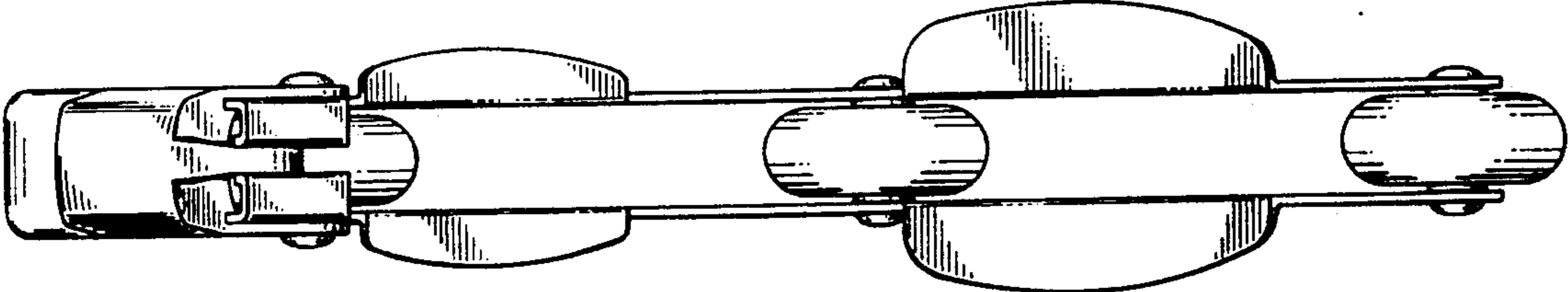
*Fig 10*



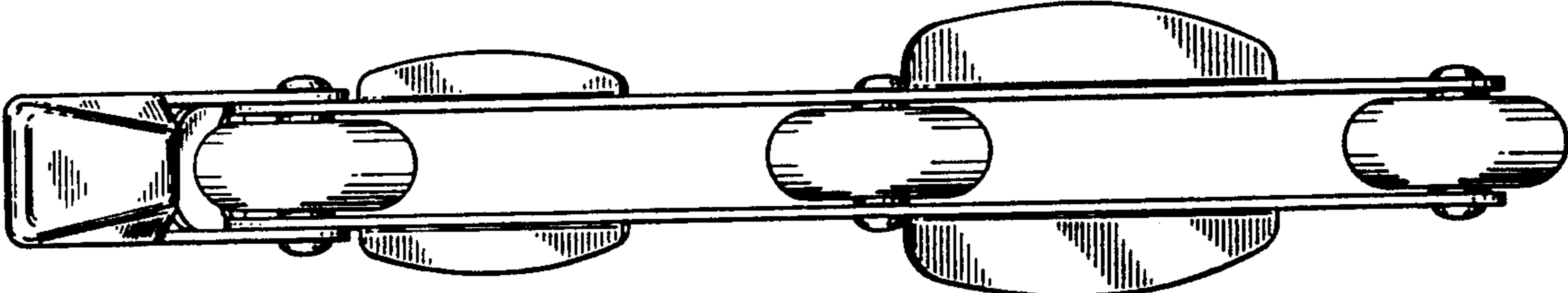
*Fig 11*



*Fig 12*



*Fig 13*



*Fig 14*