



US00D324592S

United States Patent [19]

[11] Patent Number: Des. 324,592

Klingspor et al.

[45] Date of Patent: ** Mar. 10, 1992

[54] VACUUM CLEANER

[75] Inventors: Christian S. Klingspor, Djursholm;
Carl-Gustaf Frisell, Stockholm, both
of Sweden

[73] Assignee: Aktiebolaget Electrolux, Stockholm,
Sweden

[**] Term: 14 Years

[21] Appl. No.: 476,280

[22] Filed: Feb. 7, 1990

[30] Foreign Application Priority Data

Aug. 8, 1989 [SE] Sweden 89-1801

[52] U.S. Cl. D32/21

[58] Field of Search D32/23-24;
15/412, 327.1, 327.2, 327.6, 327.7, 347

[56] References Cited

U.S. PATENT DOCUMENTS

D. 290,896 7/1987 Kim D32/24

D. 296,944 7/1988 Yamamoto et al. D32/21
D. 311,613 10/1990 Kuriya D32/21
D. 311,614 10/1990 Hiyano et al. D32/21
D. 315,233 3/1991 Klingspor et al. D32/21

Primary Examiner—Louis S. Zarfes
Assistant Examiner—Ruth McInroy
Attorney, Agent, or Firm—Pearne, Gordon, McCoy &
Granger

[57] CLAIM

The ornamental design for a vacuum cleaner, as shown
and described.

DESCRIPTION

FIG. 1 is a front perspective view of a vacuum cleaner
showing our new design;
FIG. 2 is a rear perspective view thereof;
FIG. 3 is a top plan view thereof;
FIG. 4 is a bottom plan view thereof;
FIG. 5 is a front elevational view thereof;
FIG. 6 is a rear elevational view thereof;
FIG. 7 is a right side elevational view thereof; and
FIG. 8 is a left side elevational view thereof.

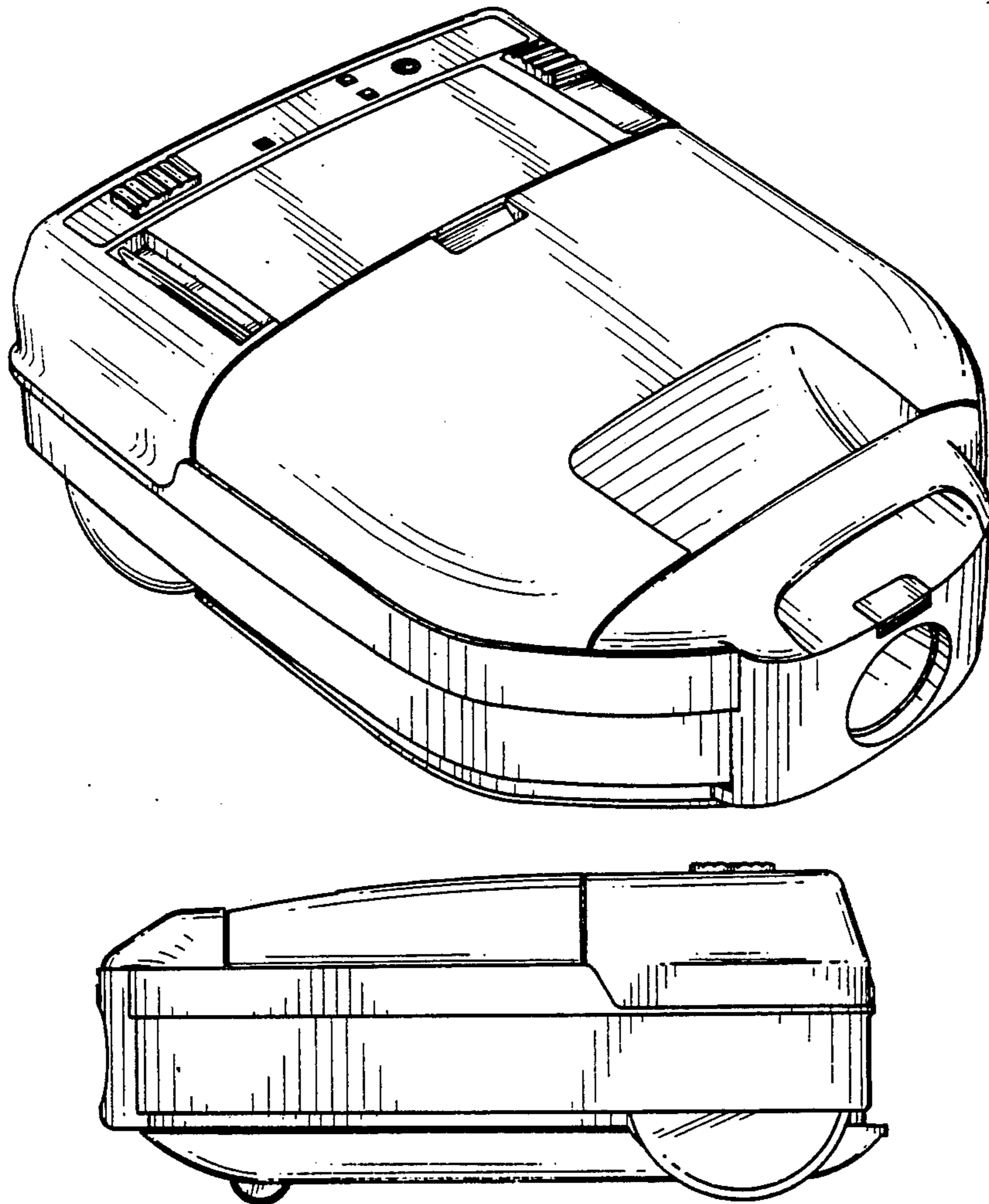

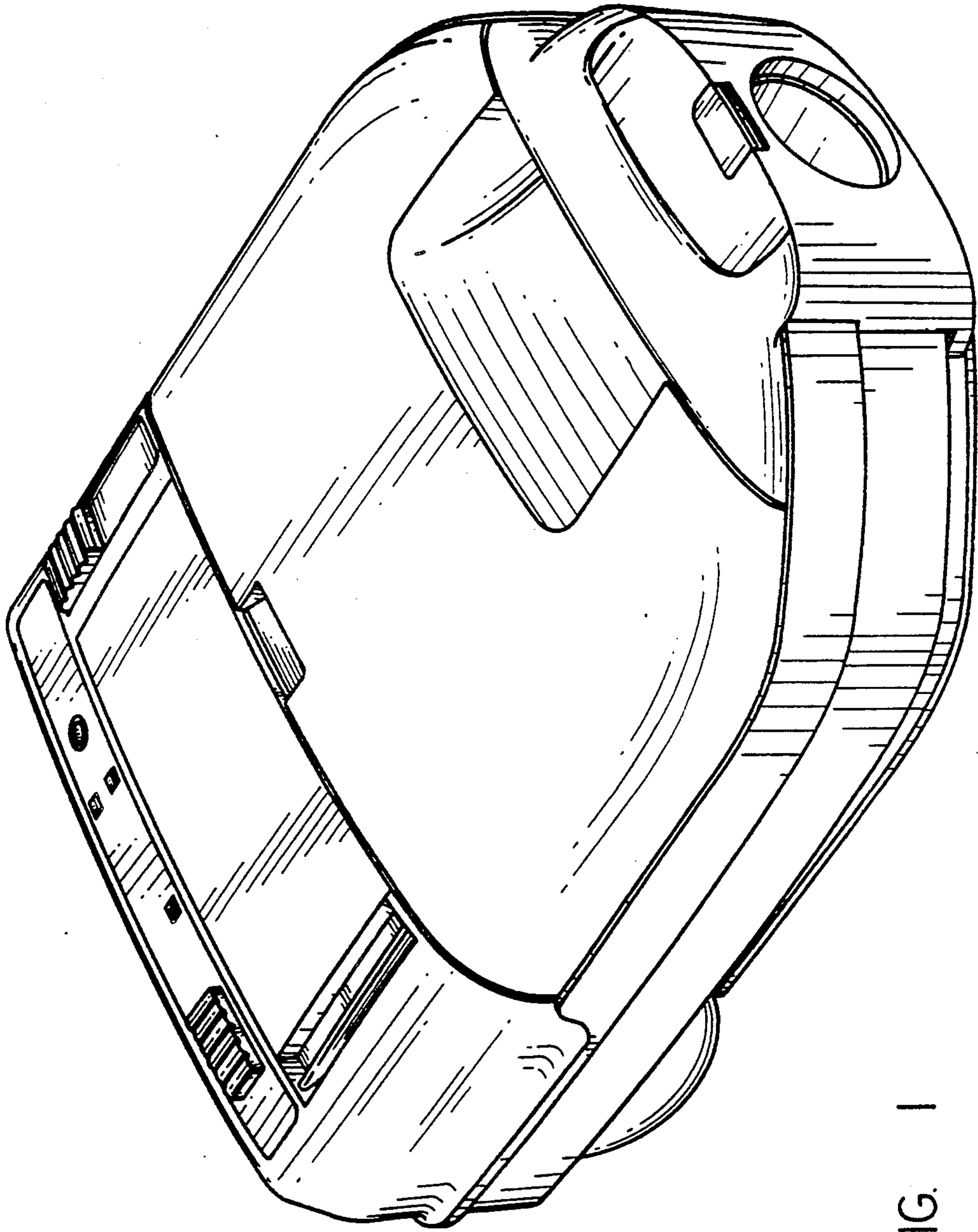

FIG. 1

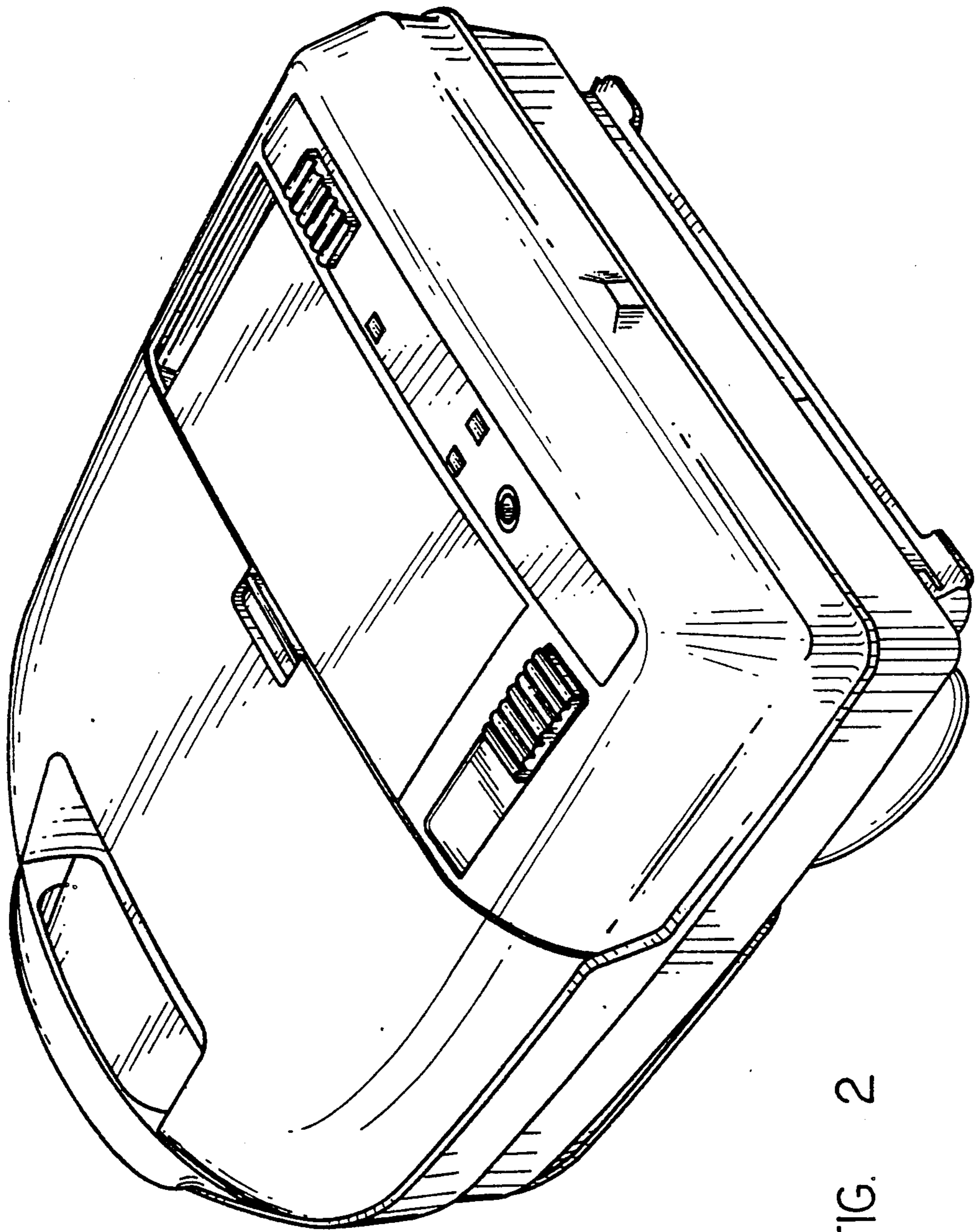

FIG. 2

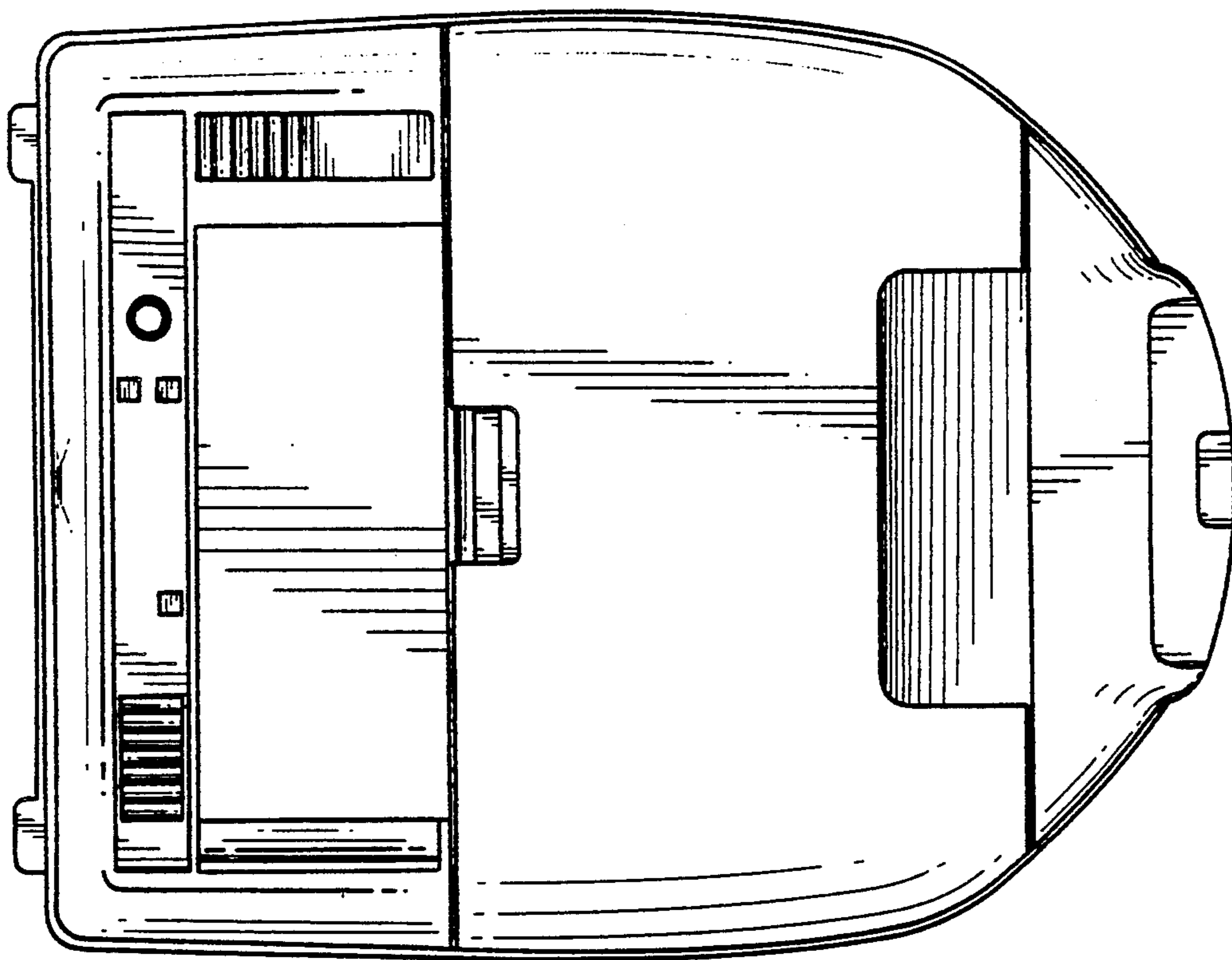

FIG. 3

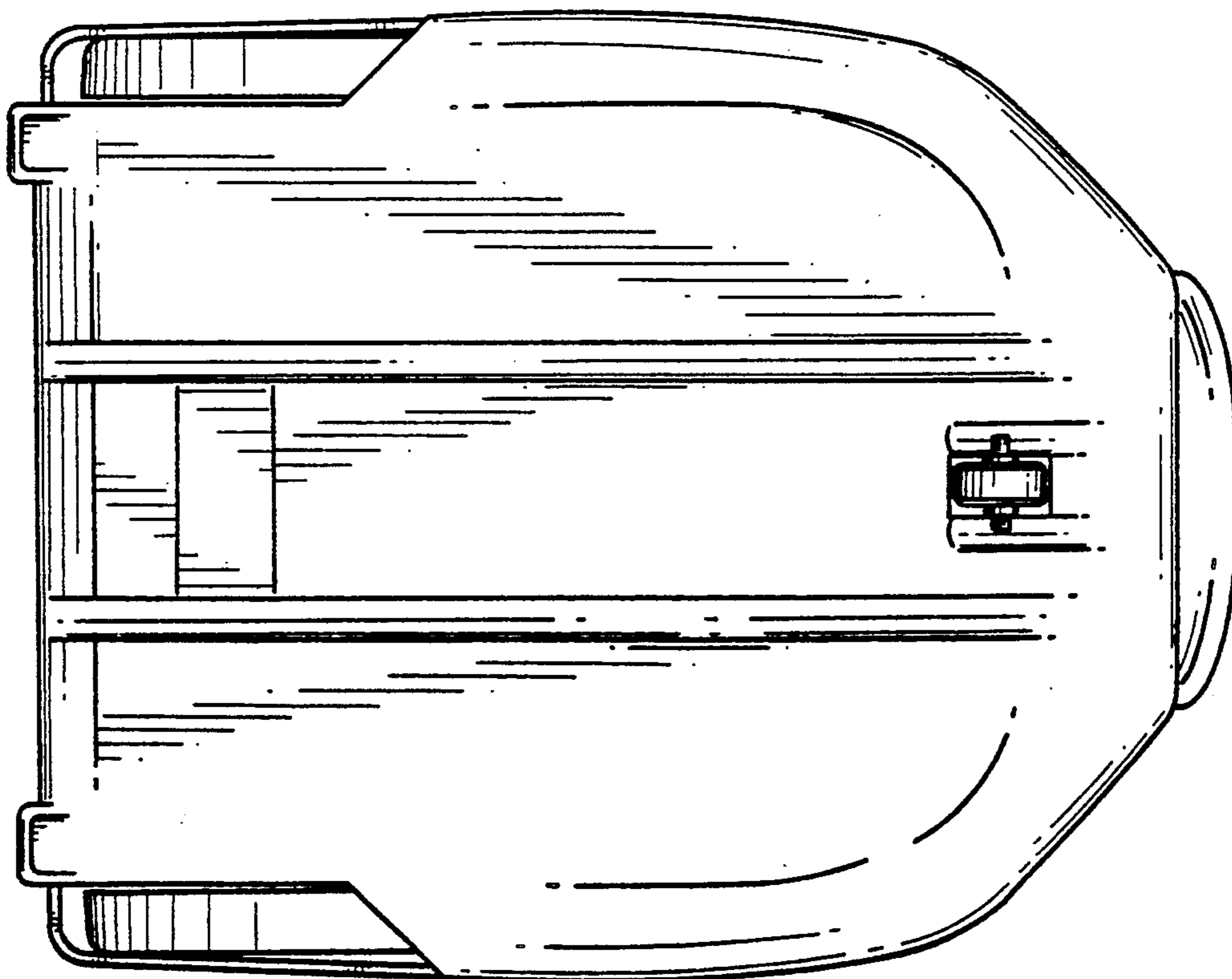

FIG. 4

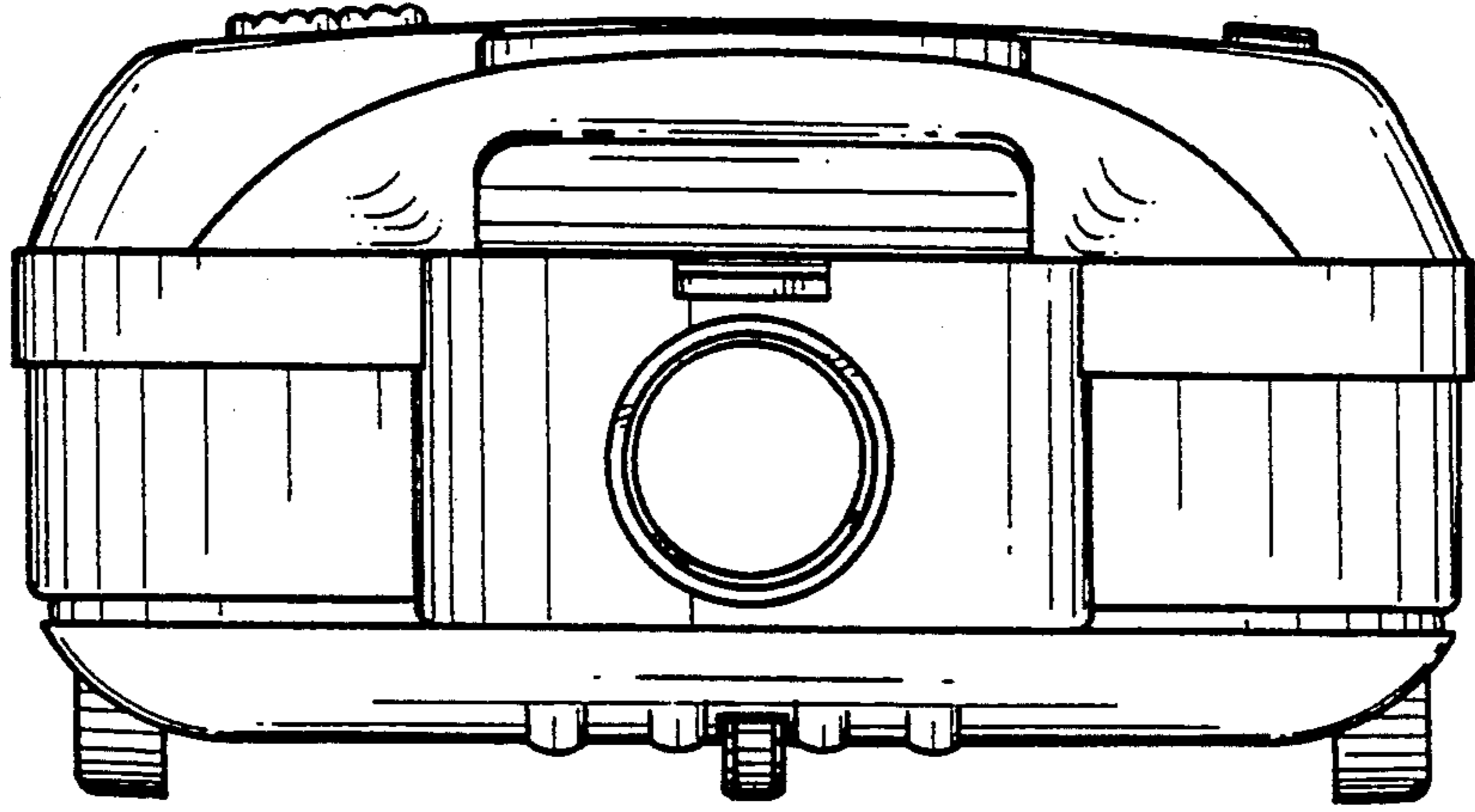

FIG. 5

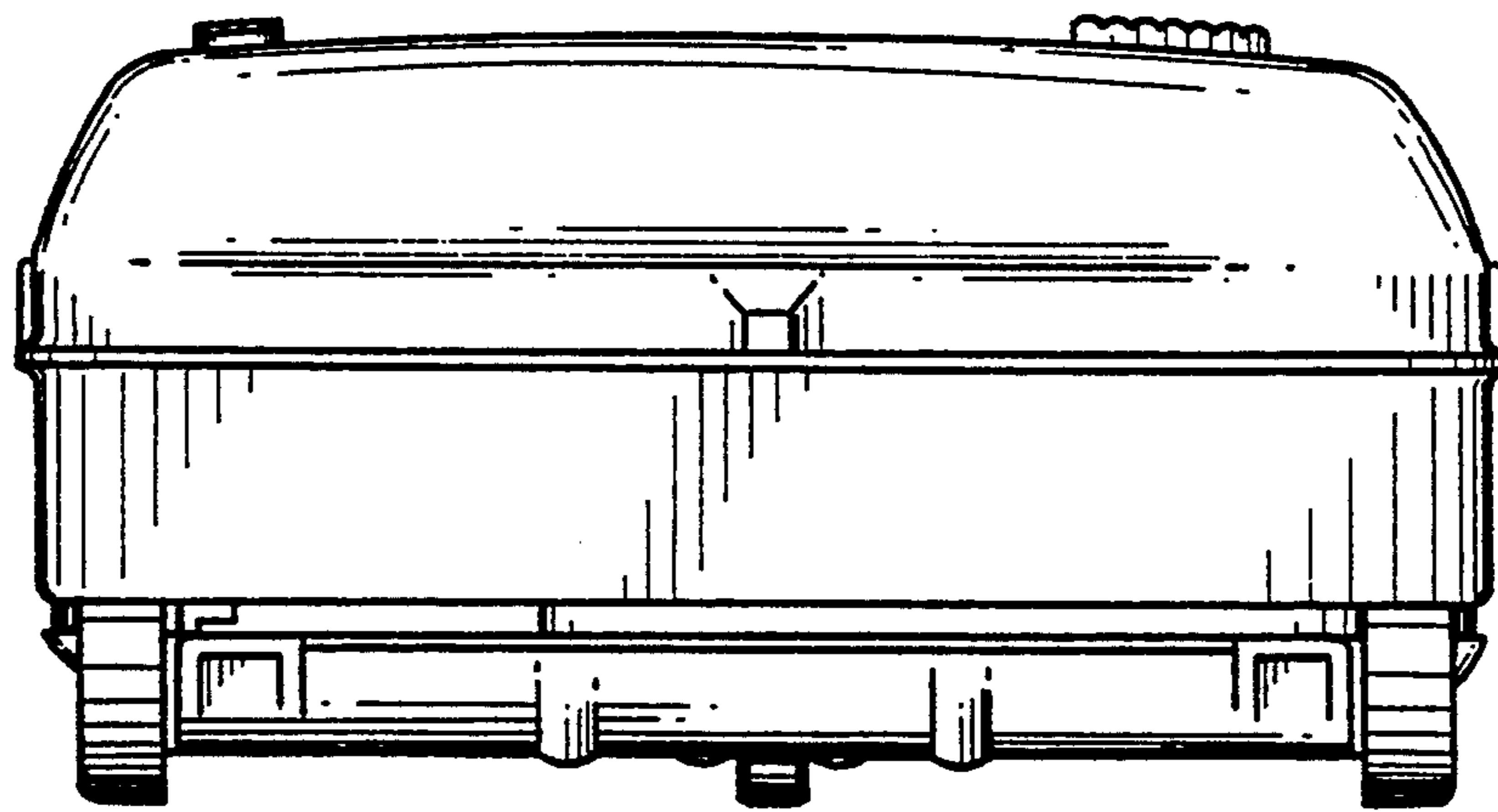

FIG. 6

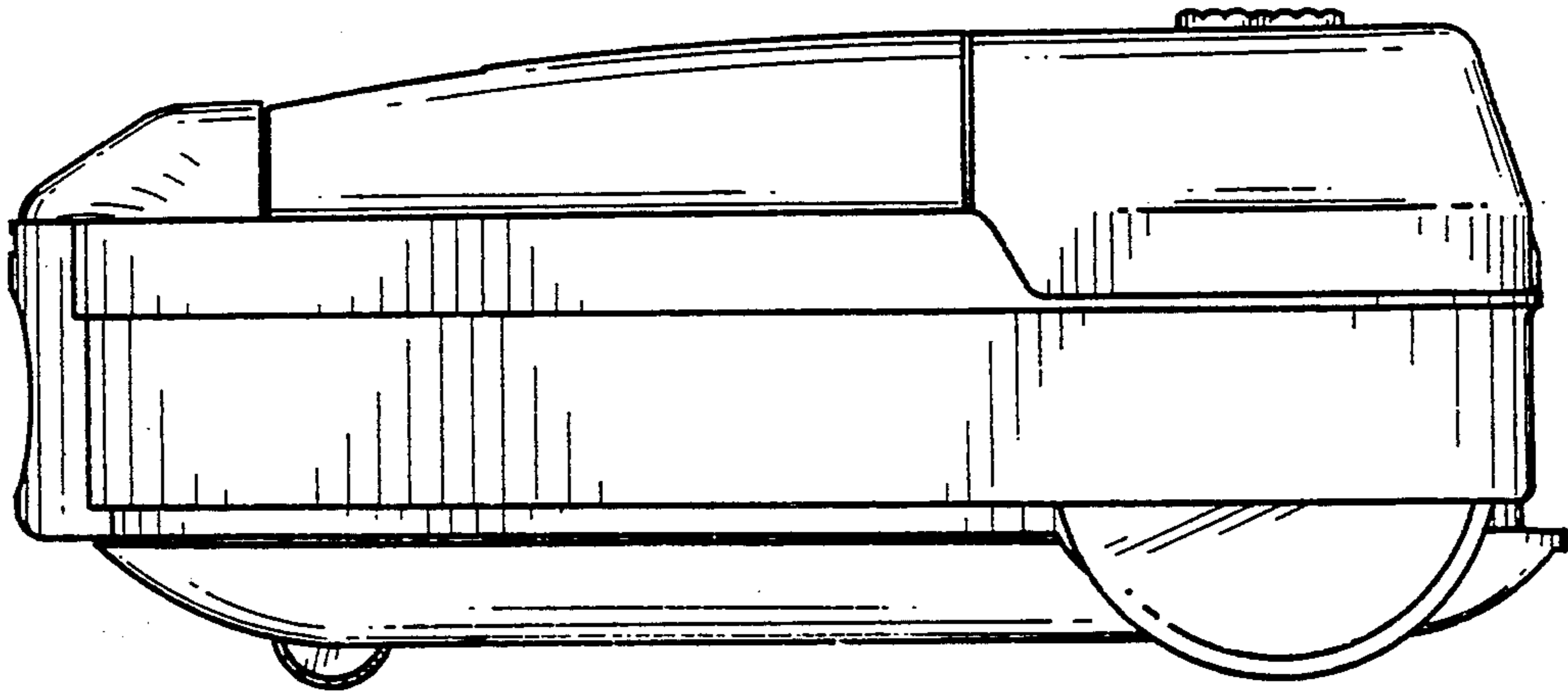

FIG. 7

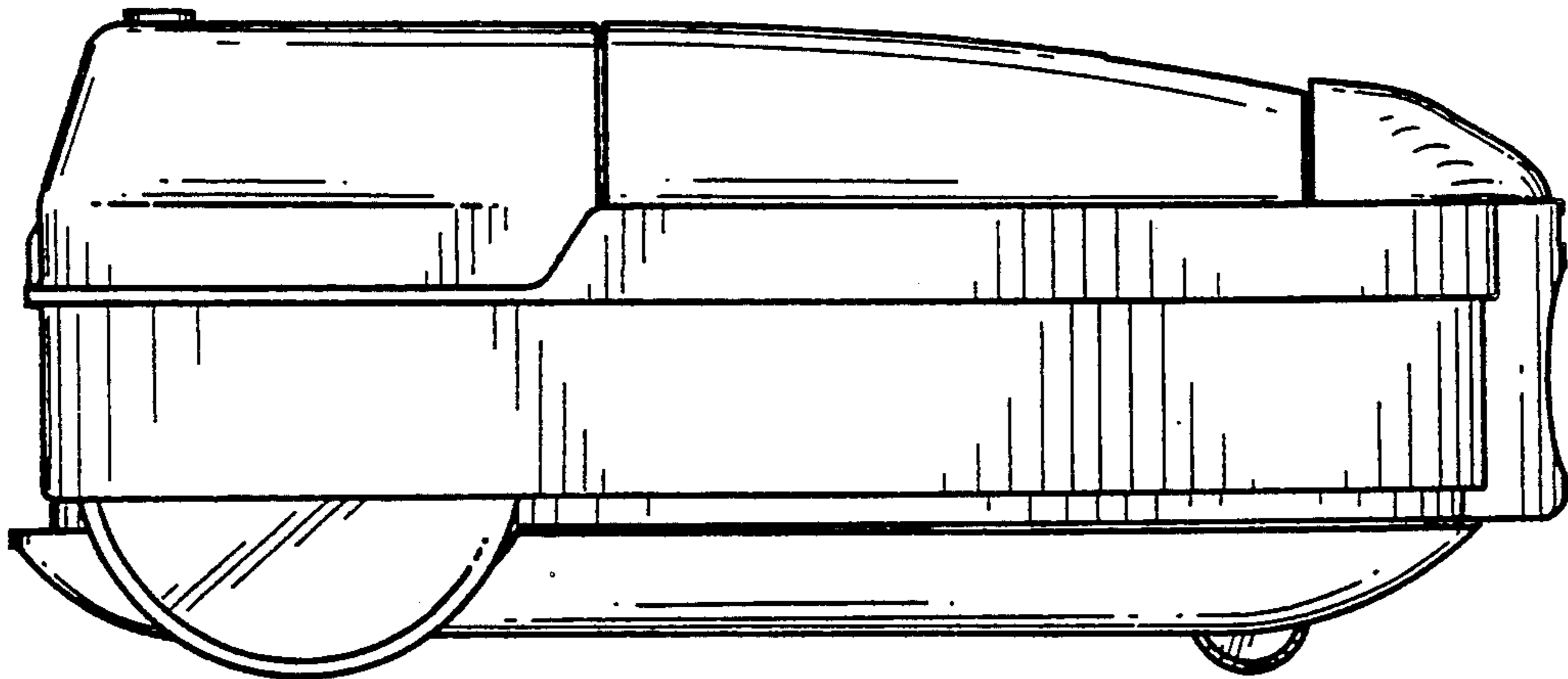

FIG. 8