



US00D324590S

United States Patent [19]

[11] Patent Number: Des. 324,590

Pixler

[45] Date of Patent: ** Mar. 10, 1992

[54] FISH TANK FACADE

[76] Inventor: William S. Pixler, 509 S. 670 E.,
Orem, Utah 84058

[**] Term: 14 Years

[21] Appl. No.: 613,363

[22] Filed: Nov. 14, 1990

[52] U.S. Cl. D30/102

[58] Field of Search D6/450; D21/130;
D11/163, 145, 158, 114; 119/5; D30/101-107

[56] **References Cited**

U.S. PATENT DOCUMENTS

D. 85,201	9/1931	Pomernacki	119/5
D. 130,750	12/1941	Schober	D11/163
D. 140,088	1/1945	Russell	D21/130
D. 151,879	11/1948	Foulke	D21/130
D. 216,429	1/1970	Greenbaum	D30/106
D. 216,474	1/1970	Tarrson	D21/130
D. 229,846	1/1974	Rae et al.	D21/130
3,807,356	4/1974	Pratt	119/5
4,723,930	2/1988	Freese et al.	D21/130

Primary Examiner—A. Hugo Word

Assistant Examiner—Cathy Anne MacCormac
Attorney, Agent, or Firm—Bryan A. Geurts

[57] **CLAIM**

The ornamental design for a fish tank facade, as shown and described.

DESCRIPTION

FIG. 1 is a top front perspective view of a fish tank facade showing my new design;

FIG. 2 is a left side elevational view thereof;

FIG. 3 is a right side elevational view thereof;

FIG. 4 is a front elevational view thereof;

FIG. 5 is a rear elevational view thereof;

FIG. 6 is a top plan view thereof;

FIG. 7 is a bottom plan view thereof;

FIG. 8 is a top front perspective view of a second embodiment of FIG. 1;

FIG. 9 is a left side elevational view thereof;

FIG. 10 is a right side elevational view thereof;

FIG. 11 is a front elevational view thereof;

FIG. 12 is a rear elevational view thereof;

FIG. 13 is a top plan view thereof; and

FIG. 14 is a bottom plan view thereof.

The broken lines in FIGS. 1 and 8 are for purposes of illustration and form no part of the claimed design.

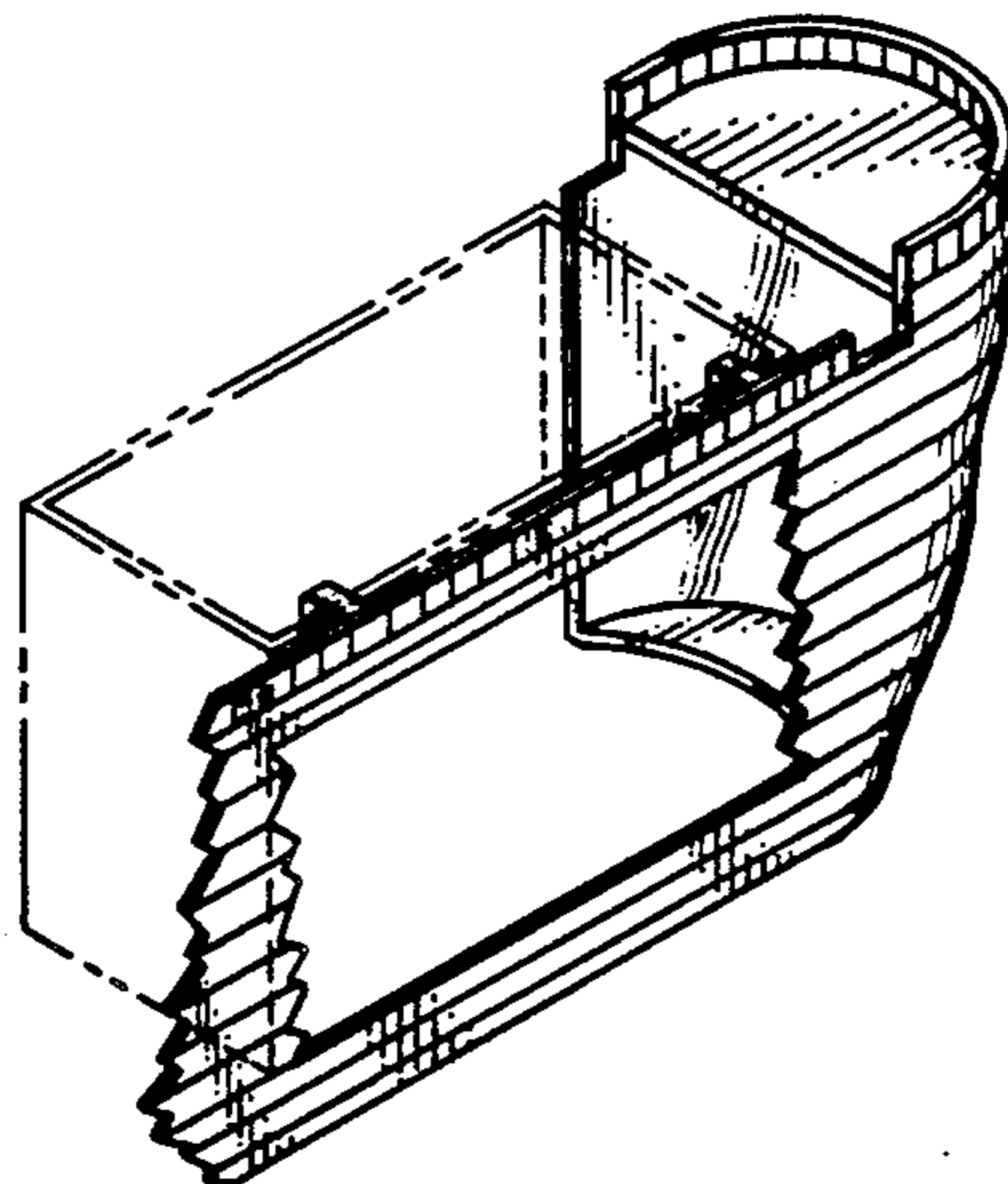
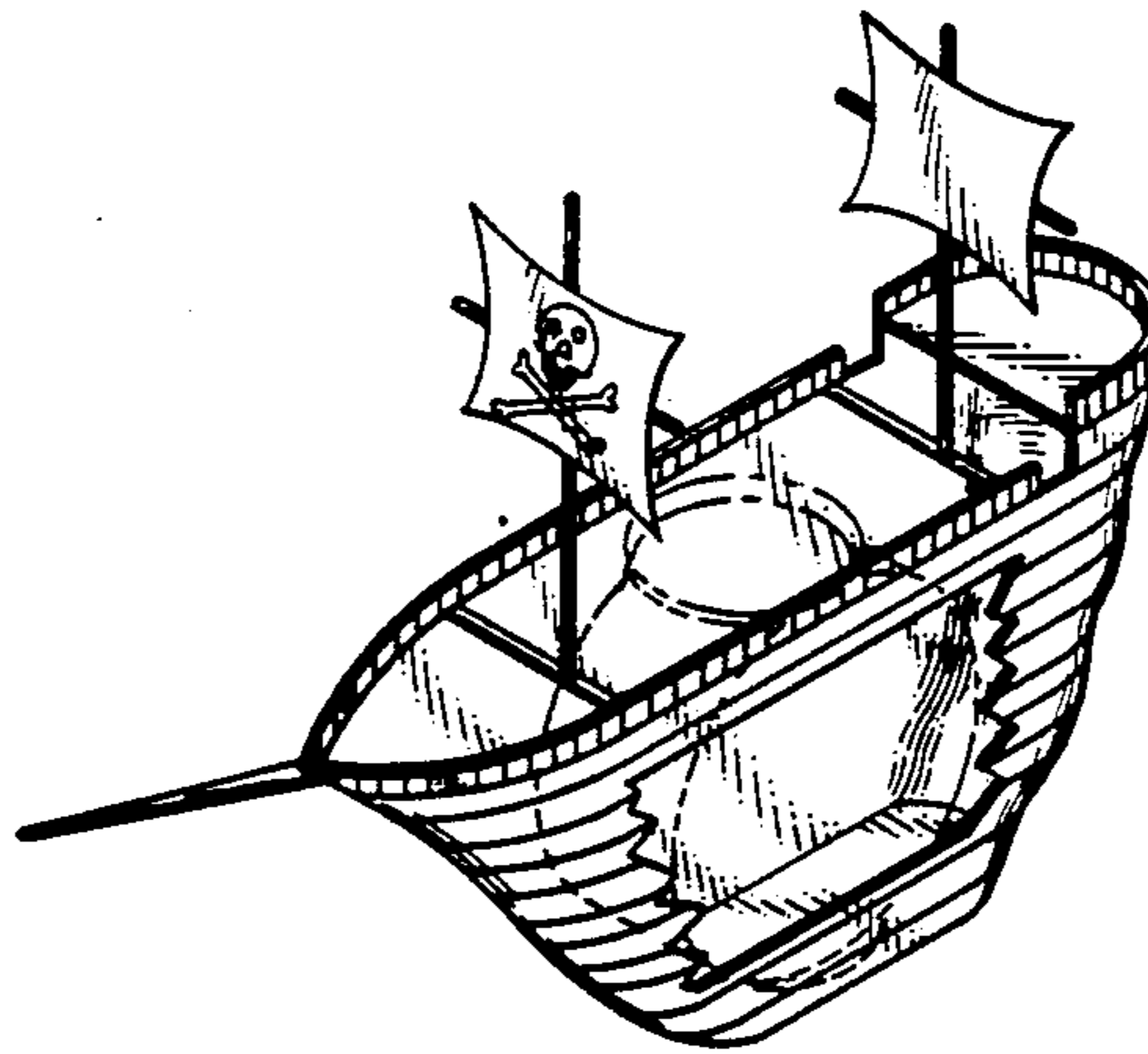

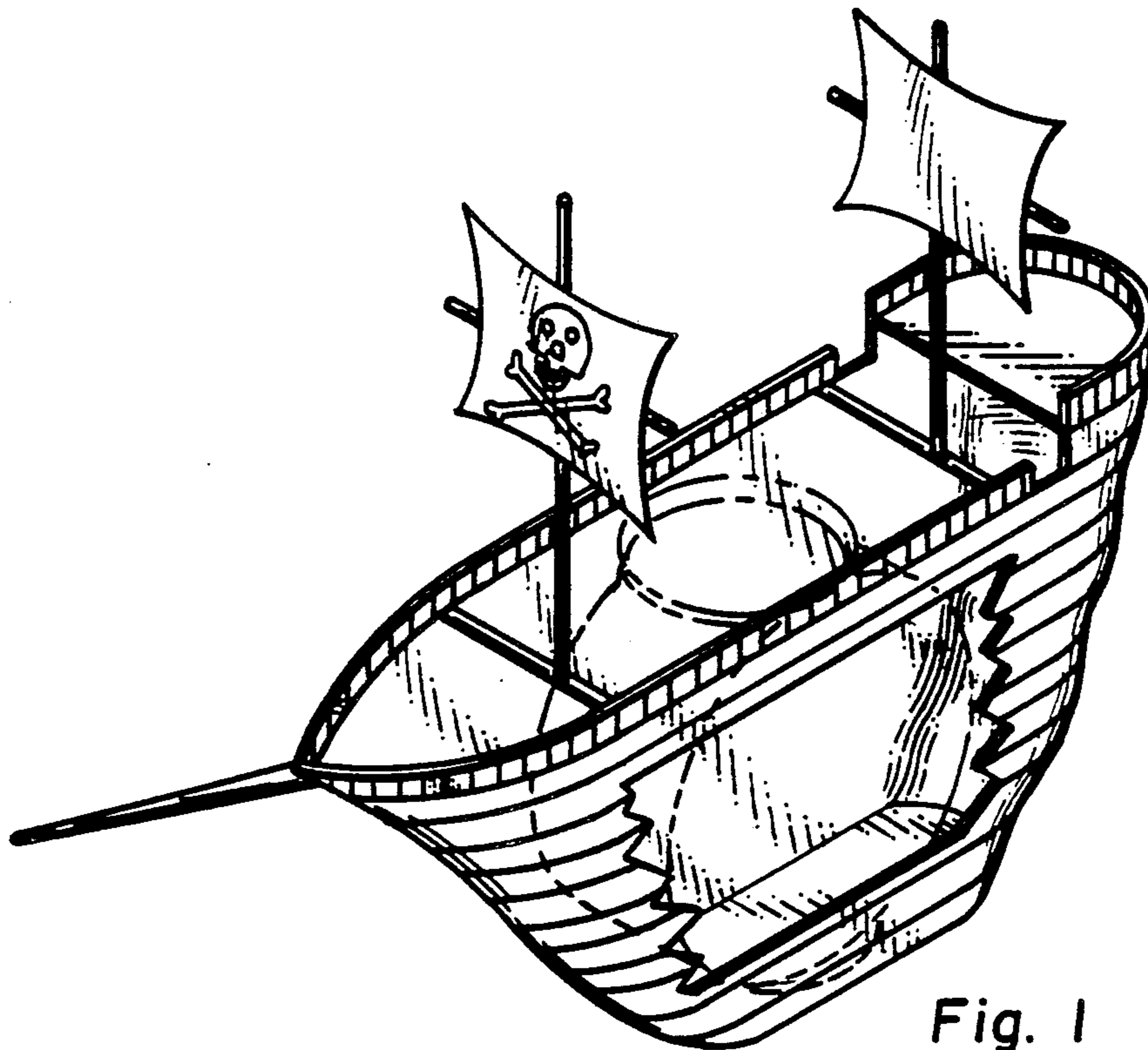

Fig. 1

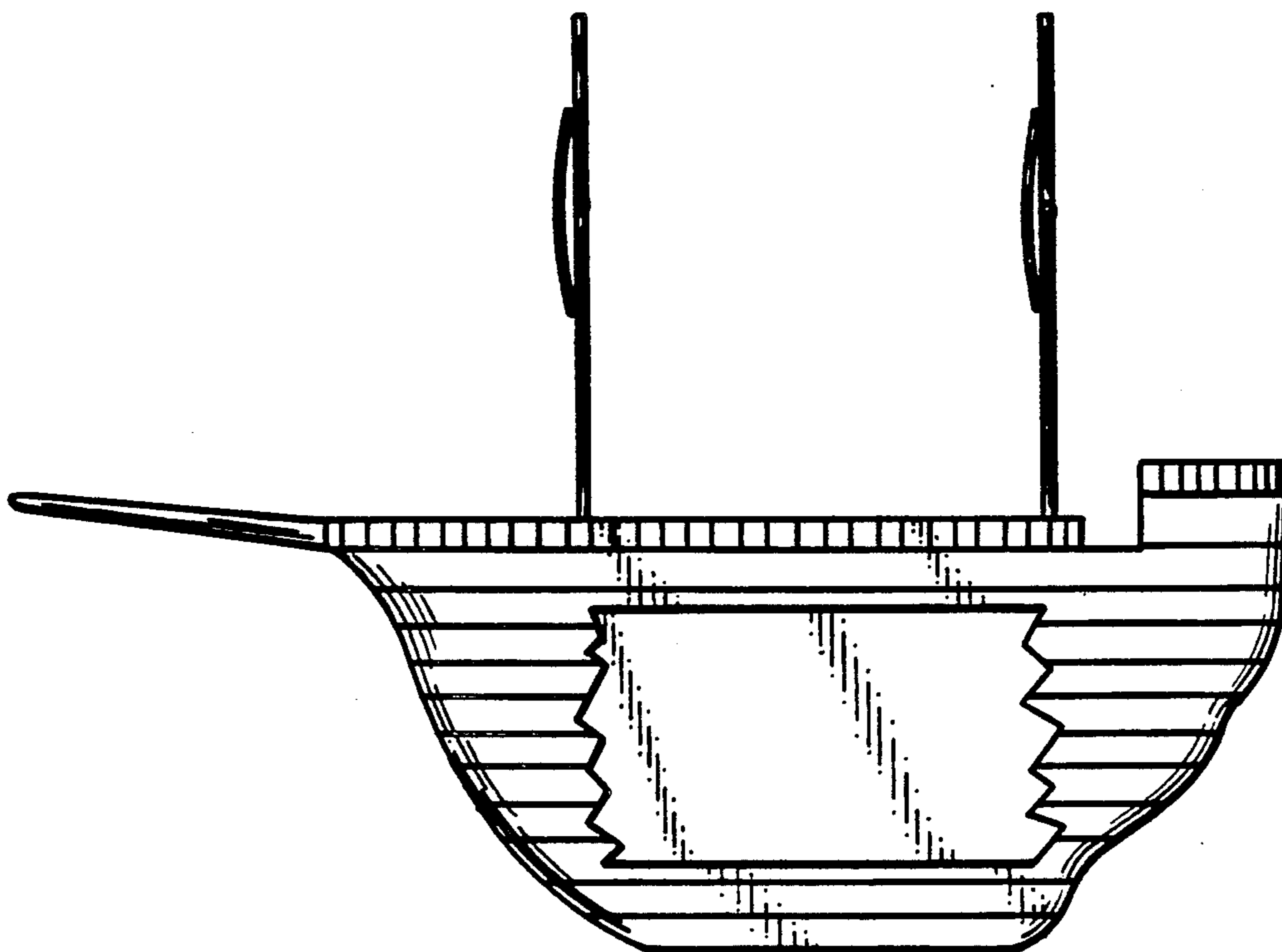

Fig. 2

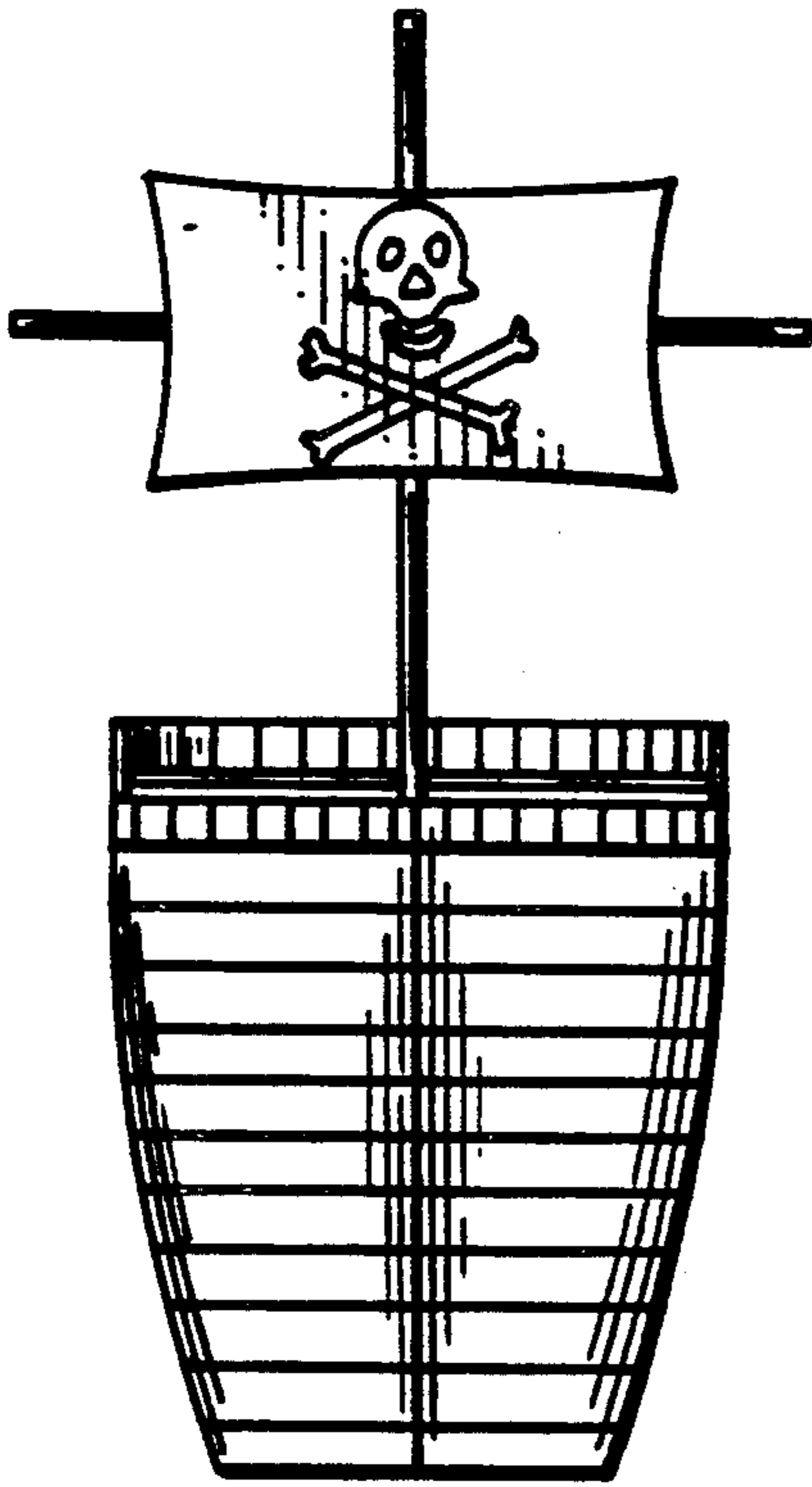

Fig. 4

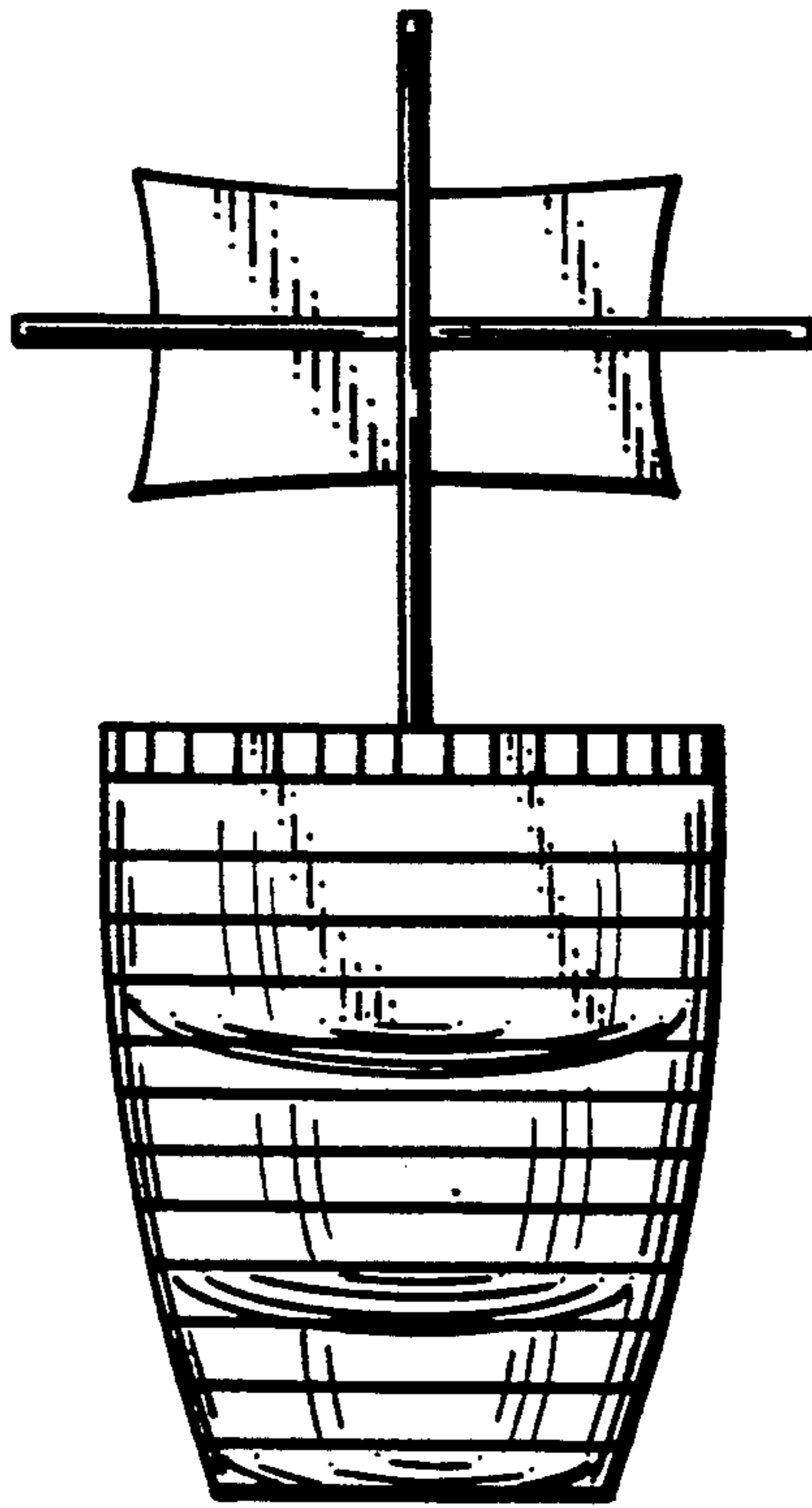

Fig. 5

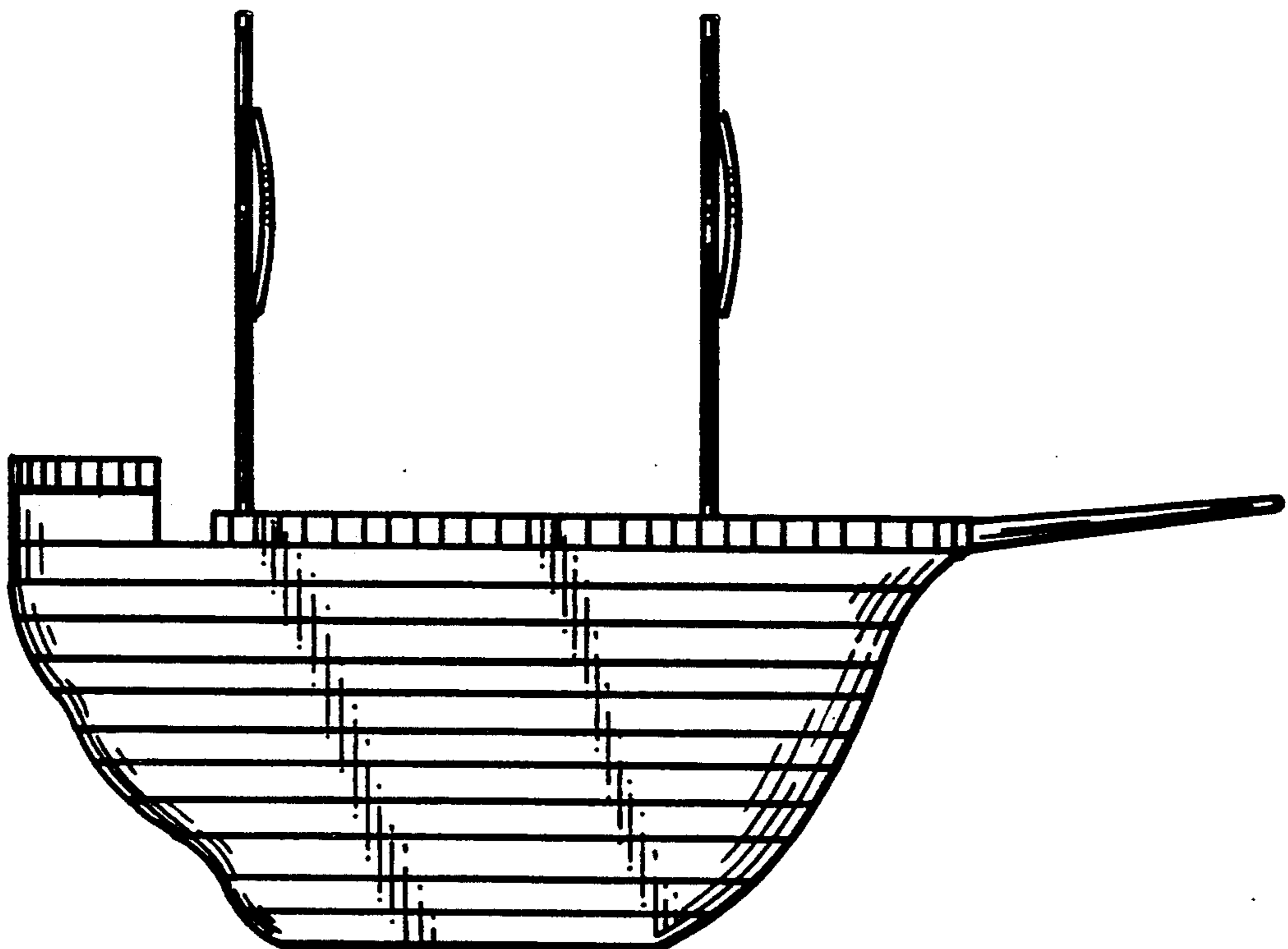

Fig. 3

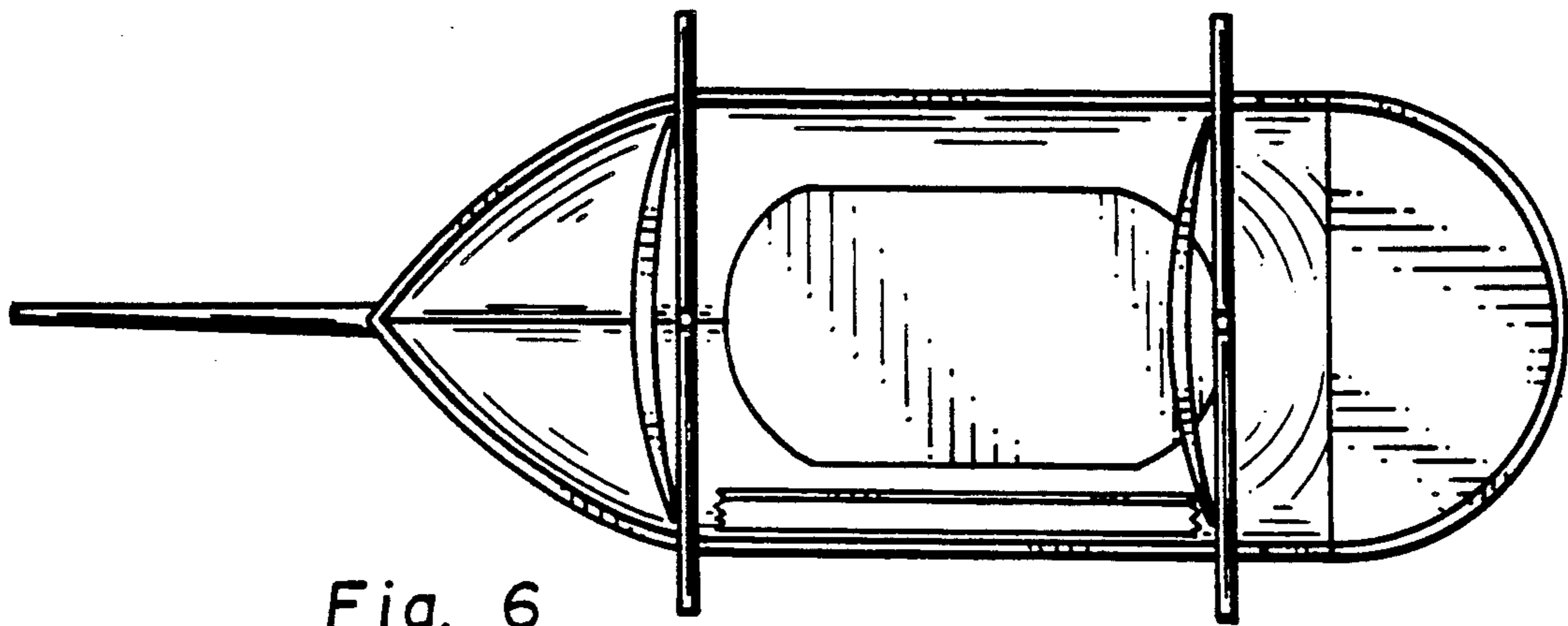

Fig. 6

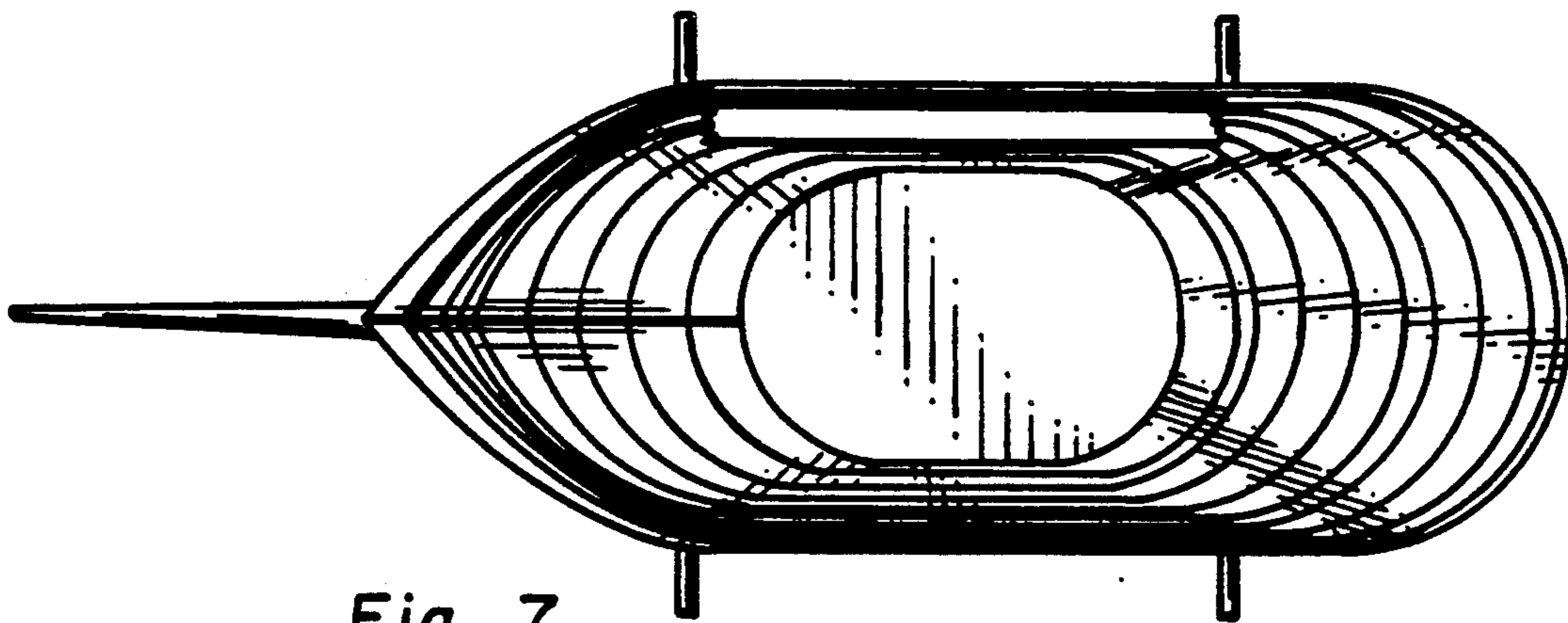

Fig. 7

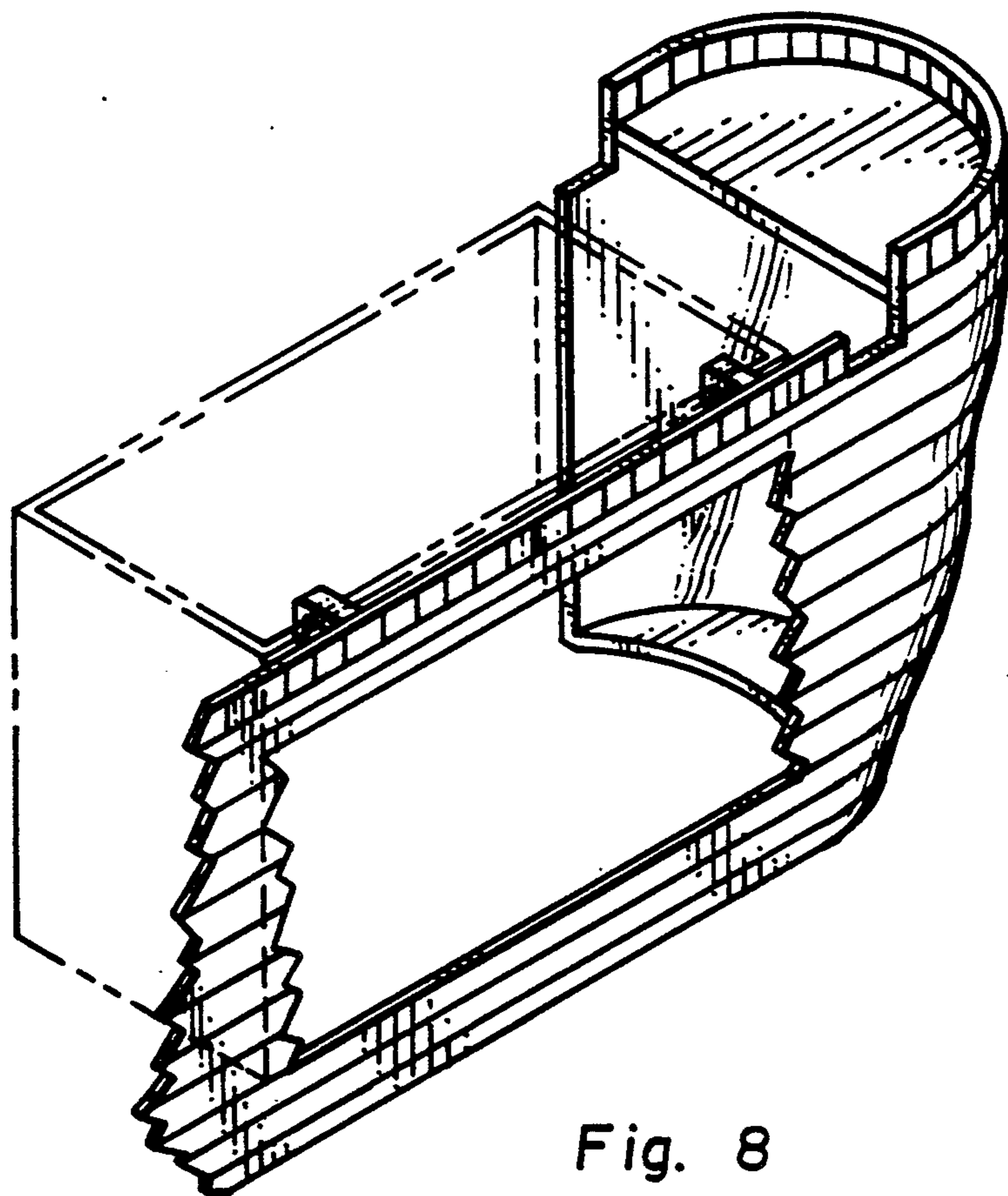

Fig. 8

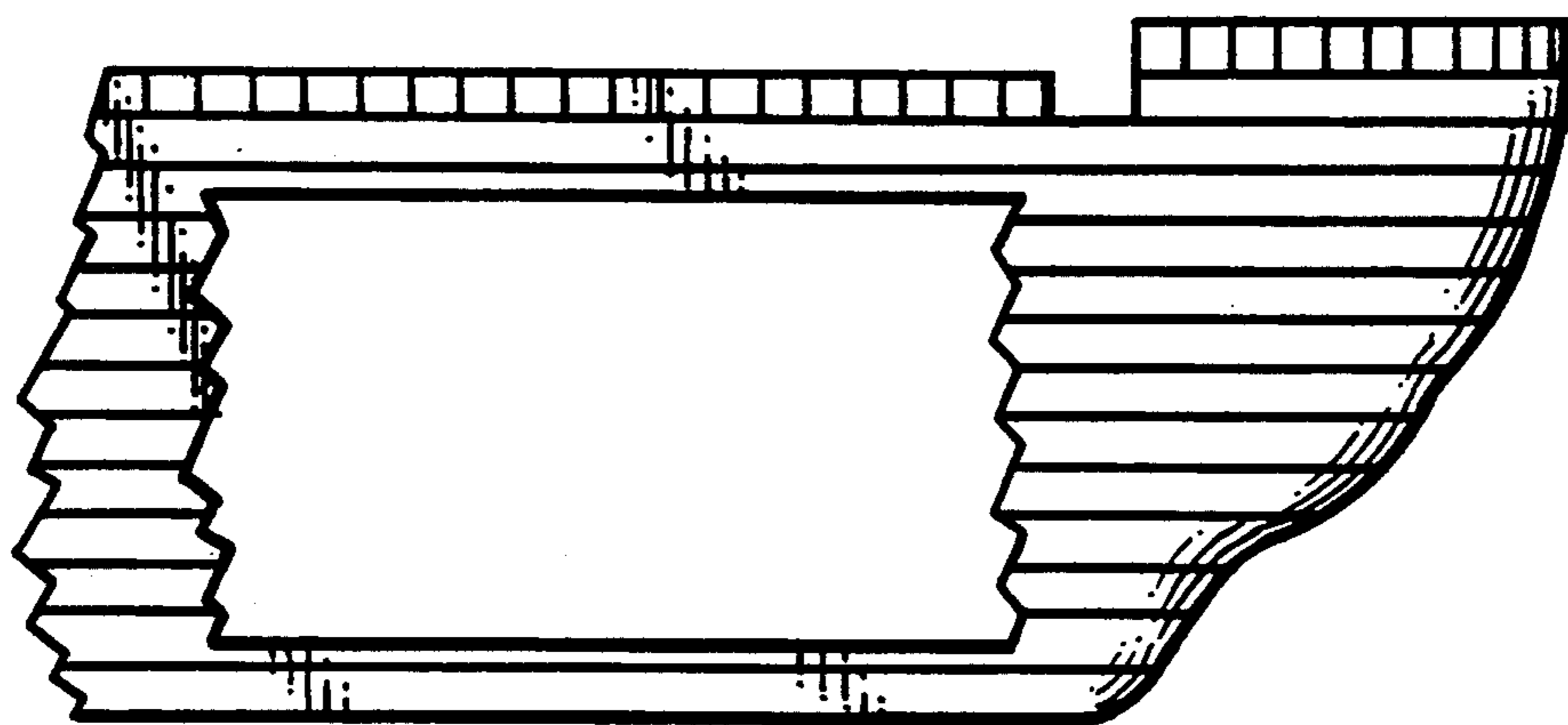

Fig. 9

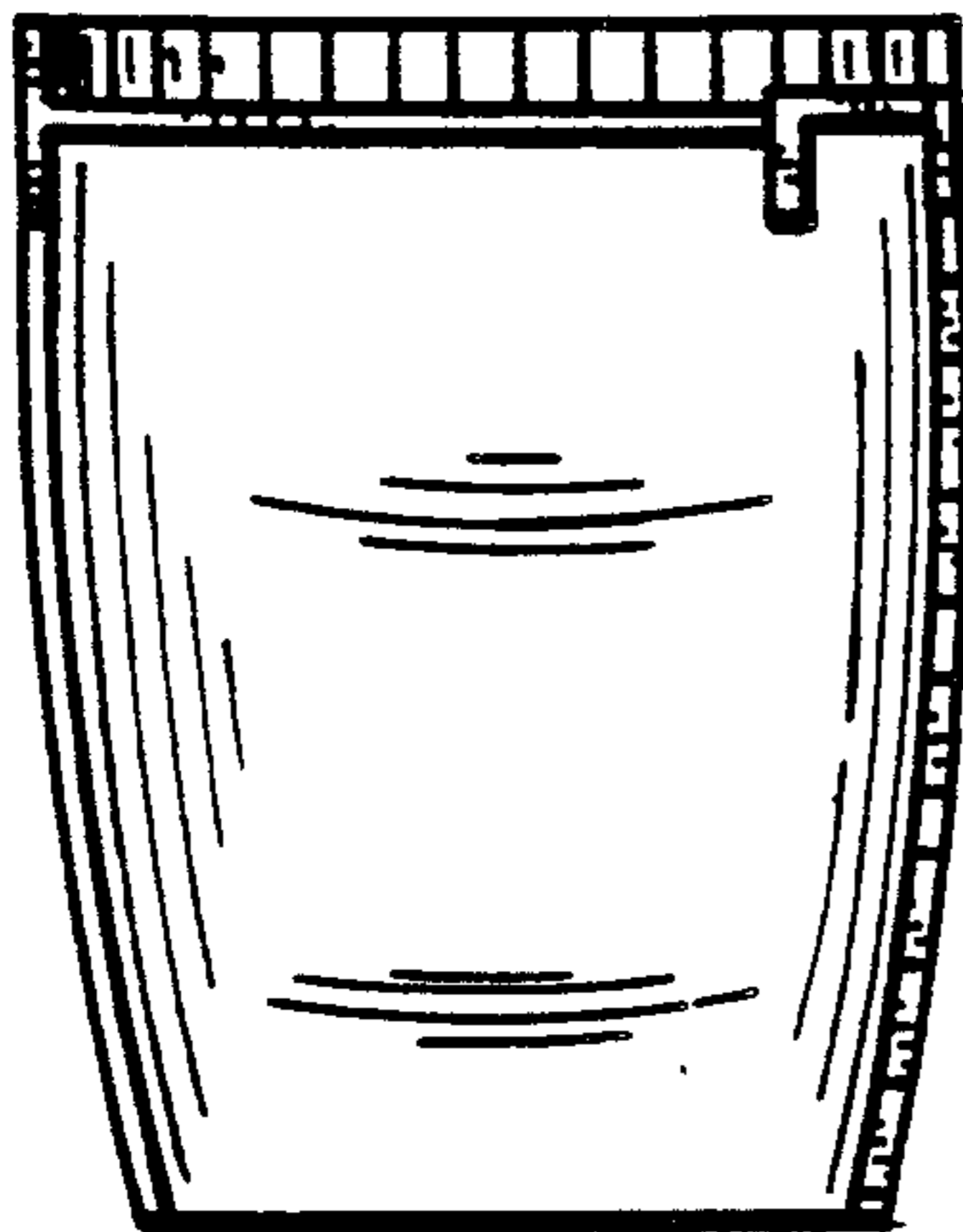

Fig. 11

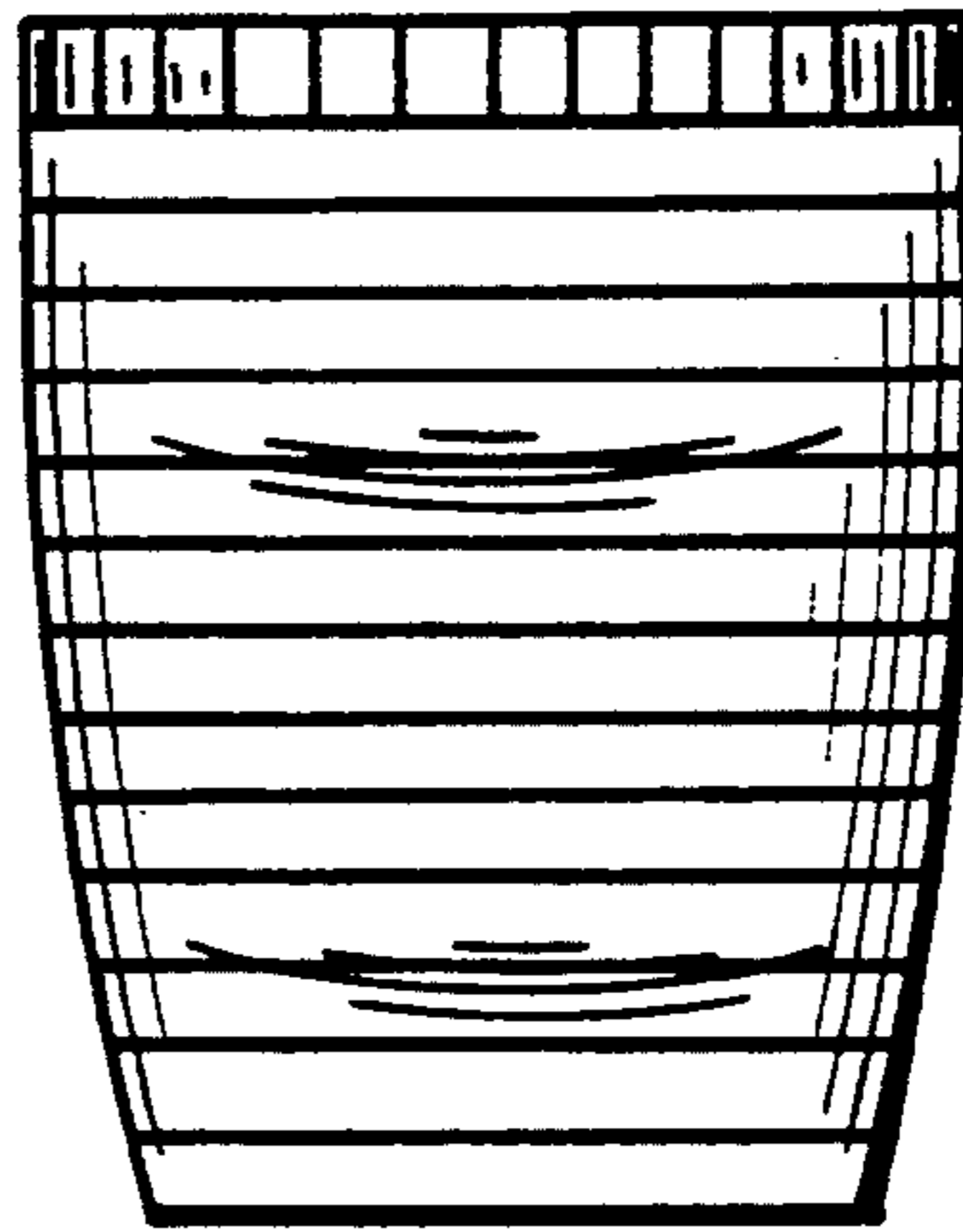

Fig. 12

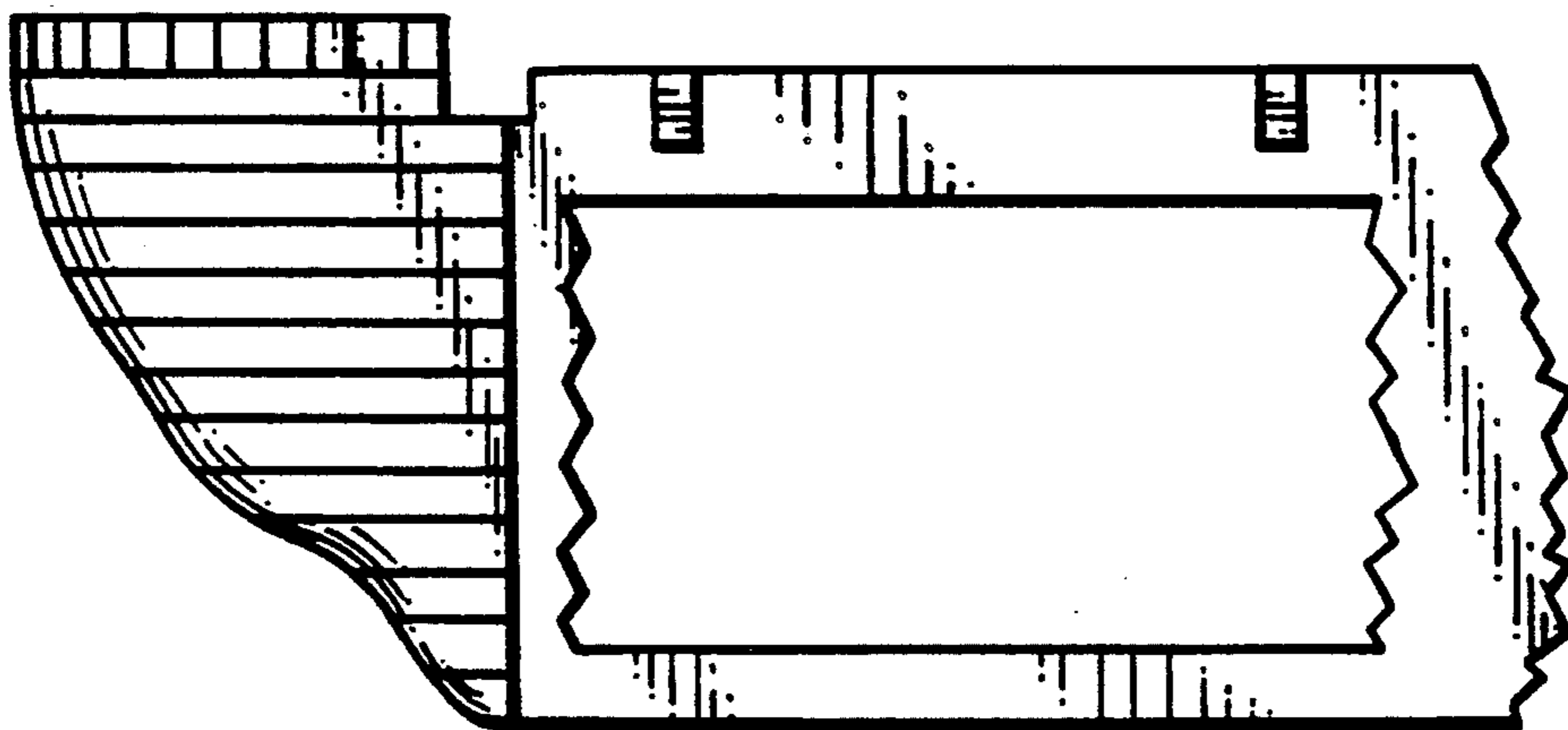

Fig. 10

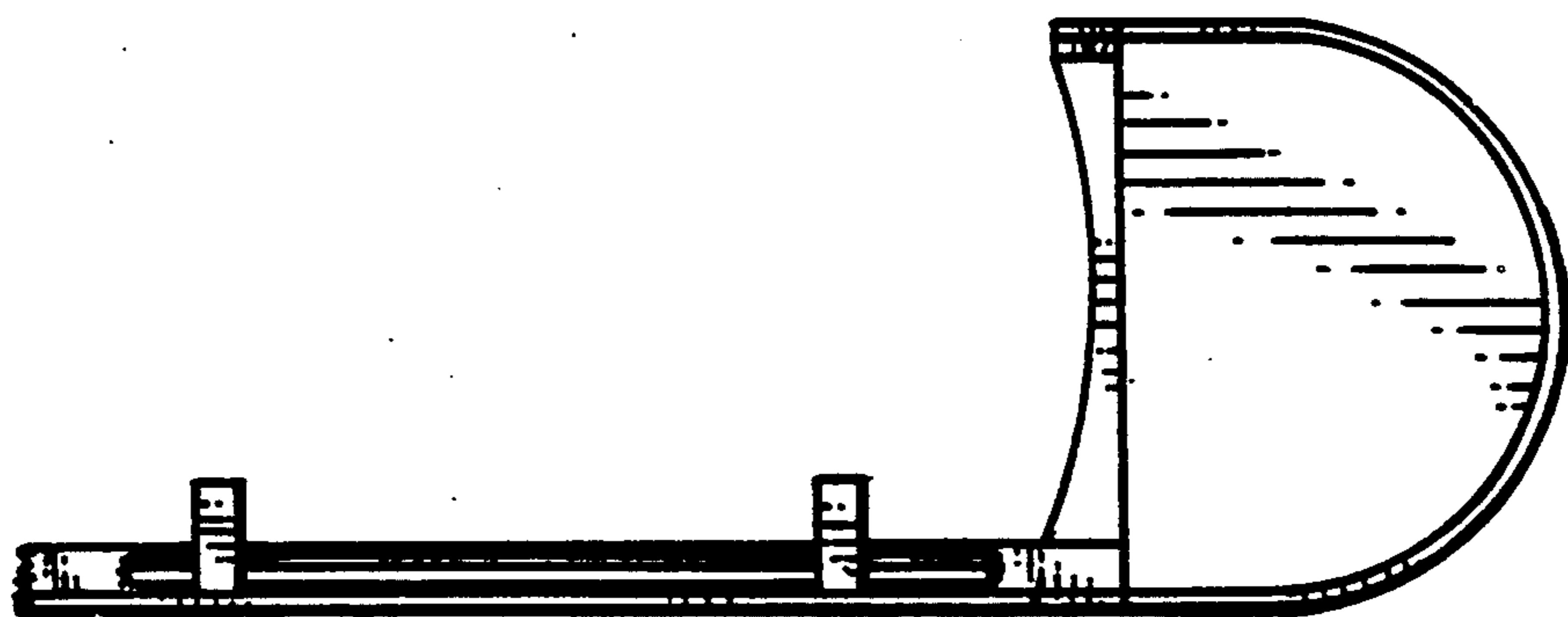

Fig. 13

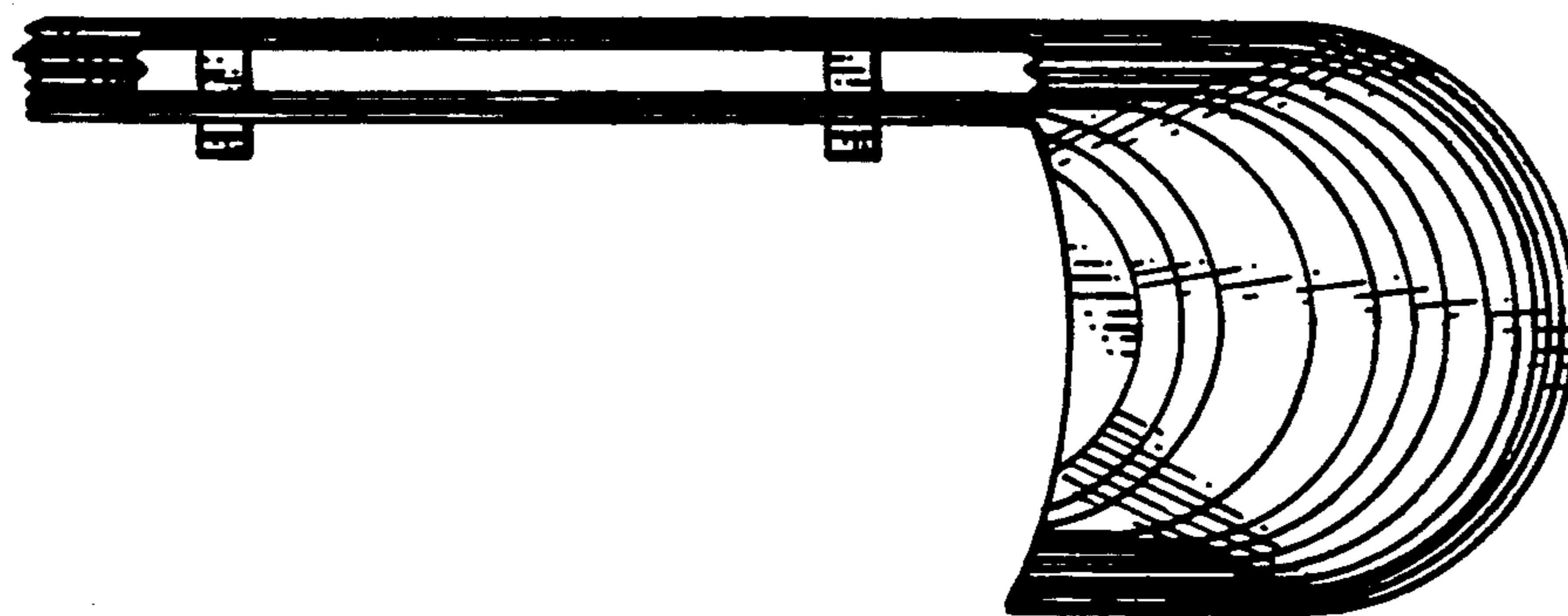

Fig. 14