



US00D324504S

# United States Patent [19]

Olsen

[11] Patent Number: Des. 324,504

[45] Date of Patent: \*\* Mar. 10, 1992

[54] CARRIER FOR USE WITH A WALKER

4,974,760 12/1990 Miller ..... 224/42.46 R

[76] Inventor: Flora L. Olsen, 2323 Calle Corta, La Jolla, Calif. 92037

Primary Examiner—Kay H. Chin  
Attorney, Agent, or Firm—Joseph C. Schwalbach

[\*\*] Term: 14 Years

[57] CLAIM

[21] Appl. No.: 330,422

The ornamental design for a carrier for use with a walker, as shown and described.

[22] Filed: Mar. 29, 1989

DESCRIPTION

[52] U.S. Cl. .... D12/133; D12/130

[58] Field of Search ..... D12/133, 130, 128;  
224/42.46 R; 220/23.83

FIG. 1 is a top and front perspective view of a carrier for use with a walker showing my new designs, the broken lines are for illustrative purposes only and form no part of the claimed design;

[56] References Cited

U.S. PATENT DOCUMENTS

- D. 293,663 1/1988 Erfurth ..... D12/130
- 4,676,416 6/1987 Harmon ..... 224/42.46 R
- 4,946,058 8/1990 Stamm ..... 220/23.83

- FIG. 2 is front elevational view thereof;
- FIG. 3 is a top plan view thereof;
- FIG. 4 is a left side elevational view thereof;
- FIG. 5 is a bottom plan view thereof; and
- FIG. 6 is a rear elevation view thereof;

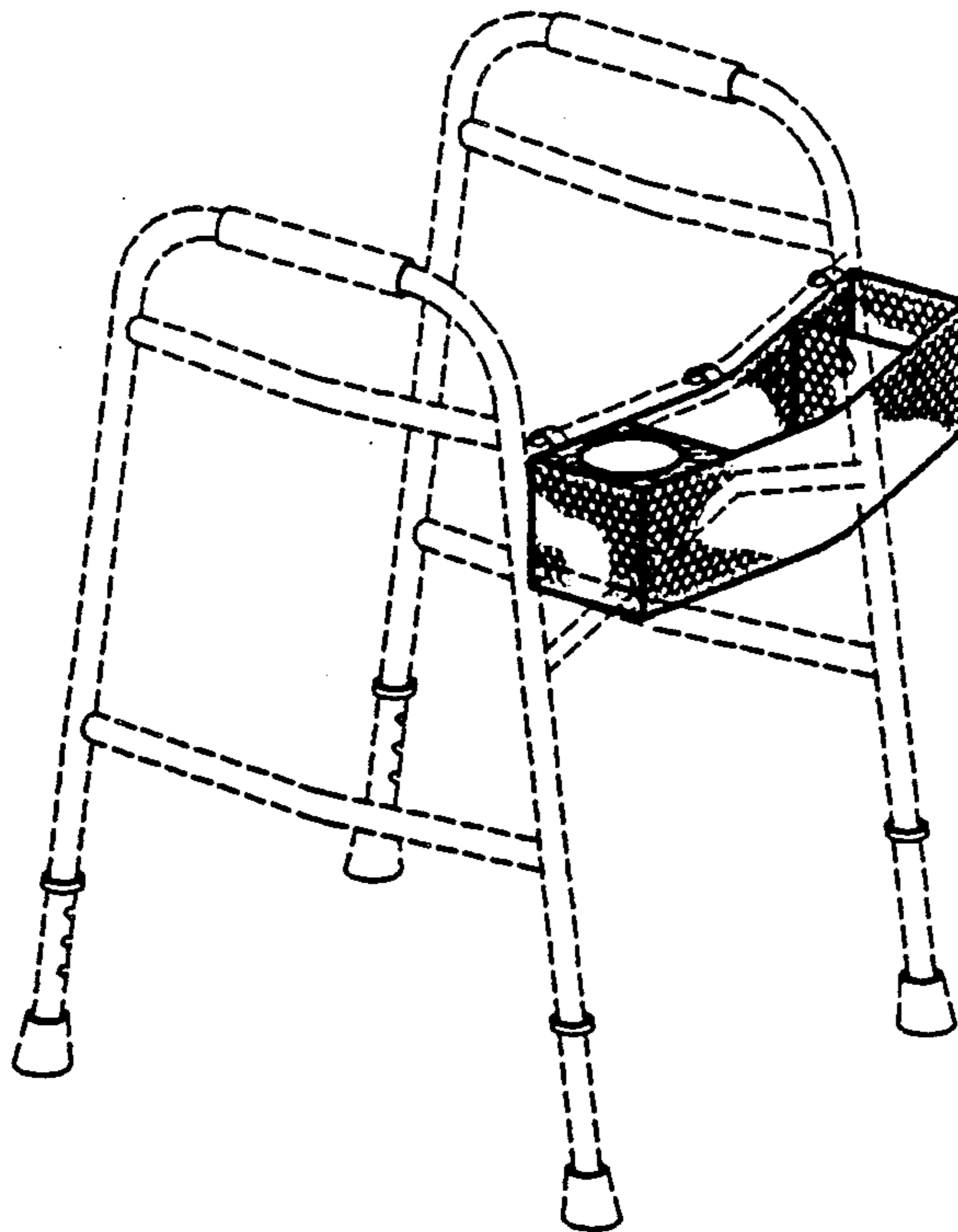

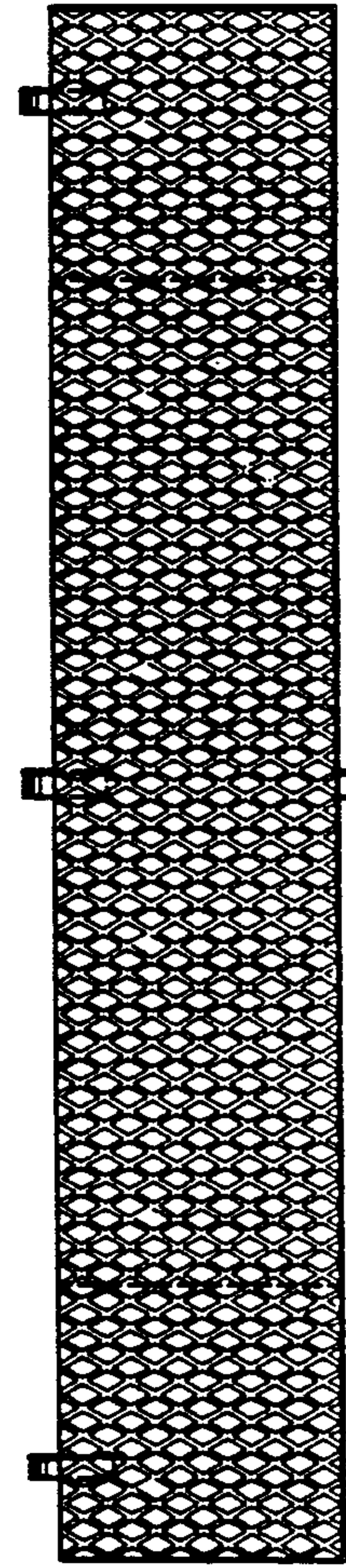

FIG. 2

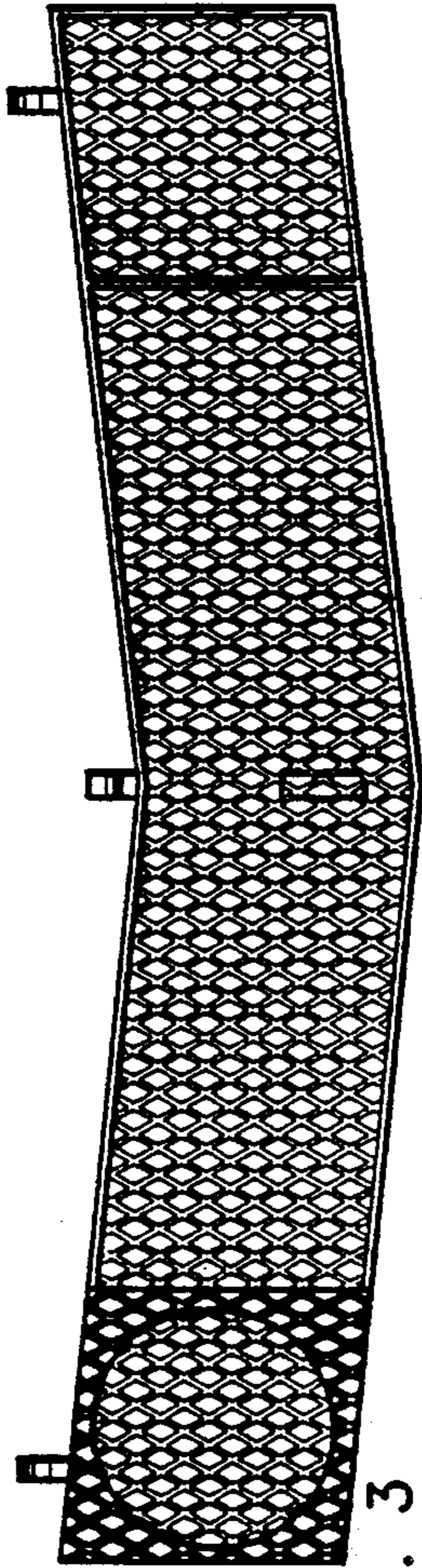

FIG. 3

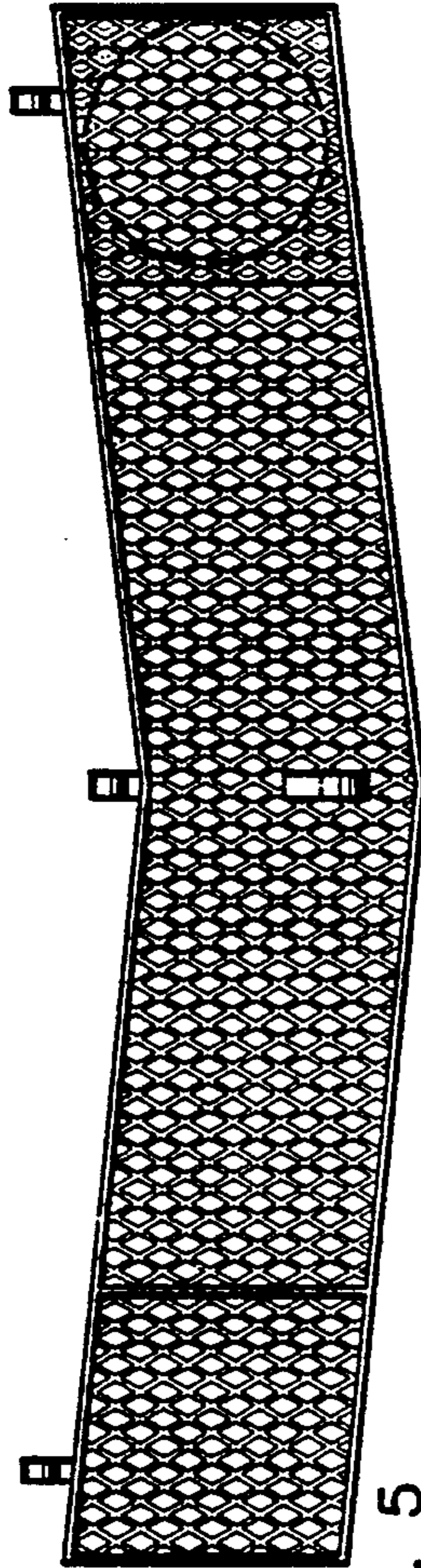

FIG. 5

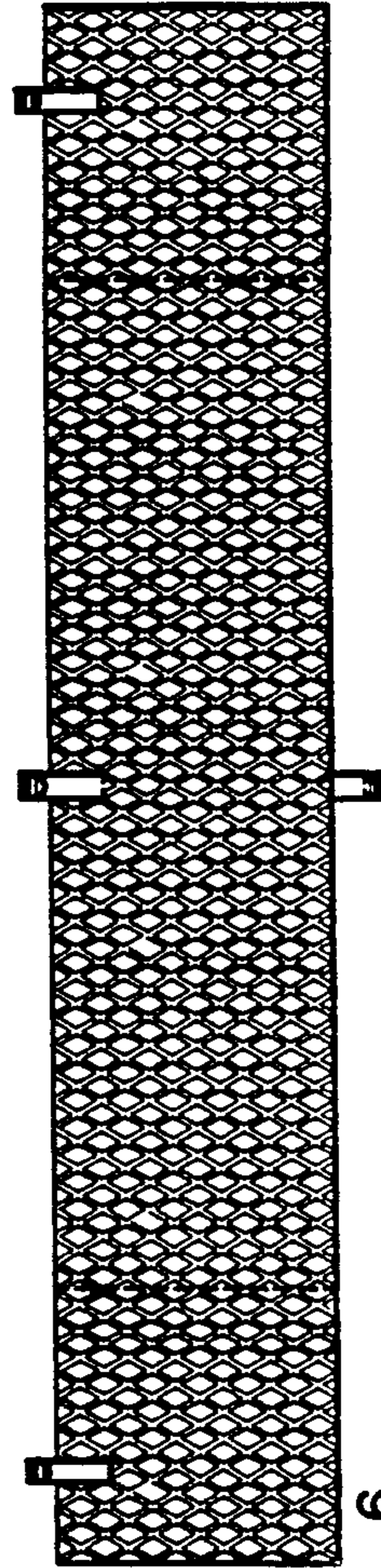

FIG. 6

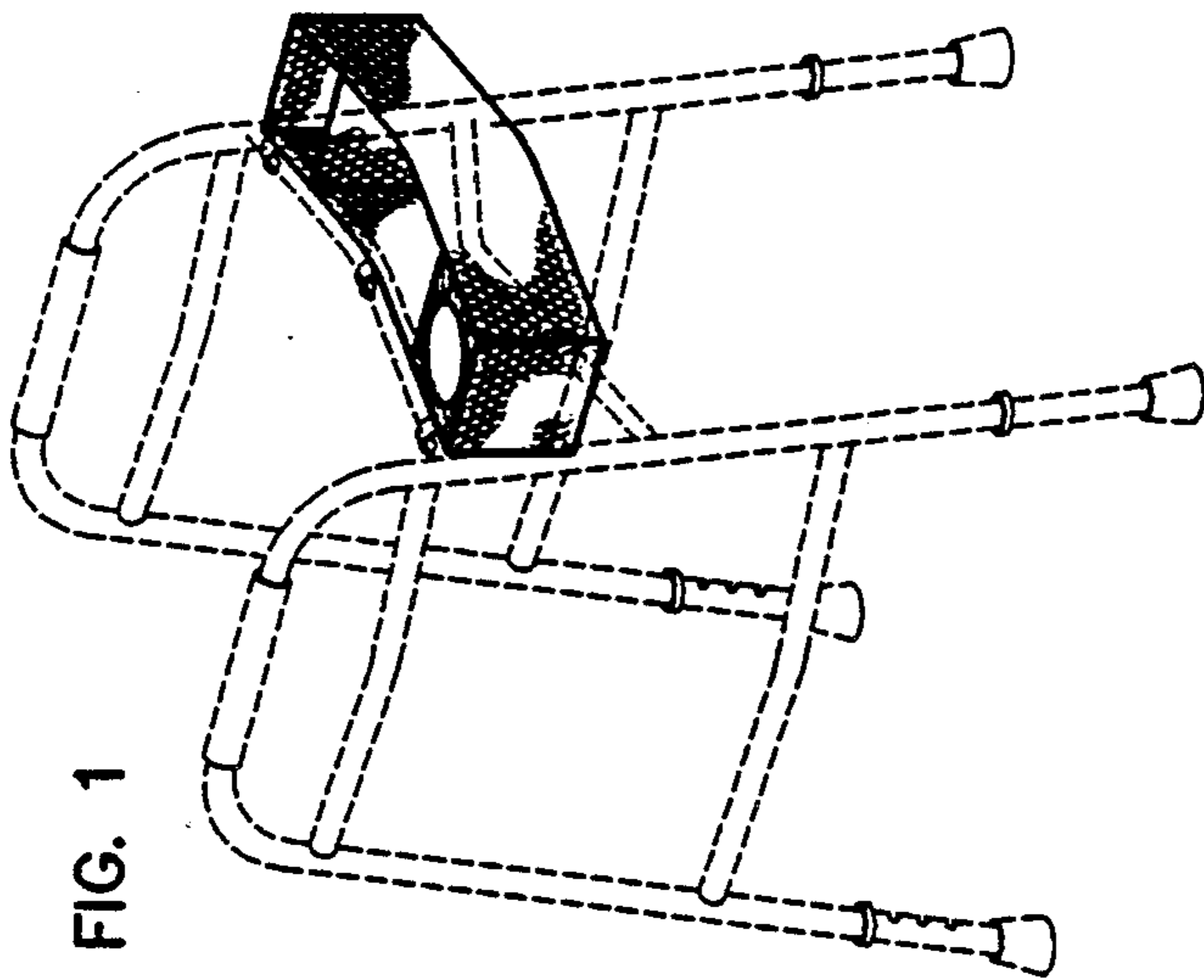

FIG. 1

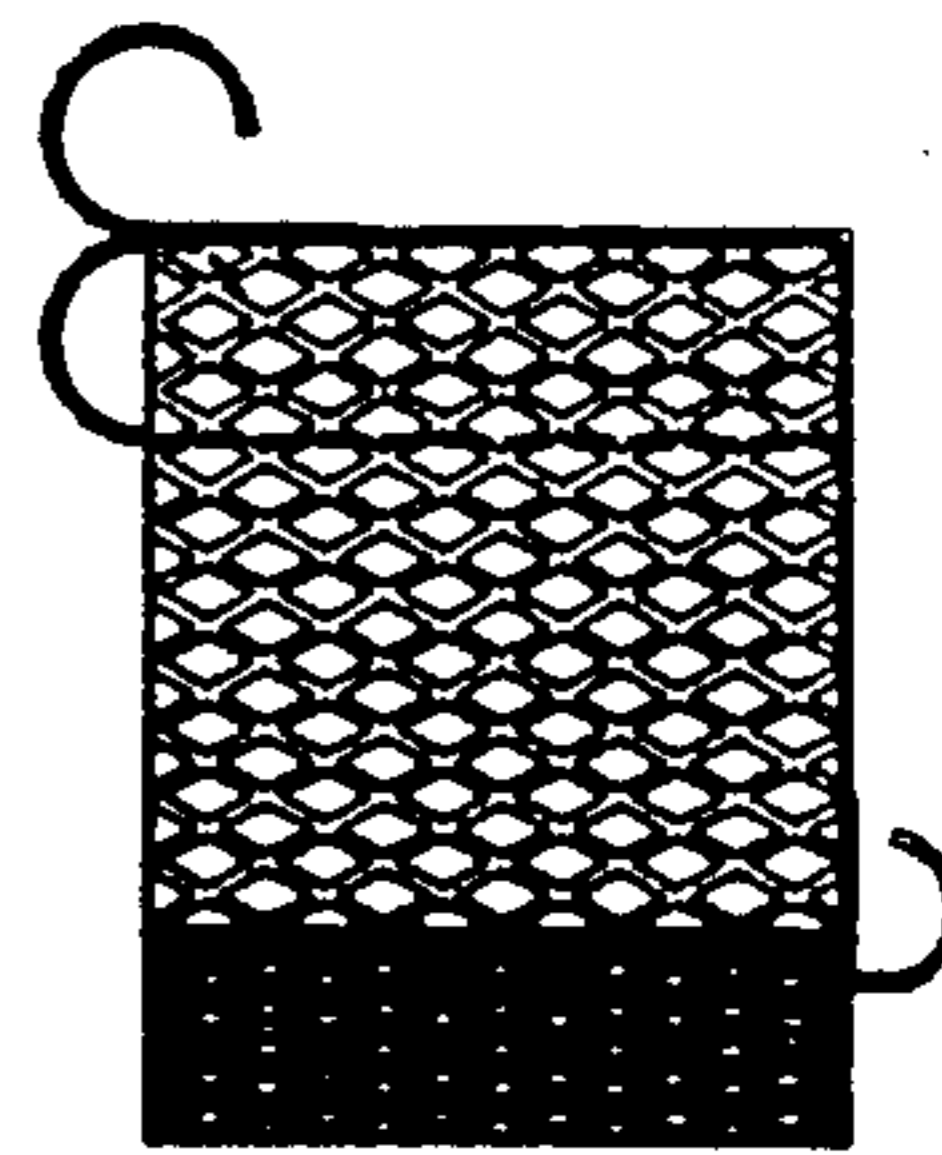

FIG. 4