



US00D324475S

United States Patent [19]

Staubitz et al.

[11] Patent Number: Des. 324,475

[45] Date of Patent: ** Mar. 10, 1992

- [54] RETRACTABLE BLADE KNIFE
- [75] Inventors: Robert B. Staubitz, Collinsville;
William H. Valls, Harwinton; Robert
H. Bruno, Avon, all of Conn.
- [73] Assignee: Hunt Holdings, Inc., Wilmington,
Del.
- [*] Notice: The portion of the term of this patent
subsequent to Aug. 10, 2007 has been
disclaimed.
- [**] Term: 14 Years
- [21] Appl. No.: 331,885
- [22] Filed: Mar. 31, 1989
- [52] U.S. Cl. D8/99
- [58] Field of Search D8/98, 99; 3/161, 162,
3/320, 329, 335, 337

- D. 305,096 12/1989 Tench et al. D8/99
- D. 305,609 1/1990 Tsuji D8/99
- 4,226,020 10/1980 Quenot et al. 30/162
- 4,233,734 11/1980 Bies 30/162
- 4,240,202 12/1980 Gilbert 30/162

OTHER PUBLICATIONS

Hong Kong Enterprise, 4-1983, p. 196, Razor knives.
DIY Retailing, Aug. 1985, 375, Olfa ad.

Primary Examiner—Bernard Ansher
Assistant Examiner—Philip Hyder
Attorney, Agent, or Firm—Synnestvedt & Lechner

[57] CLAIM

The ornamental design for a retractable blade knife, as shown.

DESCRIPTION

FIG. 1 is a perspective view of a retractable blade knife showing our new design;
FIG. 2 is a front elevational view thereof;
FIG. 3 is a rear elevational view thereof;
FIG. 4 is a top plan view thereof;
FIG. 5 is a bottom plan view thereof;
FIG. 6 is a left side elevational view thereof; and
FIG. 7 is a right side elevational view of the other end thereof.

[56] References Cited U.S. PATENT DOCUMENTS

- D. 263,277 3/1982 Gregoire D8/99
- D. 264,799 6/1982 Osada D8/99
- D. 264,800 6/1982 Osada D8/99
- D. 264,801 6/1982 Osada D8/99
- D. 264,802 6/1982 Osada D8/99
- D. 264,803 6/1982 Machida D8/99

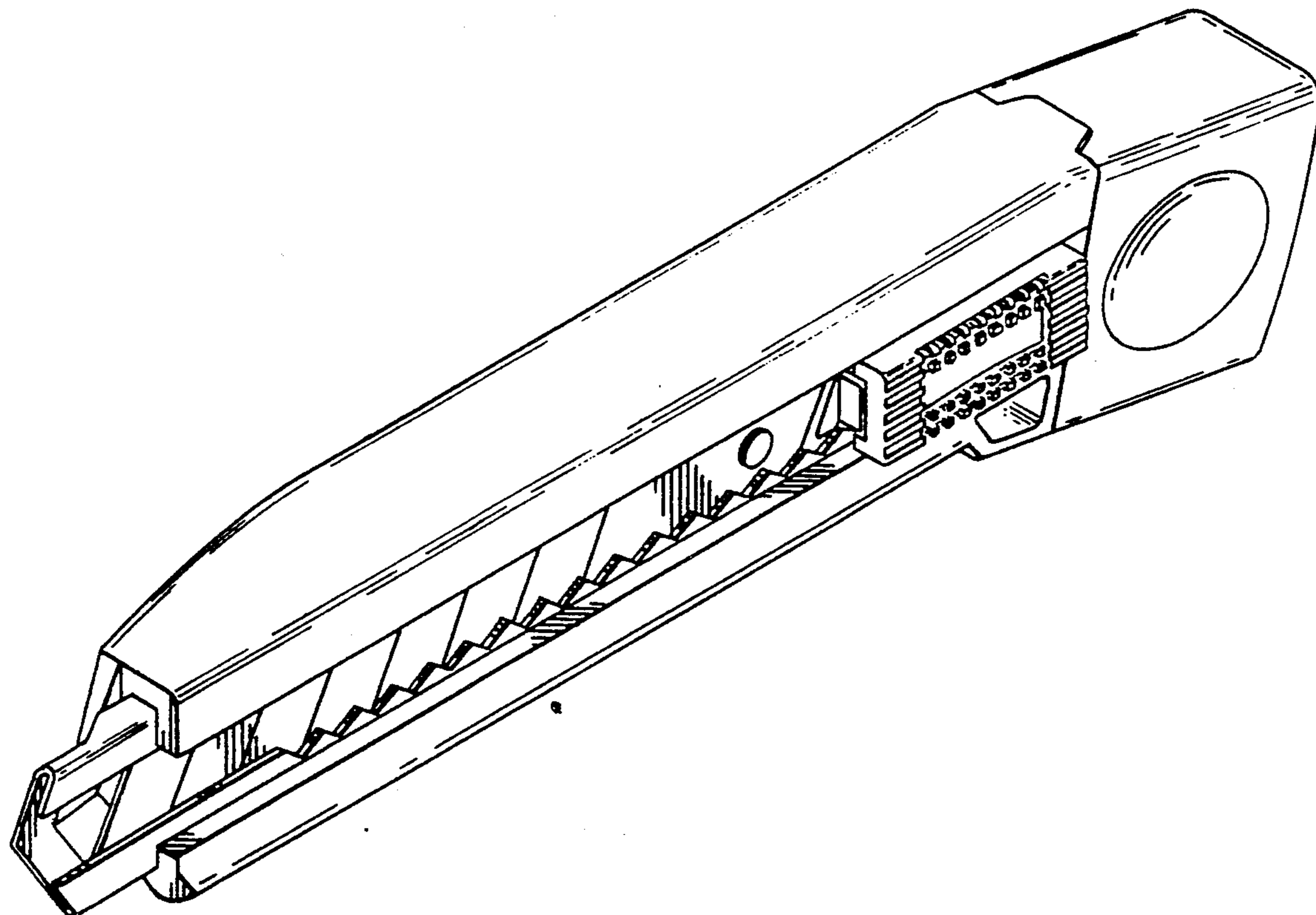

FIG. 1

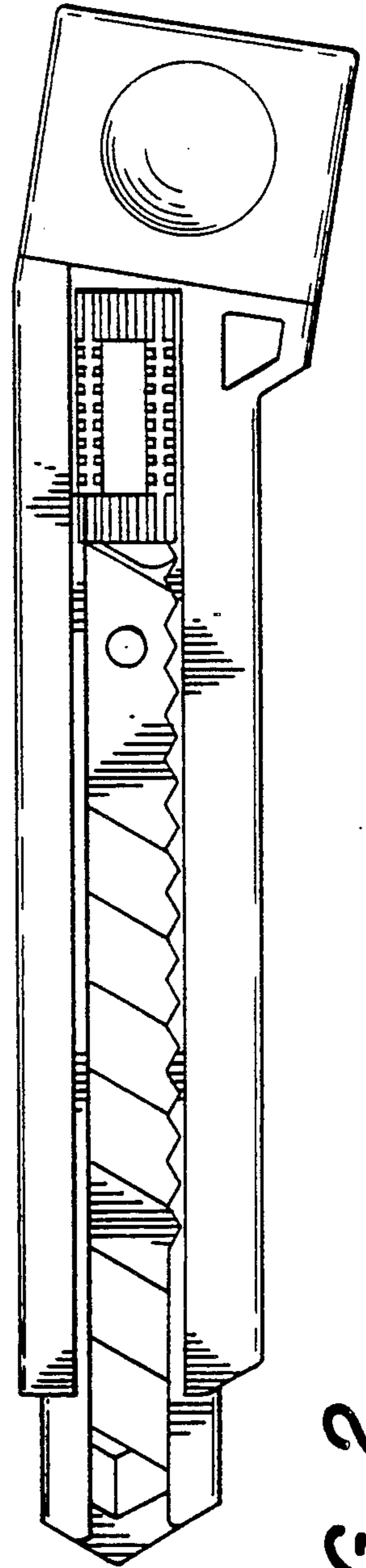
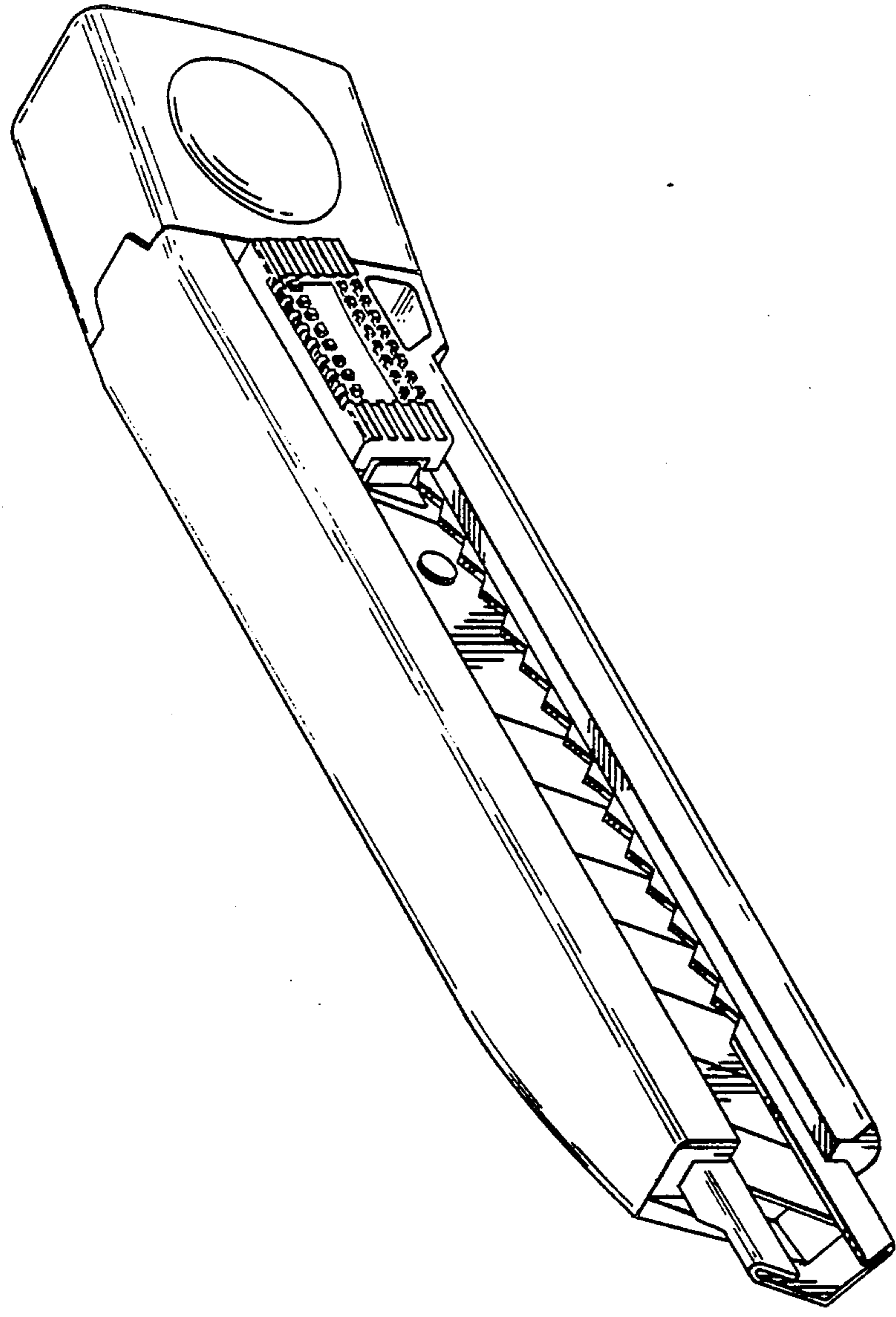

FIG. 2

FIG. 6

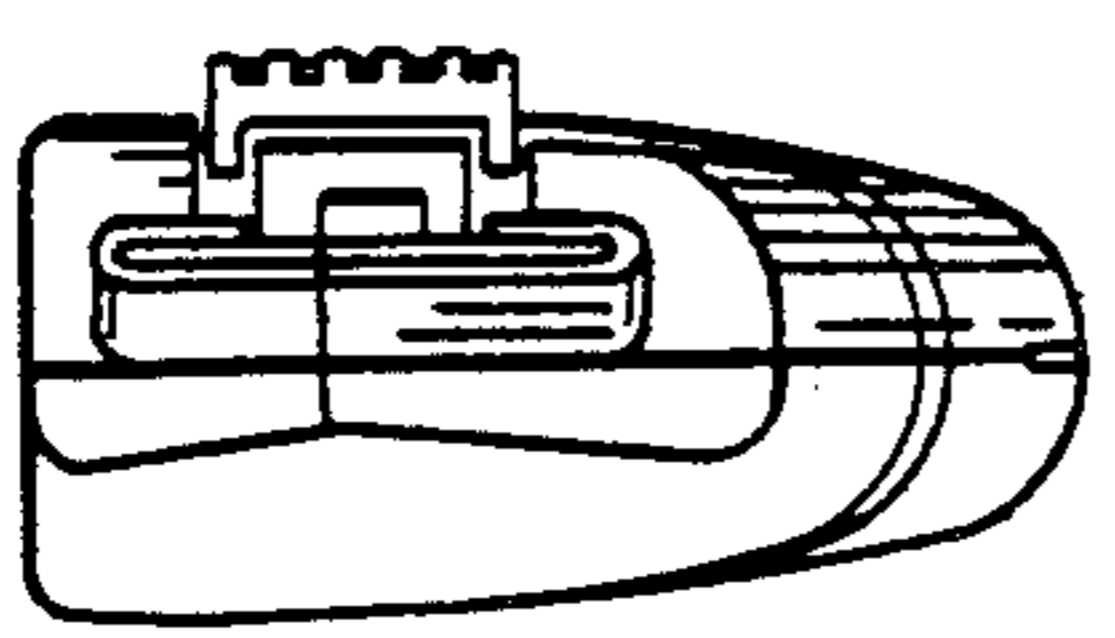

FIG. 3

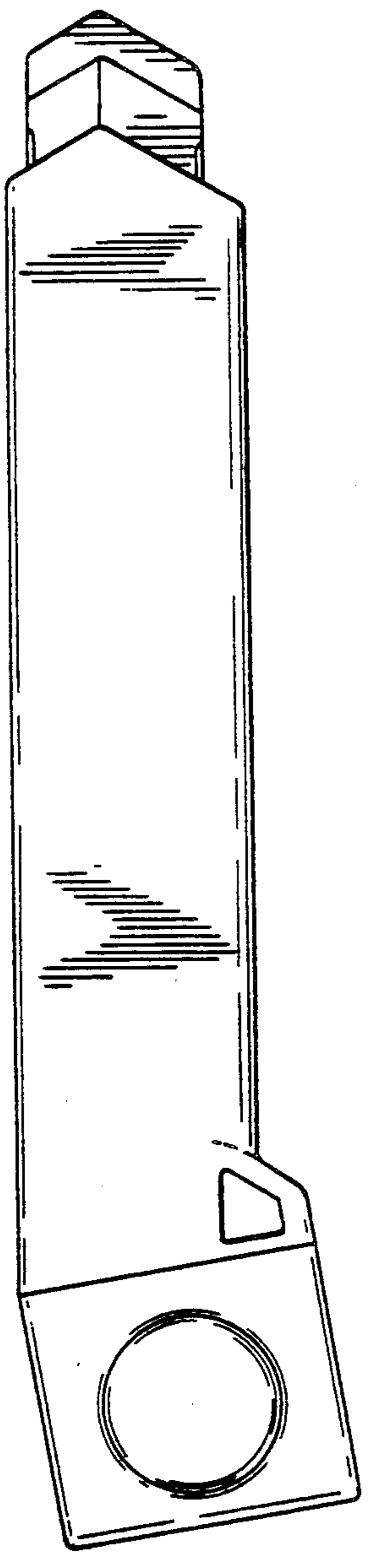

FIG. 4

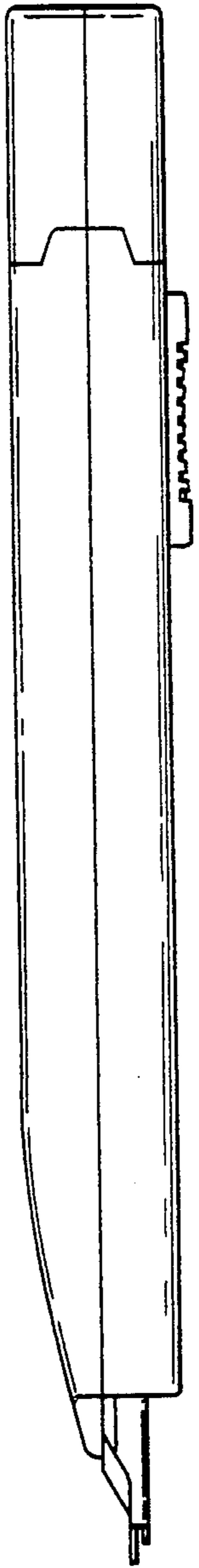

FIG. 7

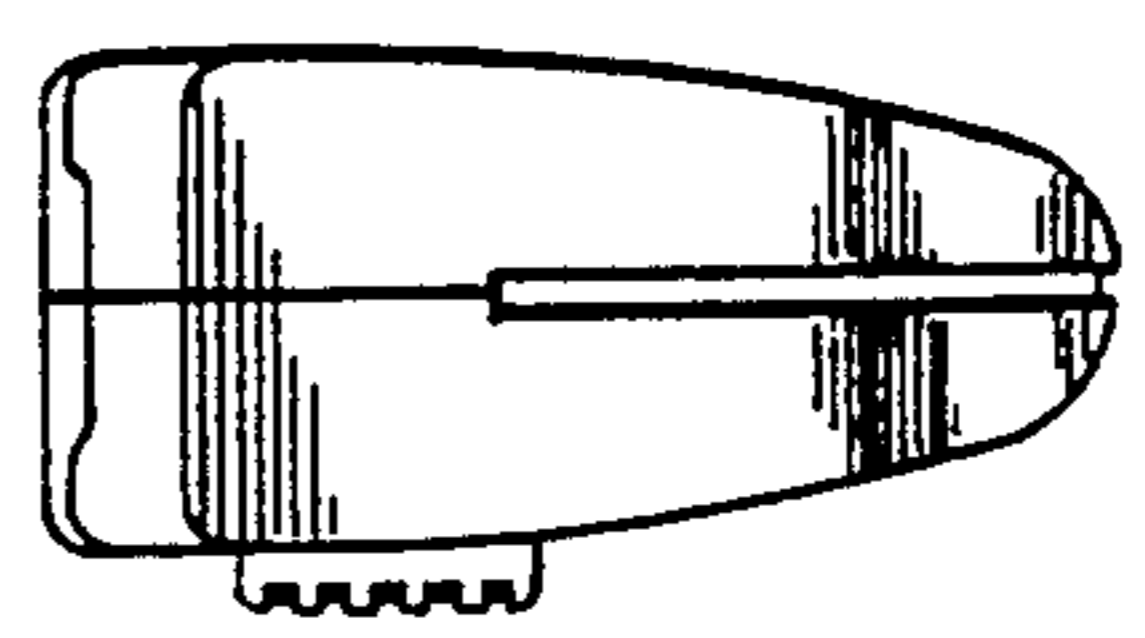
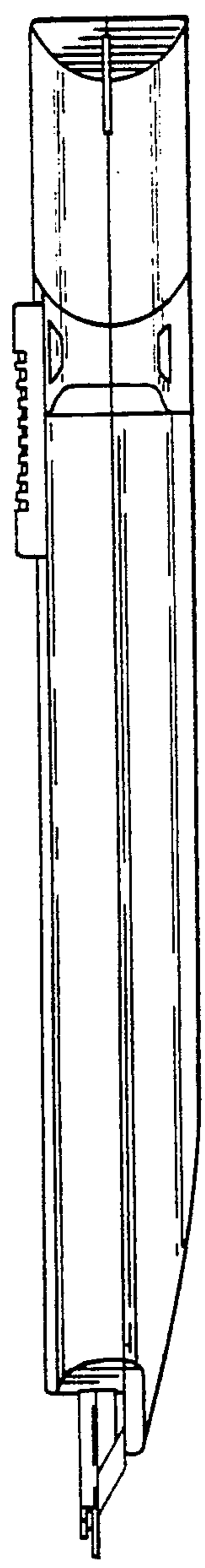

FIG. 5



UNITED STATES PATENT AND TRADEMARK OFFICE
CERTIFICATE OF CORRECTION

PATENT NO. : D324,475
DATED : March 10, 1992
INVENTOR(S) : Robert B. Staubitz, et al

It is certified that error appears in the above-identified patent and that said Letters Patent is hereby corrected as shown below:

In the Notice in the heading of column 1,
On the title page, "Aug. 10, 2007" should
read --Aug. 10, 2004--.

Signed and Sealed this
Fourth Day of May, 1993

Attest:



MICHAEL K. KIRK

Attesting Officer

Acting Commissioner of Patents and Trademarks