



US00D324379S

# United States Patent [19]

[11] Patent Number: Des. 324,379

Izaki

[45] Date of Patent: \*\* Mar. 3, 1992

## [54] ELECTRONIC COMPUTER

[75] Inventor: Kenzo Izaki, Chiba, Japan

[73] Assignee: Kabushiki Kaisha Toshiba, Kanagawa, Japan

[\*\*] Term: 14 Years

[21] Appl. No.: 446,710

[22] Filed: Dec. 6, 1989

## [30] Foreign Application Priority Data

Jun. 6, 1989 [JP] Japan ..... 1-20668

[52] U.S. Cl. .... D14/106

[58] Field of Search ..... D14/100, 101, 105, 106, D14/113, 115; D18/1, 4, 7, 11, 12; 340/700, 706, 711, 712; 341/22, 23; 364/706-708; 312/208; 235/145 A, 145 R; 358/248, 249; 400/690, 690.1, 691, 680, 681, 682, 685, 693

## [56] References Cited

### U.S. PATENT DOCUMENTS

- D. 224,784 7/1972 Sucre et al. .... D26/5
- D. 254,005 1/1980 Zadock et al. .... D14/106
- D. 275,102 8/1984 MacConnel ..... D14/106
- D. 280,511 9/1985 Moggridge et al. .... D14/106
- D. 280,622 9/1985 Moggridge et al. .... D14/100
- D. 282,843 3/1986 Kurihara et al. .... D14/100
- D. 283,511 4/1986 Dunn ..... D14/106
- D. 284,193 6/1986 Marshall ..... D14/101
- D. 284,474 7/1986 Sawada ..... D14/100
- D. 287,969 1/1987 Kusanagi ..... D14/106
- D. 288,566 3/1987 Chin et al. .... D14/106
- D. 289,177 4/1987 Sawada ..... D18/7
- D. 289,763 5/1987 Fujii et al. .... D14/106
- D. 290,256 6/1987 Sapper et al. .... D14/106
- D. 290,845 7/1987 Yubisui et al. .... D14/111
- D. 291,442 8/1987 Kurihara ..... D14/106
- D. 293,677 1/1988 Hara et al. .... D14/106
- D. 293,678 1/1988 Sawatani et al. .... D14/106
- D. 294,029 2/1988 Nishiyama et al. .... D14/106
- D. 294,831 3/1988 Hara et al. .... D14/106
- D. 295,176 4/1988 Nishimoto et al. .... D14/106
- D. 295,519 3/1988 Kimble ..... D14/106
- 299,031 12/1988 Sugano ..... D14/106
- D. 308,860 6/1990 Tsukada et al. .... D14/106
- D. 308,861 6/1990 Tsukada et al. .... D14/106
- D. 312,822 12/1990 Watabe et al. .... D14/106

## FOREIGN PATENT DOCUMENTS

- 100708 6/1988 China .
- 100709 6/1988 China .
- 101093 7/1988 China .
- 8800660 10/1988 Fed. Rep. of Germany .
- 47-14961 5/1972 Japan .
- 499866 4/1979 Japan .
- 639216 11/1984 Japan .
- 650470 5/1985 Japan .
- 664175 10/1985 Japan .
- 85300416 5/1986 Japan .
- 684172 8/1986 Japan .
- 684172 8/1986 Japan .
- 685000 8/1986 Japan .
- 685063 8/1986 Japan .
- 685121 8/1986 Japan .
- 685542 8/1986 Japan .
- 686374 9/1986 Japan .
- 686381 9/1986 Japan .
- 686386 9/1986 Japan .
- 686658 9/1986 Japan .
- 686706 9/1986 Japan .
- 685000 12/1986 Japan .
- 695931 12/1986 Japan .
- 696188 1/1987 Japan .
- 697328 1/1987 Japan .
- 763838 6/1988 Japan .
- 685121 10/1988 Japan .
- 747990 11/1988 Japan .
- 748513 11/1988 Japan .
- 749802 11/1988 Japan .
- 746985 4/1989 Japan .
- 746985 4/1989 Japan .
- 763840 6/1989 Japan .
- 763855 6/1989 Japan .
- 67297 2/1987 Rep. of Korea .
- 85032 10/1988 Rep. of Korea .
- 92859 7/1989 Rep. of Korea .
- 92863 7/1989 Rep. of Korea .
- 852546 1/1987 Sweden .
- 852547 1/1987 Sweden .
- 105573 11/1988 Taiwan .
- 107394 1/1989 Taiwan .

## OTHER PUBLICATIONS

- Chaplet Halikan LA-22, 4/21/89.
- Sharp AX286L, 9/29/88.
- NEC PC-9801 LX5C, 8/23/88.
- Sharp Advertisement, 05/19/76.



- Fanuc System P-Model, 07/27/83.  
 Moebel Interior Design, 01/05/84.  
 The Office 98-6, 01/31/84.  
 Demus 645, 02/22/84.  
 MRD Advertisement, 03/29/84.  
 Gavilan Mobile Computer Brochure, 04/19/84.  
 Picture #J9016870, 05/08/84.  
 Hewlett Packard Advertisement, 05/18/84.  
 Hewlett Packard Advertisement, 06/05/84.  
 Epson HC-88, 07/01/84.  
 Hitachi Advertisement, 09/04/84.  
 Hewlett Packard Advertisement, 09/12/84.  
 Sharp PC-5000 Brochure, 09/26/84.  
 Data General One Advertisement, 09/28/84.  
 Apple Computer Apple IIC, 10/15/84.  
 TI Software Journal, Pro-Lite TM, 11/14/84.  
 IS-11c Advertisement, 11/14/84.  
 Hewlett-Packard Portable Plus, 12/00/85.  
 FLM-700, 01/31/86.  
 Fujitsu FM-16, 05/21/86.  
 PC-816F Advertisement, 05/27/86.  
 Zenith Data Systems NEWSDATE Newsletter, 06/07/86.  
 Tandy 600 Advertisement, 07/25/86.  
 Ricoh JP70D Brochure, 09/29/86.  
 Data General One Brochure, 10/03/86.  
 Article re IBM Portable Personal Computer, 10/15/86.  
 NEC PC-98LT Advertisement, 10/23/86.  
 Yaskawa P-t50 Advertisement, 11/12/86.  
 Yaskawa Memocon®-SC GL20 Advertisement, 03/27/87.  
 TI Advertisement in Telephony, 04/01/87.  
 Data General One Model 2J Brochure, 05/20/87.  
 Hitachi B16LX Brochure, 08/31/87.  
 Ricoh Brochure, 09/17/87.  
 Sony Produce 100 Brochure, 09/18/87.  
 Panasonic FW-U1EX Advertisement, 10/02/87.  
 Nihon IBM 55 Model 5535, 10/19/87.  
 NEC Minitel 5 Advertisement, 10/29/87.  
 Rein Laptop 300 SLC Advertisement, 10/29/87.  
 IBM 5540/5535 Brochure, 11/04/87.  
 NEC PC-9800 Advertisement, 11/27/87.  
 Panasonic U1EX Advertisement, 12/08/87.  
 Schneider Multivision 300 SLC Catalog, 00/00/88.  
 Panasonic U1Pro, 01/04/88.  
 Diagnostic Products Review, 01/02/88.  
 Toshiba E & E News, 02/26/88.  
 Seiko-Epson PC-286L, 03/02/88.  
 Toshiba JW90FII Rupo Brochure, 03/03/88.  
 Hitachi B16LX Brochure, 04/05/88.  
 Sony Produce PJ-100EX Brochure, 04/05/88.  
 WS Japanese Advertisement, 04/27/88.  
 NEC Multispeed, Spring '88.  
 Samsung S5200, 05/10/88.  
 Datavue Snap 1+1, 05/10/88.  
 Portable Computer Review, p. 32, 05/10/88.  
 GridCase 1530 Advertisement, 05/10/88.  
 NEC MultiSpeed EL Model 2 Brochure, 05/10/88.  
 Sharp PC-5000 Brochure, 05/12/88.  
 Japanese Advertisement, 05/12/88.  
 Sanyo ES 100, 05/13/88.  
 NEC PC-9801 LV 21 Brochure, 05/13/88.  
 Sharp WV-500, 05/19/88.  
 Panafacom C-250 LT Brochure, 05/19/88.  
 Sony Produce 100EX Advertisement, 05/19/88.  
 Panasonic Panacom 6000 LT Brochure, 06/07/88.  
 NEC Mini 5 Carryword Brochure, 06/27/88.  
 Ricoh JP90LX Brochure, 06/28/88.  
 NEC Mini 5 HL Brochure, 06/30/88.  
 NEC PC-98 LT Brochure, 07/14/88.  
 Kyosera 386AX, 09/00/88.  
 NEC PC-9801, 10/26/88.  
 Sanyo MBC-17LTJ, 10/00/88.  
 Toshiba T 1600, 11/00/88.  
 Sanyo MBC 17LTJH, 11/28/88.  
 Oki "IF 386 AX", 12/09/88.  
 Kyosera 386-SX Laptop AX, 01/10/89.  
 Seiko-Epson PC-286LS, 02/16/89.  
 NEC PC-9801 LV21, 05/13/89.  
 Fujitsu G-150LT, 05/19/89.  
 Visual Computer Brochure.  
 Gavilan Mobile Computer Brochure.  
 Olivetti Personal Computer M15 Brochure.  
 Epson HC-88, HC80 Brochure.  
 Epson PX-8 Personal Computer Brochure.  
 Mitsubishi mp286L Laptop Personal Computer Brochure.  
 Grid Brochure.  
 Dauphin Laptop Computer Brochure.  
 MicroDIRECT Brochure.  
 SuperSport Brochure.  
 Panasonic KX-D4930 Advertisement.

Ampere WS-1 Advertisement.  
NEC Contrast.  
NEC Starlet PC-8401A Advertisement.  
Victor Technologies, V 286 P Catalog.

*Primary Examiner*—Wallace R. Burke  
*Assistant Examiner*—Freda S. Nunn  
*Attorney, Agent, or Firm*—Banner, Birch, McKie & Beckett

[57]

**CLAIM**

The ornamental design for an electronic computer, as shown and described.

**DESCRIPTION**

FIG. 1 is a top, front and left side perspective view of an electronic computer showing my new design;  
FIG. 2 is a front elevational view thereof;  
FIG. 3 is a rear elevational view thereof;  
FIG. 4 is a top plan view thereof;  
FIG. 5 is a right side elevational view thereof;  
FIG. 6 is a left side elevational view thereof;  
FIG. 7 is a bottom plan view thereof;  
FIG. 8 is a top, front and right side perspective view thereof showing the display panel and keyboard in closed position.

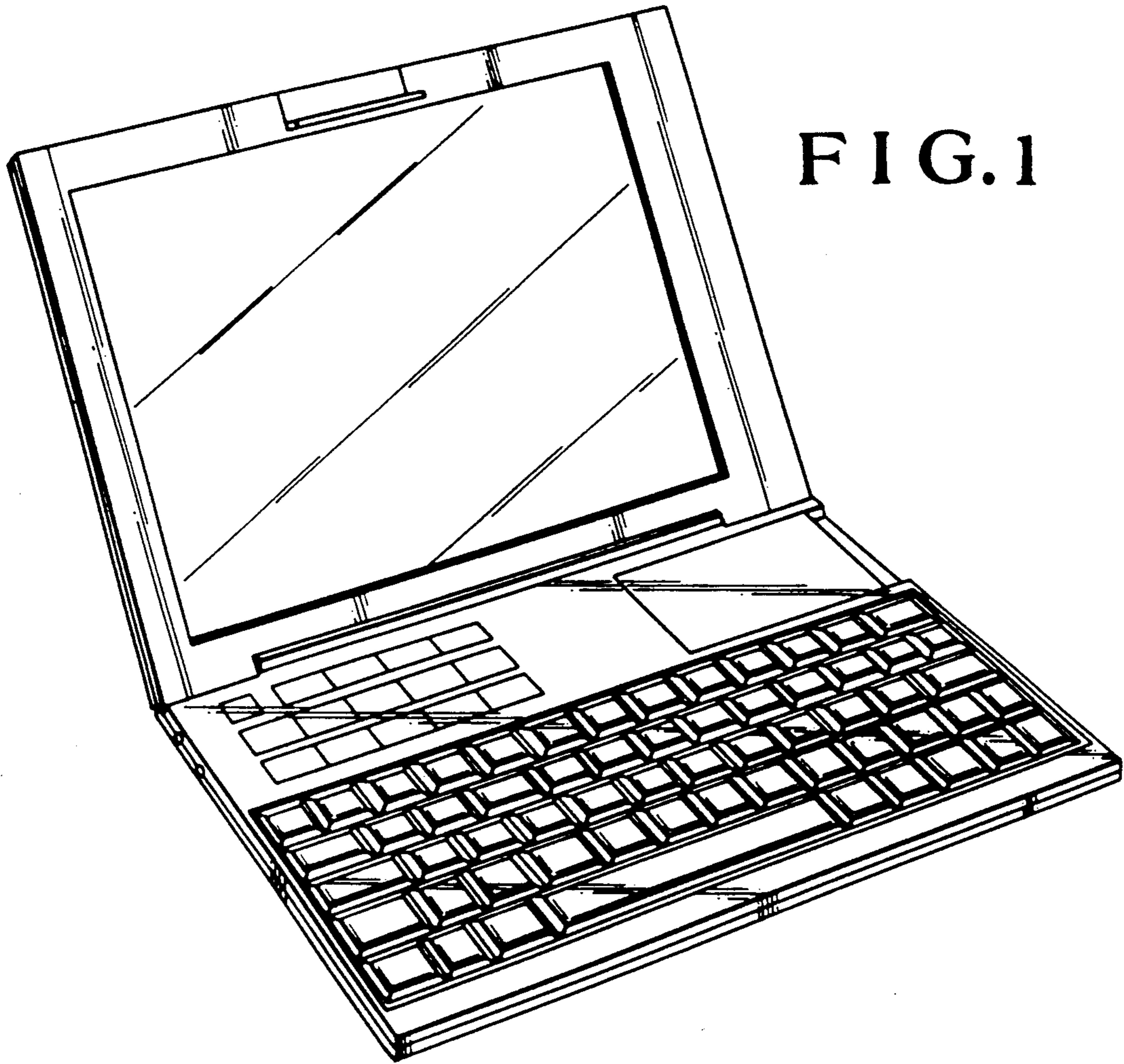

FIG. 1

FIG. 2

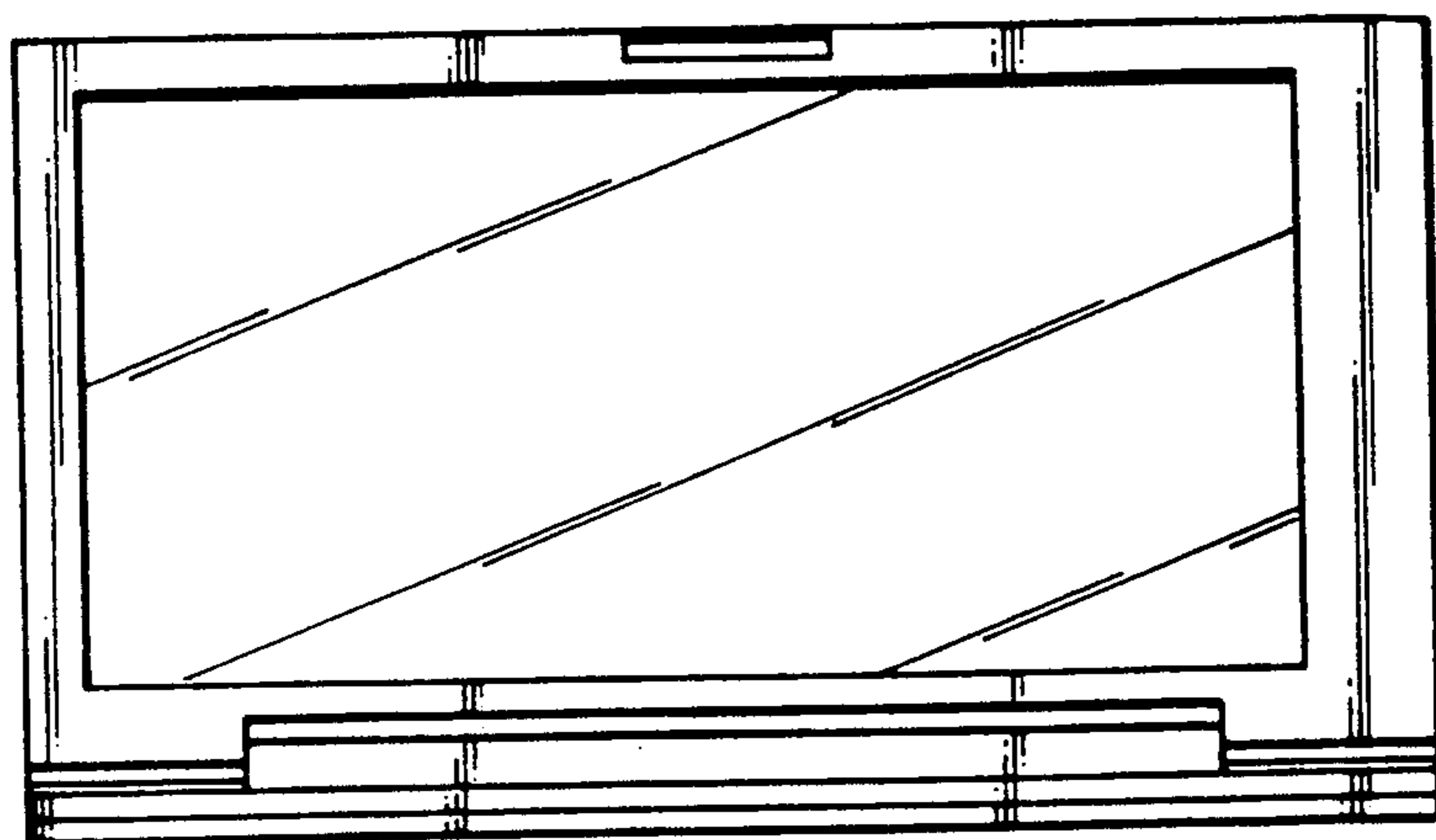

FIG.3

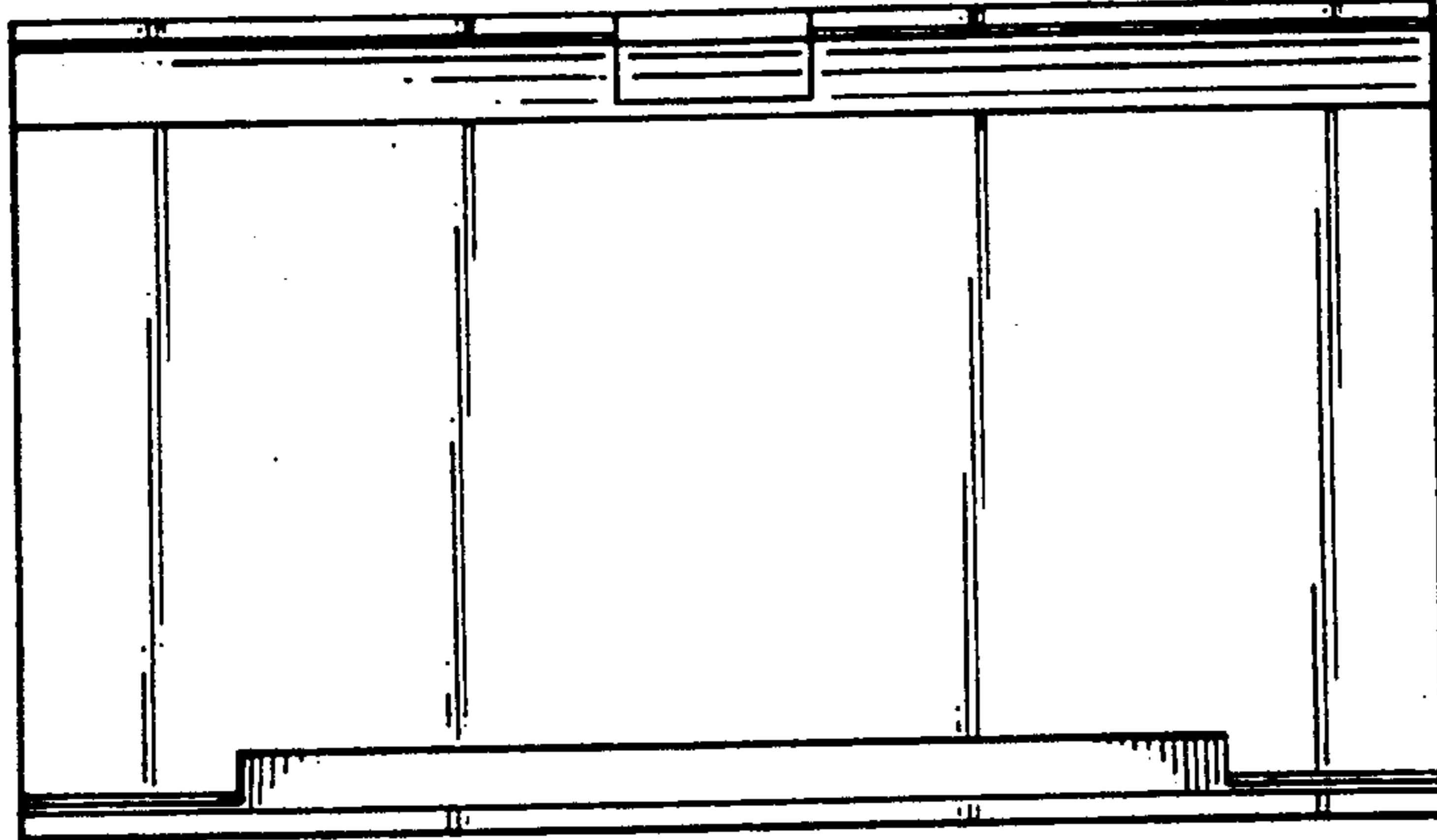

FIG.4

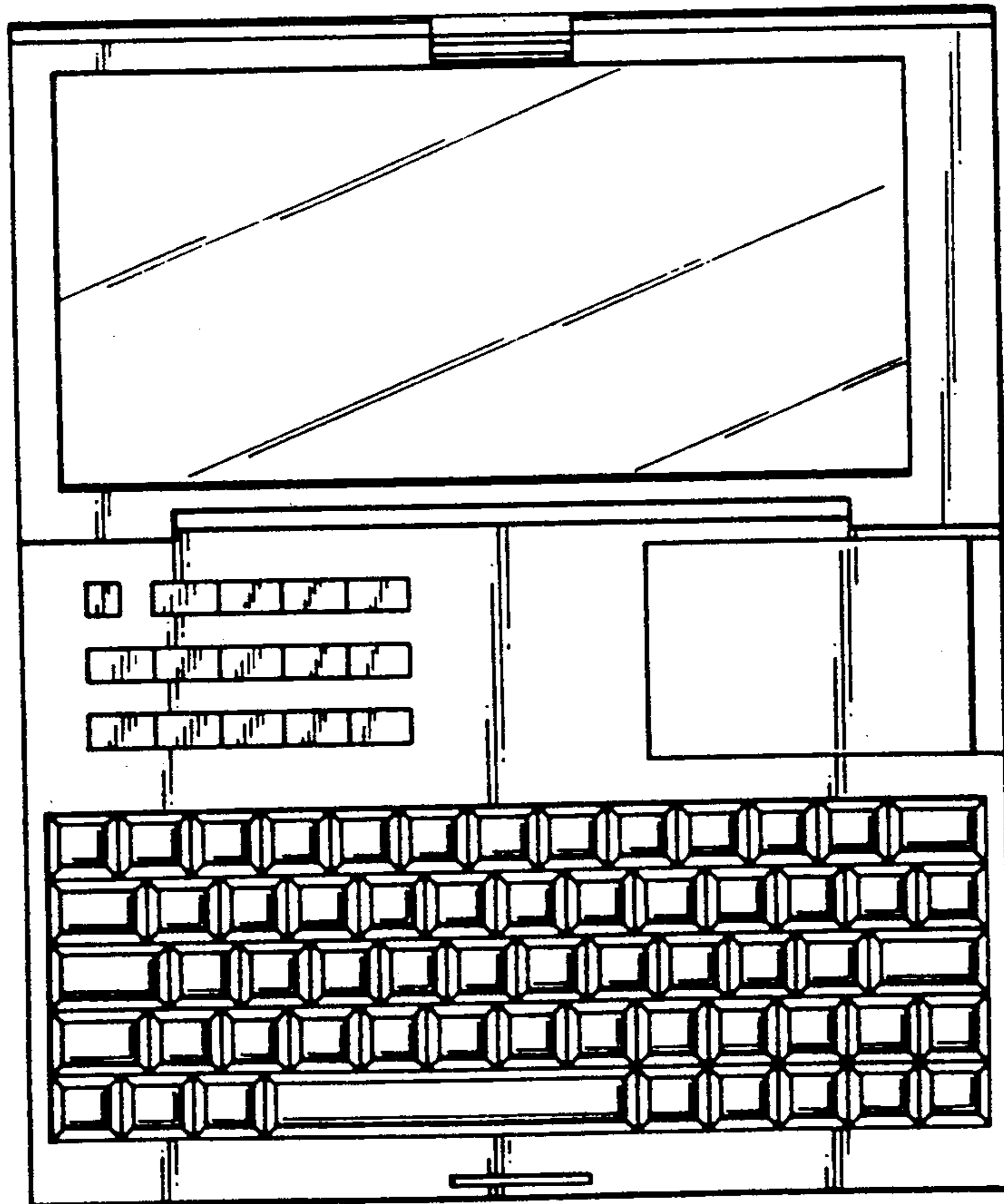

FIG.5

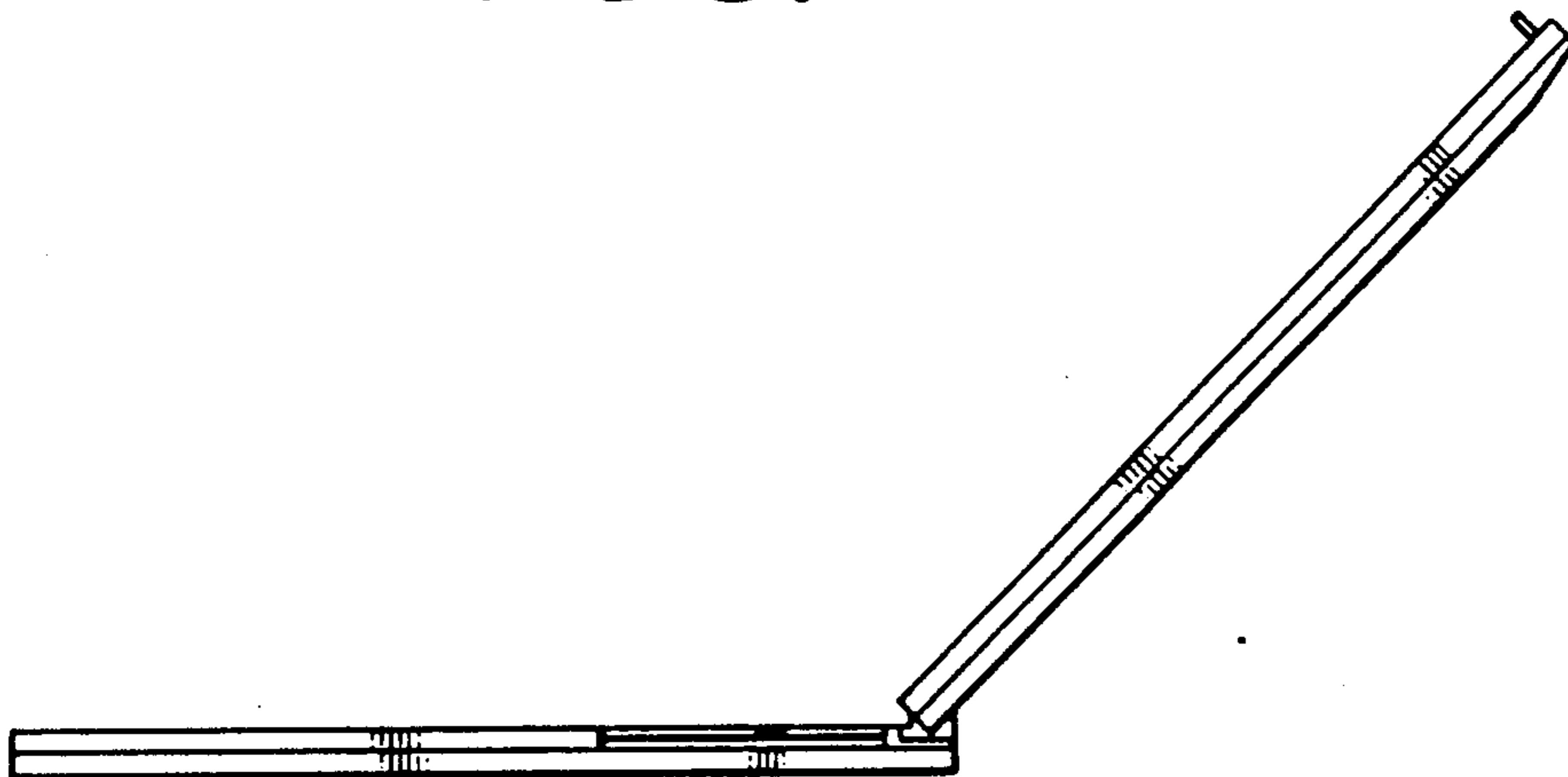

FIG.6

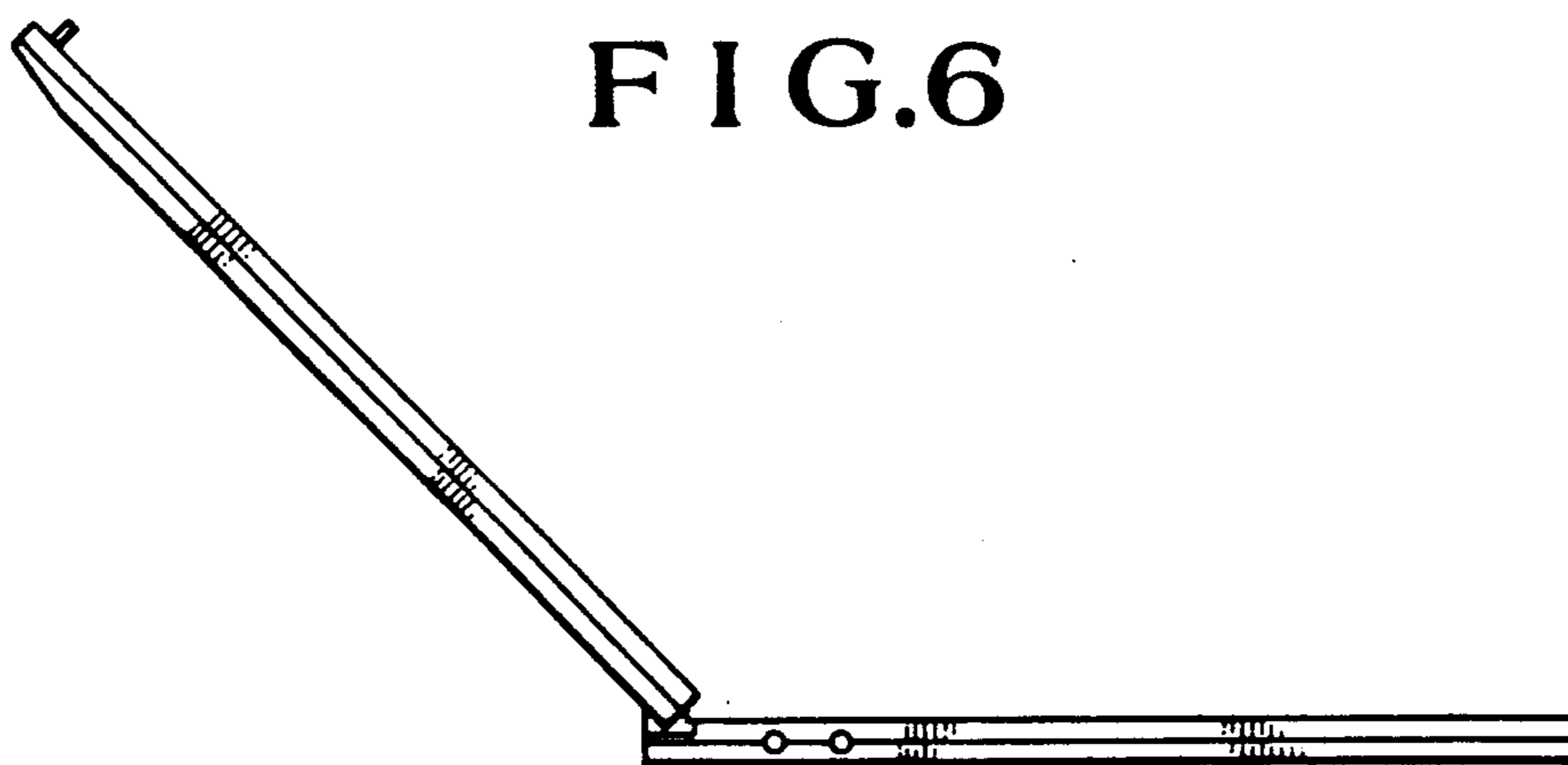

FIG.7

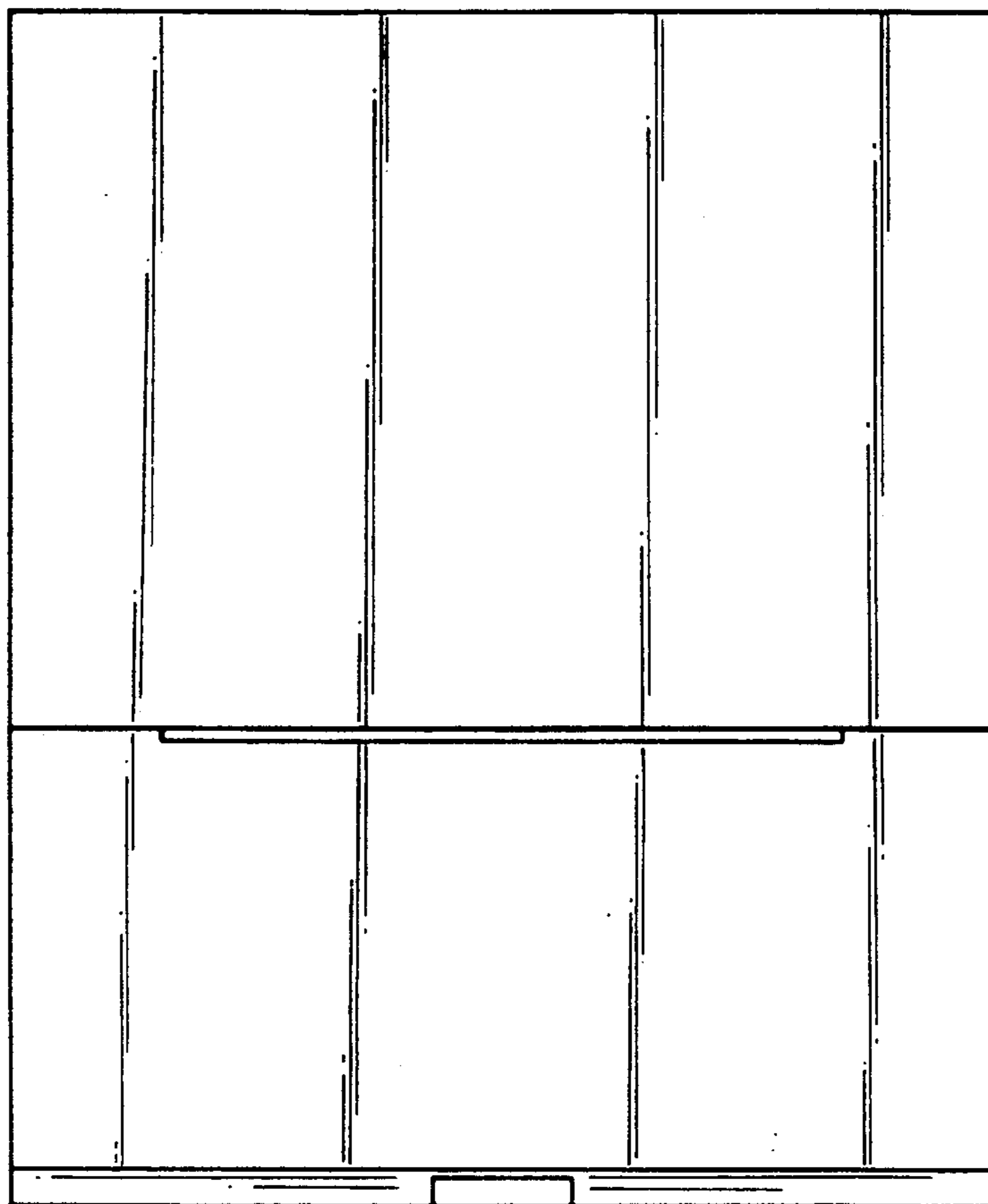

FIG.8

