



US00D324276S

United States Patent [19]

[11] Patent Number: **Des. 324,276**

Bradley

[45] Date of Patent: **** Feb. 25, 1992**

[54] **WATER ASHTRAY**

2,779,624 1/1957 Friedman 131/231

[76] Inventor: **Nellie C. Bradley**, 517 Reid School Rd., Taylors, S.C. 29687

Primary Examiner—Wallace R. Burke

Assistant Examiner—H. Baynham

Attorney, Agent, or Firm—Leon Gilden

[**] Term: **14 Years**

[57] **CLAIM**

[21] Appl. No.: **501,188**

The ornamental design for a water ashtray, as shown and described.

[22] Filed: **Mar. 29, 1990**

[52] U.S. Cl. **D27/106**

[58] Field of Search **D27/106, 115, 121, 110; 131/231, 174**

DESCRIPTION

FIG. 1 is a front elevational view of the water ashtray showing my new design;

FIG. 2 is a rear elevational view thereof;

FIG. 3 is a left side elevational view thereof;

FIG. 4 is a right side elevational view thereof;

FIG. 5 is a top plan view thereof;

FIG. 6 is a bottom plan view thereof; and

FIG. 7 is a perspective view thereof.

[56] References Cited

U.S. PATENT DOCUMENTS

- | | | | | |
|------------|---------|----------|-------|---------|
| D. 87,647 | 8/1932 | Scarponi | | D27/110 |
| D. 168,130 | 11/1952 | Stirratt | | D27/121 |
| D. 183,157 | 7/1958 | Anderson | | D27/110 |

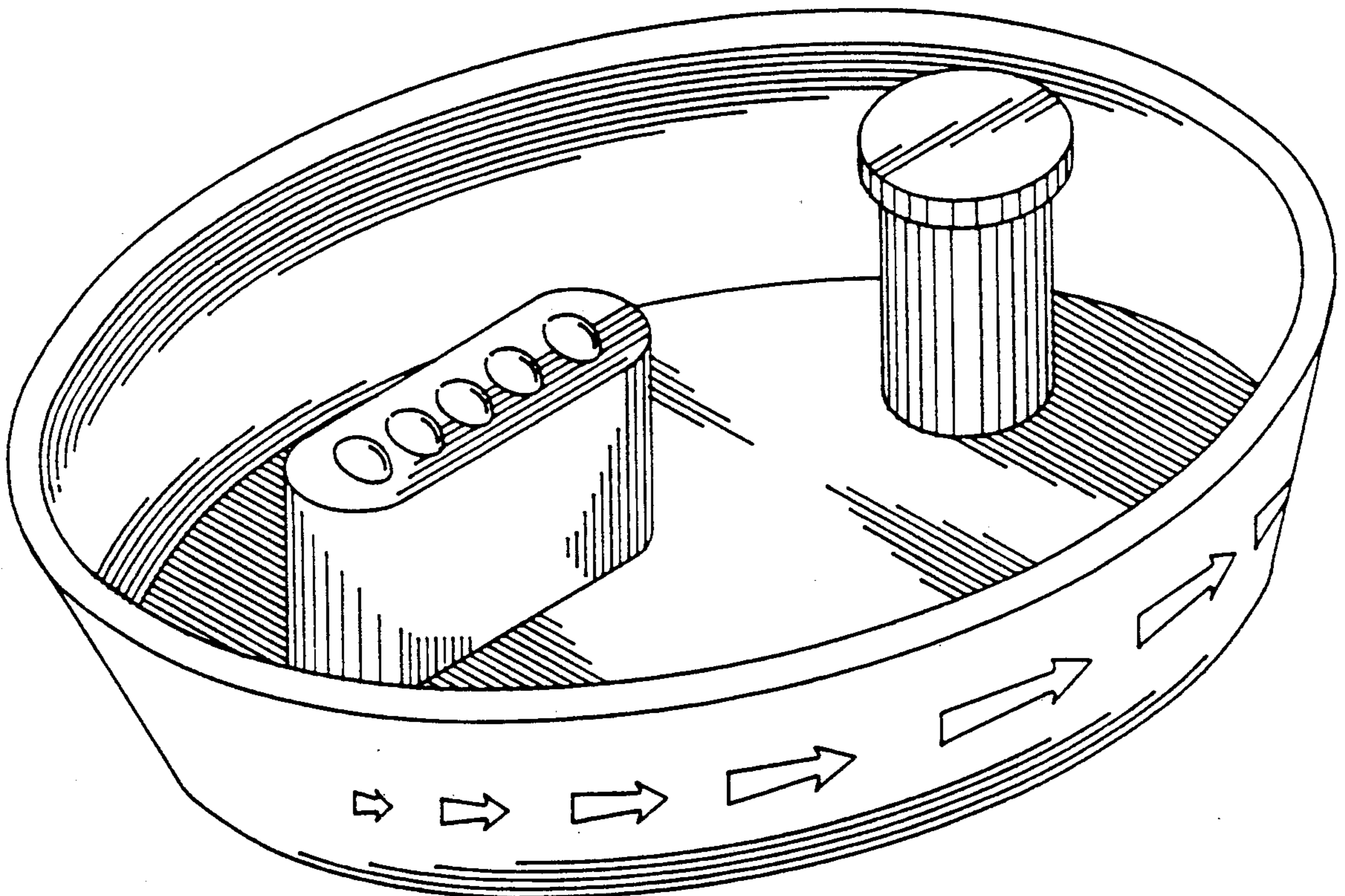

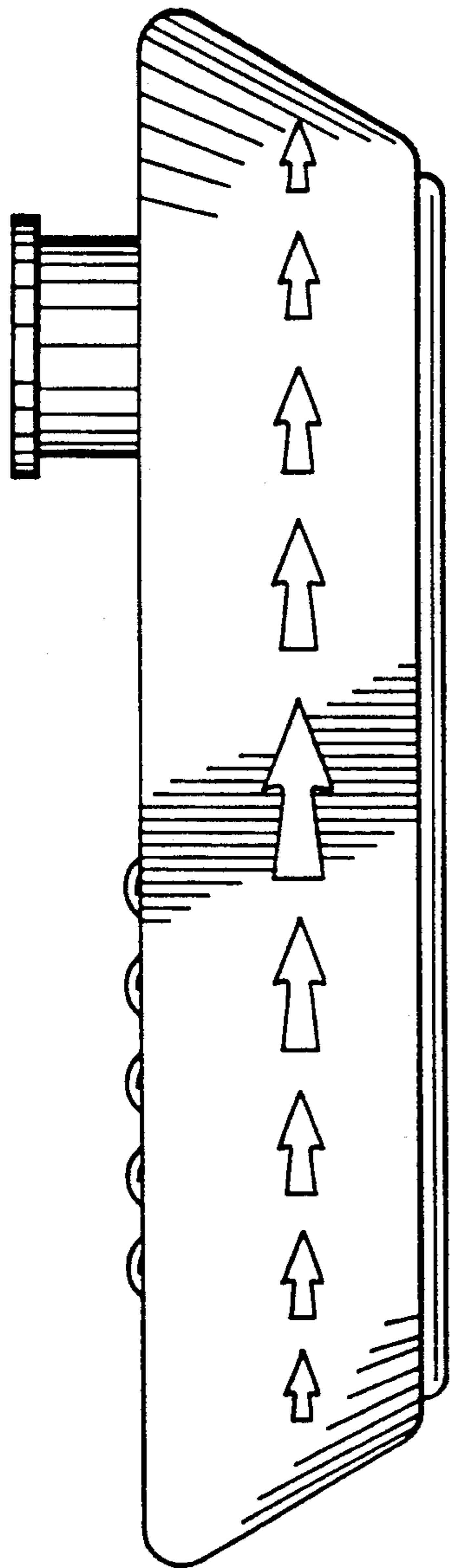

Fig. 1

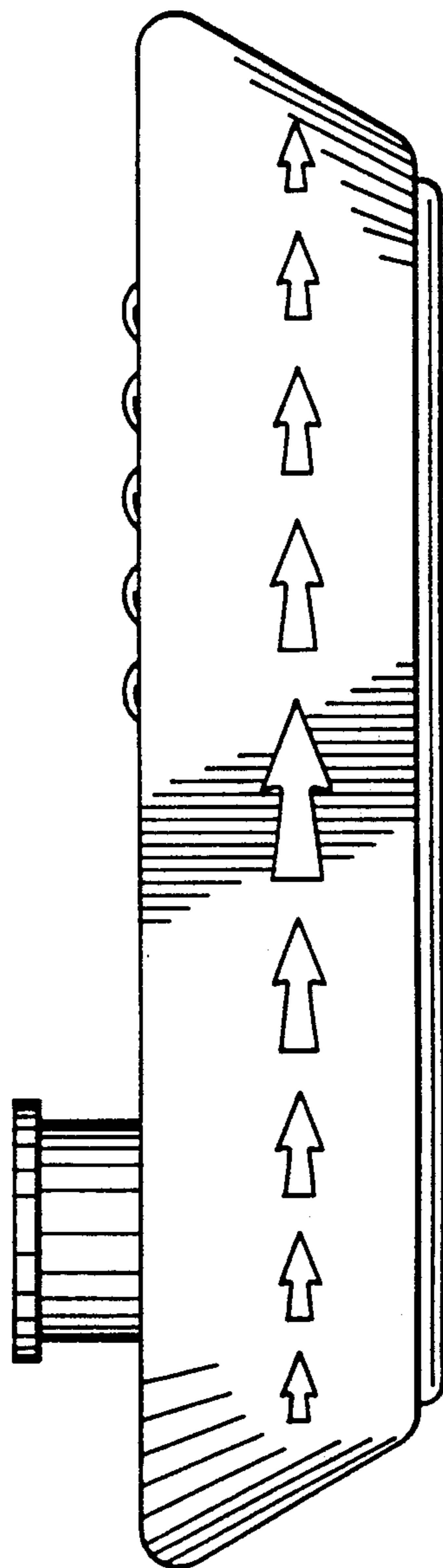

Fig. 2

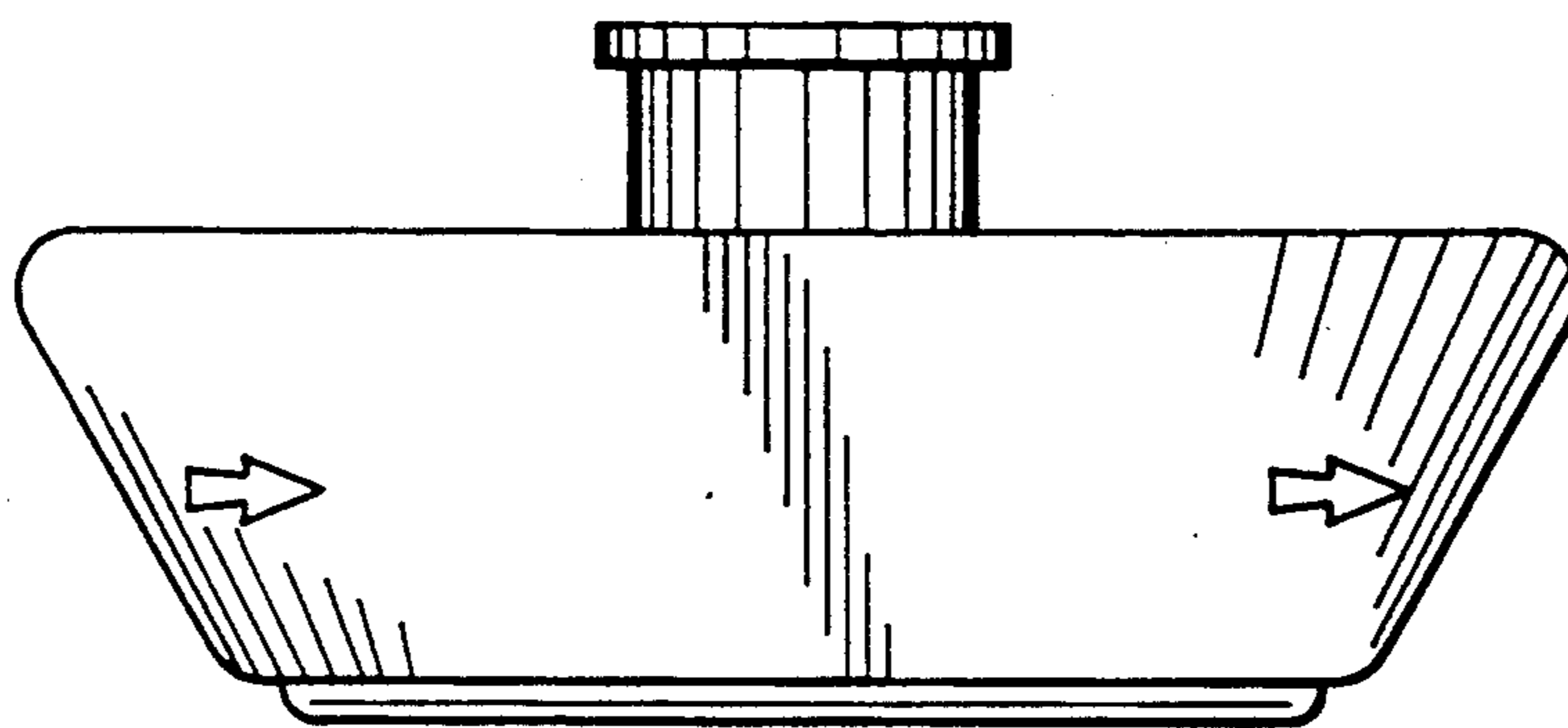

FIG. 3

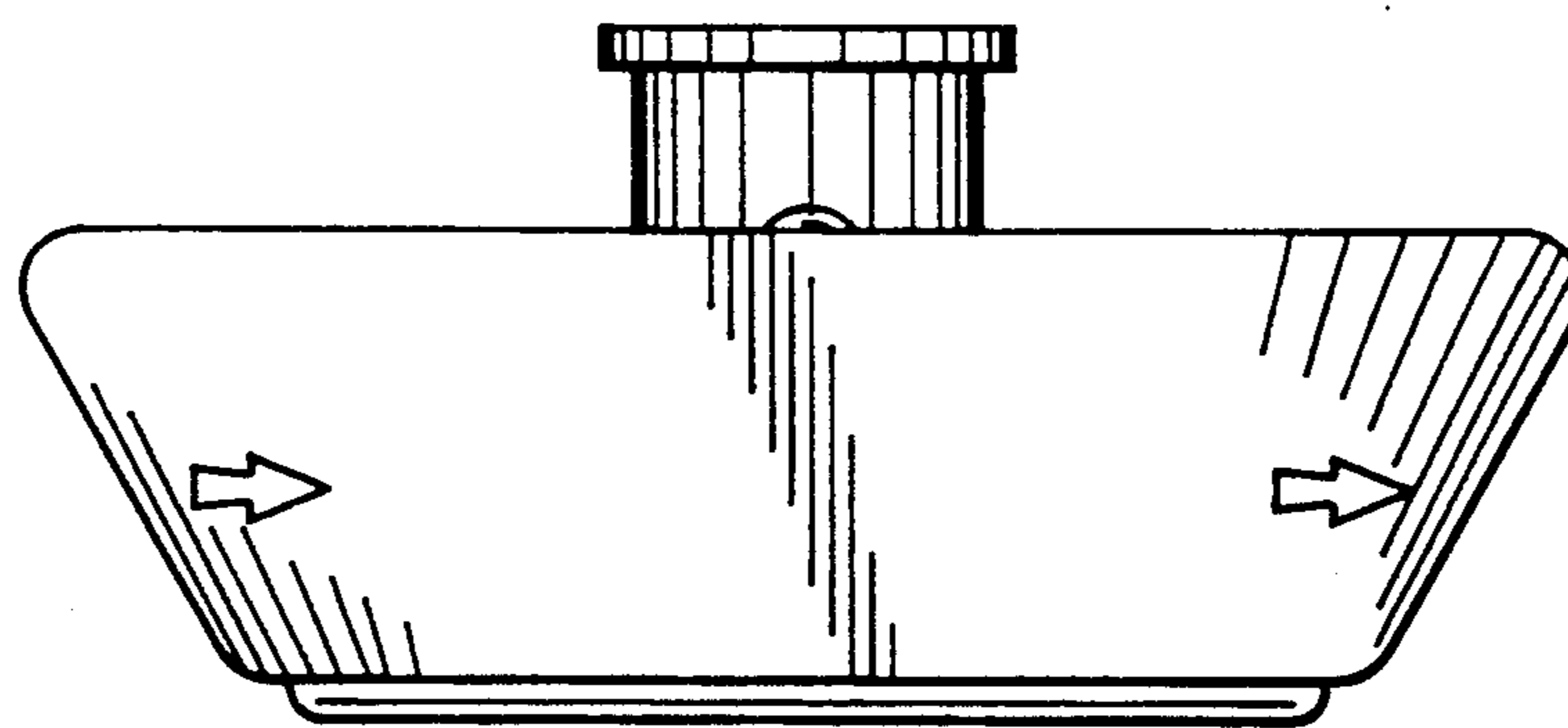

FIG. 4

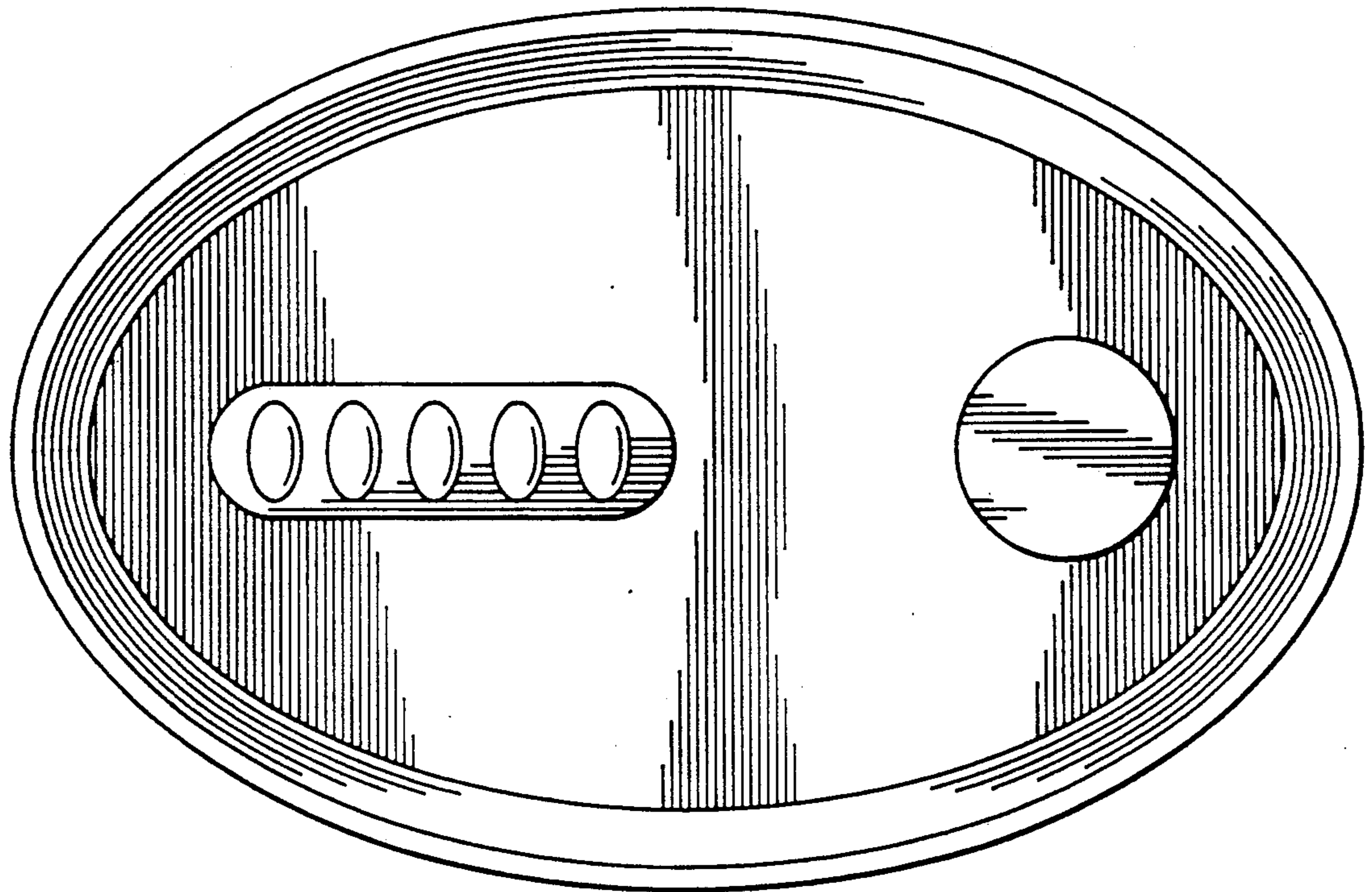

Fig. 5

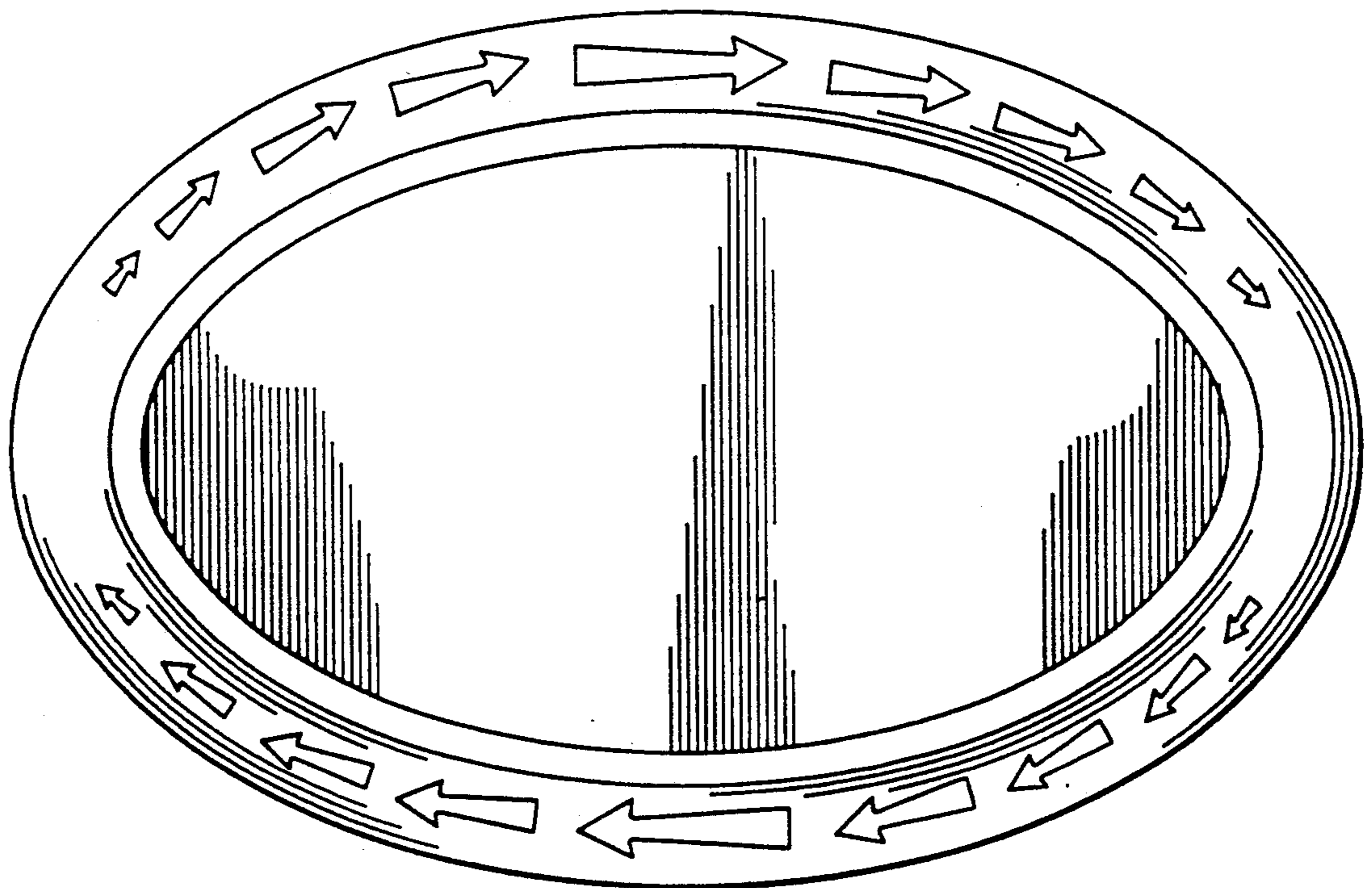

Fig. 6

