



US00D324159S

United States Patent [19]

[11] Patent Number: **Des. 324,159**

Fujita et al.

[45] Date of Patent: **** Feb. 25, 1992**

[54] **PORTABLE CUT SAW**

3,360,021 12/1967 Mejia D8/64

[75] Inventors: **Teruyuki Fujita; Kenji Fukuda**, both of Osaka, Japan

Primary Examiner—Nelson C. Holtje
Assistant Examiner—J. H. Musgrove
Attorney, Agent, or Firm—Wenderoth, Lind & Ponack

[73] Assignee: **Nippon Pneumatic Manufacturing Co., Ltd.**, Osaka, Japan

[57] **CLAIM**

[**] Term: **14 Years**

The ornamental design for a portable cut saw, as shown.

[21] Appl. No.: **387,967**

DESCRIPTION

[22] Filed: **Aug. 1, 1989**

[52] U.S. Cl. **D8/64**

[58] Field of Search **D8/64; 30/378**

FIG. 1 is a right side elevational view of a portable cut saw showing our new design;
FIG. 2 is a left side elevational view;
FIG. 3 is a top plan view;
FIG. 4 is a rear elevational view;
FIG. 5 is a front elevational view;
FIG. 6 is a bottom plan view;
FIG. 7 is a bottom front left-side perspective view; and
FIG. 8 is a right side elevational view, the broken lines showing of the hose is for illustrative purposes only and forms no part of the claimed design.

[56] **References Cited**

U.S. PATENT DOCUMENTS

- D. 302,785 8/1989 Cunningham D8/64
- D. 308,469 6/1990 Fushiya et al. D8/64
- 3,016,932 1/1962 Jacobson D8/64

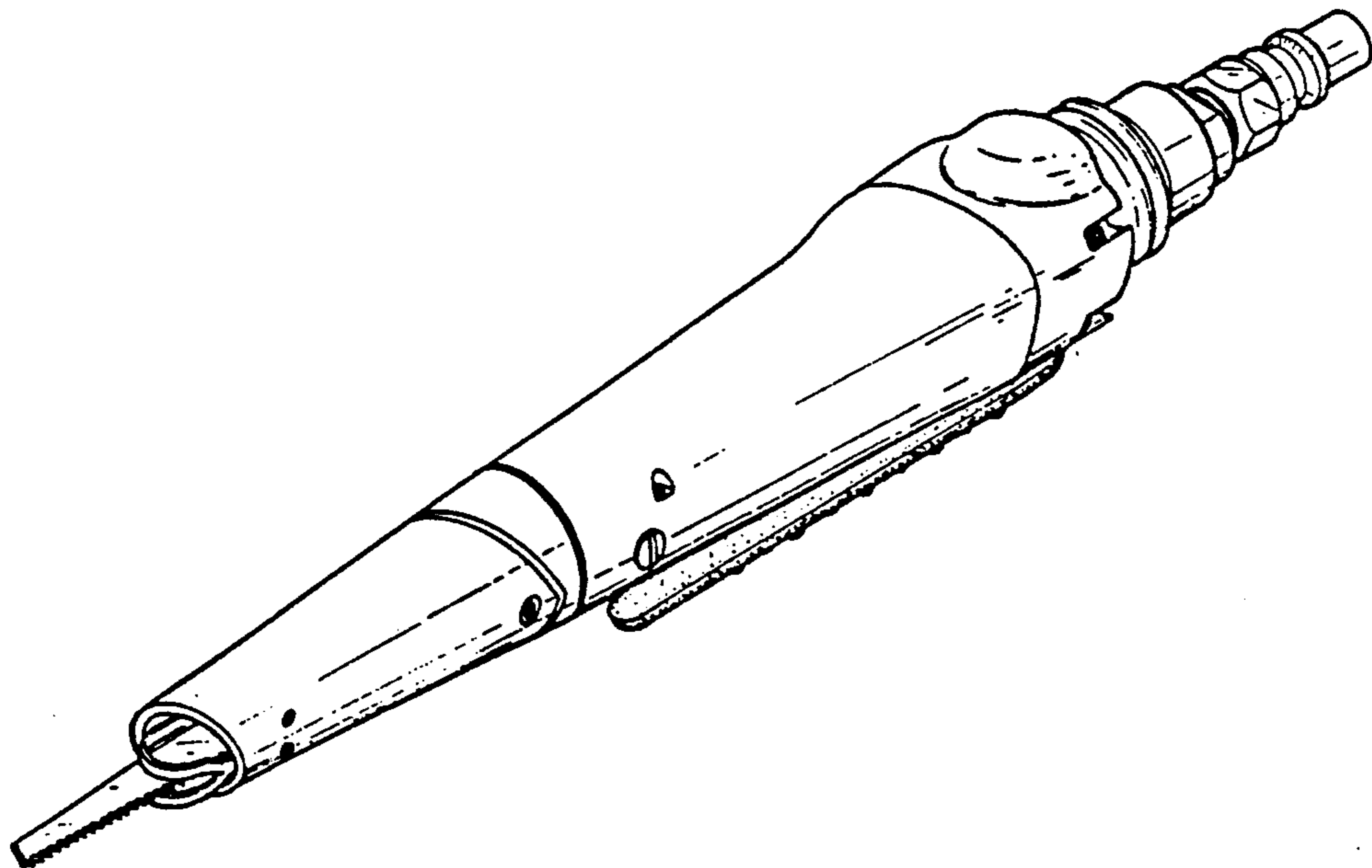

FIG. 1

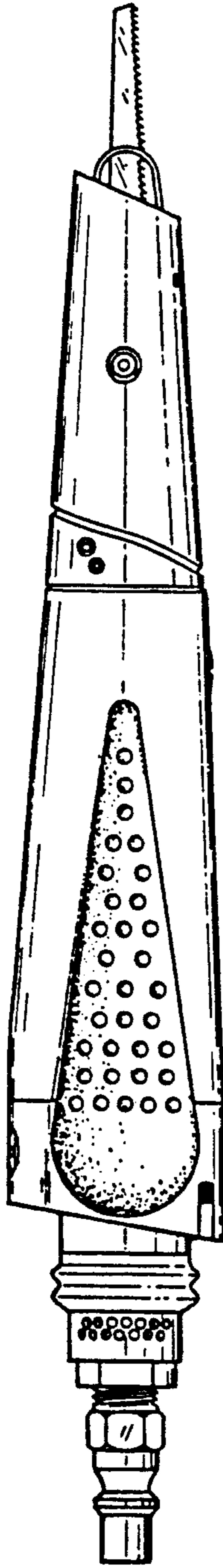

FIG. 2

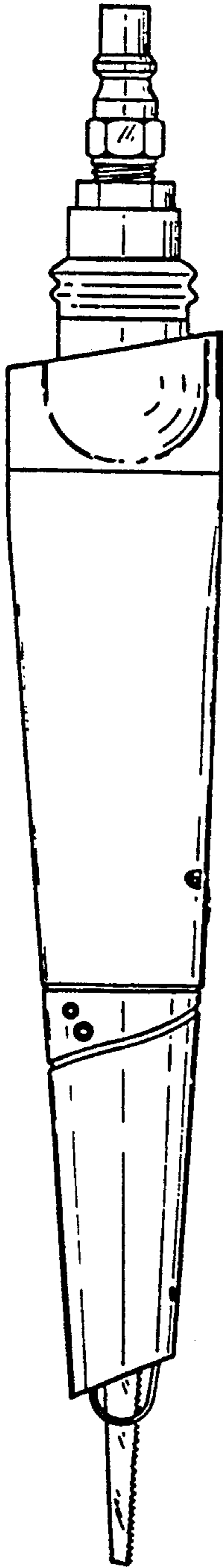

FIG. 3

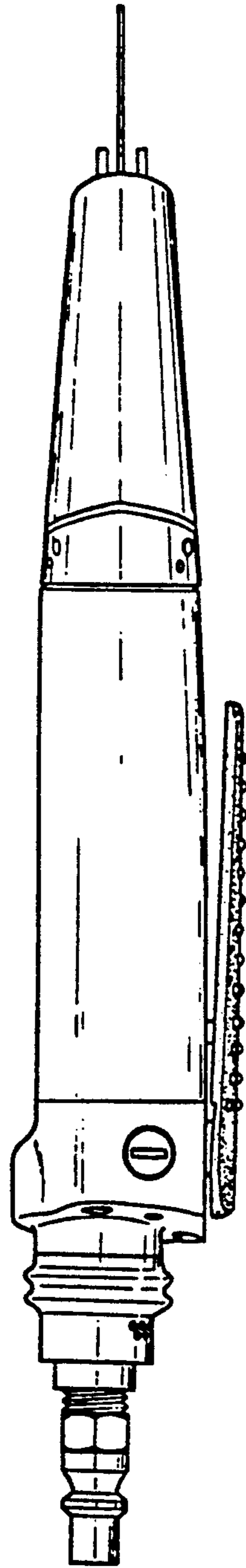

FIG. 4

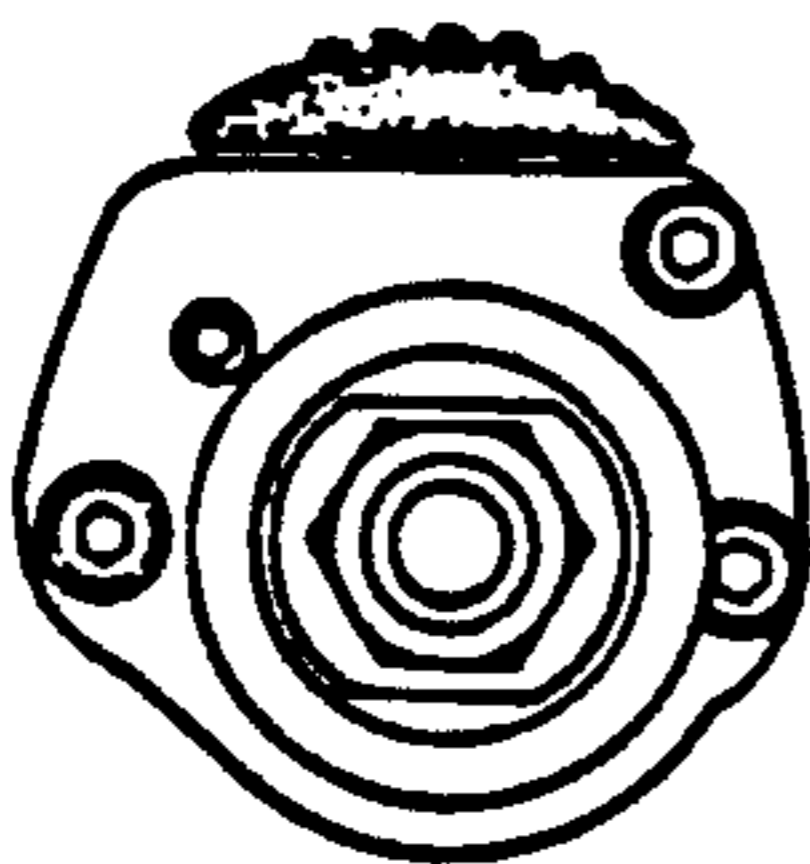

FIG. 5

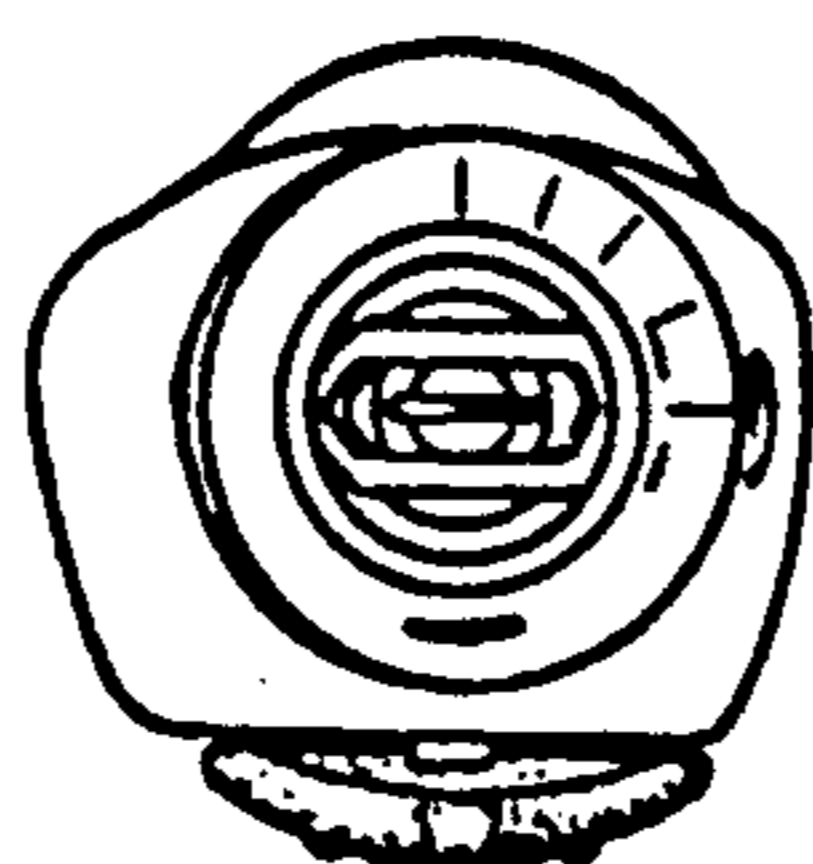

FIG. 6

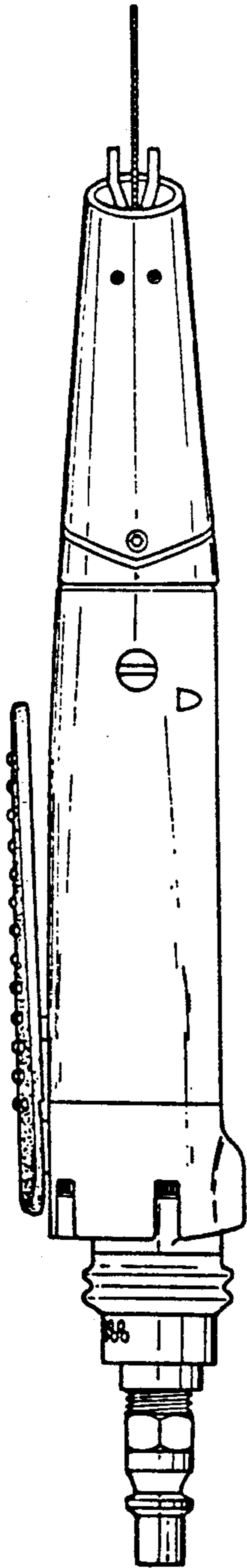

FIG. 7

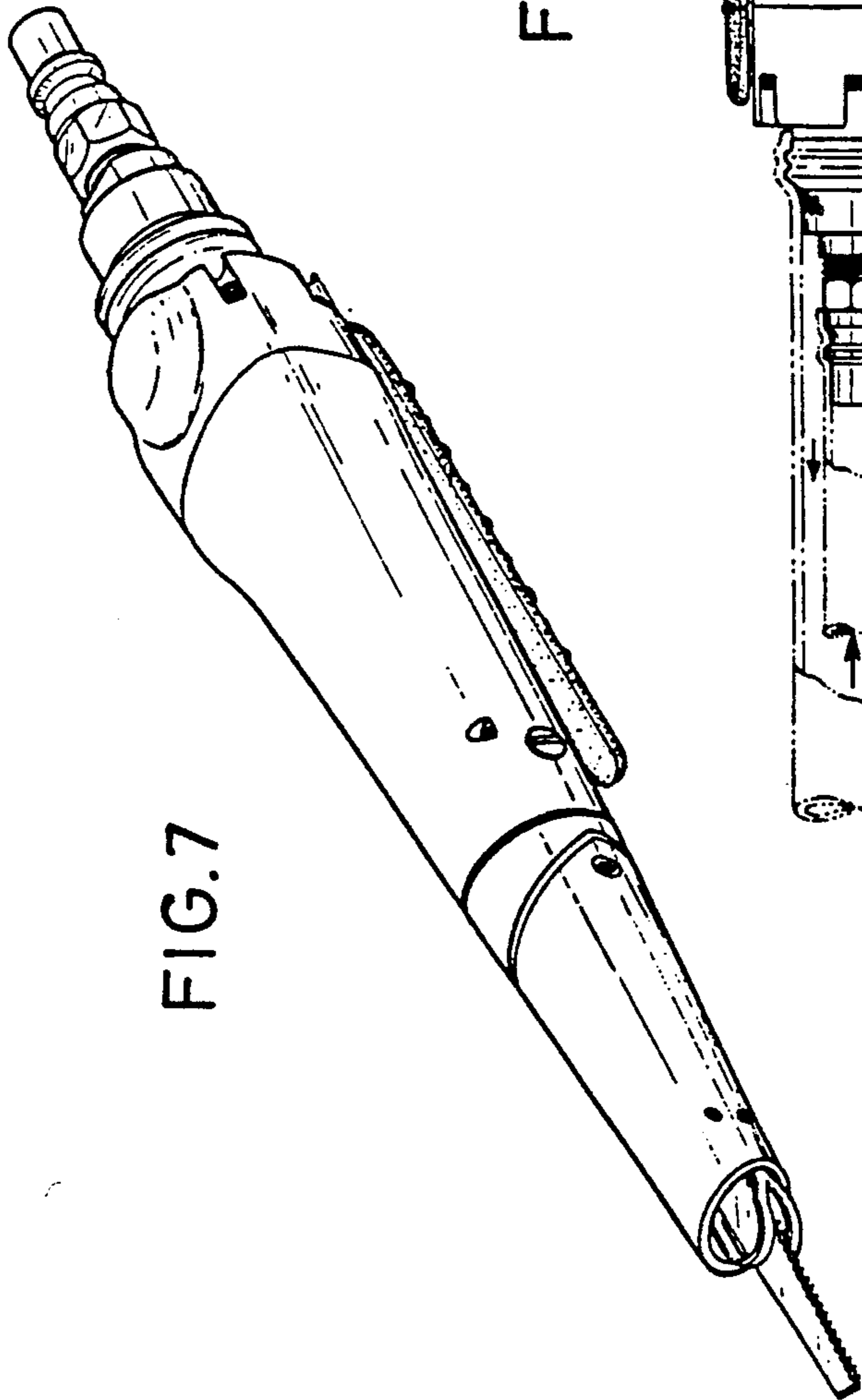

FIG. 8

