



US00D324108S

United States Patent [19]

[11] Patent Number: **Des. 324,108**

Colson

[45] Date of Patent: **** Feb. 18, 1992**

[54] **PLEAT SHAPED VERTICAL SUPPORT FOR WINDOW COVERINGS**

[75] Inventor: **Wendell Colson, Boulder, Colo.**

[73] Assignee: **Hunter Douglas Inc., Upper Saddle River, N.J.**

[**] Term: **14 Years**

[21] Appl. No.: **105,845**

[22] Filed: **Oct. 7, 1987**

[52] U.S. Cl. **D25/119**

[58] Field of Search **D25/47, 49, 119; 160/84.1, 206, 279-285, 287, 188; 248/273**

[56] **References Cited**

U.S. PATENT DOCUMENTS

| | | | |
|-----------|--------|-------------------|----------|
| 718,992 | 1/1903 | Emery . | |
| 3,509,934 | 5/1970 | Smart . | |
| 3,708,009 | 1/1973 | Viol et al. . | |
| 4,202,395 | 5/1980 | Heck et al. . | |
| 4,434,834 | 3/1984 | Ennes . | |
| 4,473,101 | 9/1984 | Langelier . | |
| 4,647,488 | 3/1987 | Schnebly et al. . | |
| 4,673,018 | 6/1987 | Judkins . | |
| 4,687,038 | 8/1987 | Clemente | 160/84.1 |
| 4,858,668 | 8/1989 | Toti | 160/84.1 |

FOREIGN PATENT DOCUMENTS

| | | |
|---------|--------|----------------------|
| 0220074 | 4/1987 | European Pat. Off. . |
| 6508988 | 1/1967 | Netherlands . |

OTHER PUBLICATIONS

Hemon Zimmers M. p. 6, Co. Dated Publication 5-1965 p. 7, top of page second item from left of page .035 Gauge.

Primary Examiner—A. Hugo Word

Assistant Examiner—Doris Clark

Attorney, Agent, or Firm—Fleit, Jacobson, Cohn, Price, Holman & Stern

[57] **CLAIM**

The ornamental design for a pleat shaped vertical support for window coverings, as shown and described.

DESCRIPTION

FIG. 1 is a perspective view of a pleat shaped vertical support for window coverings showing my new design, the broken lines showing of curtain pleats and a frame are for illustrative purposes only and form no part of the claimed design;

FIG. 2 is a top plan view thereof;

FIG. 3 is a fragmentary front elevational view thereof;

FIG. 4 is a fragmentary right side elevational view thereof;

FIG. 5 is a fragmentary rear elevational view thereof;

FIG. 6 is a fragmentary side elevational view thereof;

FIG. 7 is a top plan view thereof, the broken line showing of adjacent curtain pleats is for illustrative purposes only and form no part of the claimed design;

FIG. 8 is a top plan view of a second embodiment of a pleat shaped vertical support for window coverings showing my new design;

FIG. 9 is a fragmentary left side elevational view thereof;

FIG. 10 is top plan view of a third embodiment of a pleat shaped vertical support for window coverings showing my new design;

FIG. 11 is a fragmentary right side elevational view thereof;

FIG. 12 is a top plan view of a fourth embodiment of a pleat shaped vatical support for window coverings showing my new design;

FIG. 13 is a fragmentary right side elevational view thereof;

FIG. 14 is a top plan view of a fifth embodiment of a pleat shaped vertical support for window coverings showing my new design; and

FIG. 15 is fragmentary left side elevational view thereof.

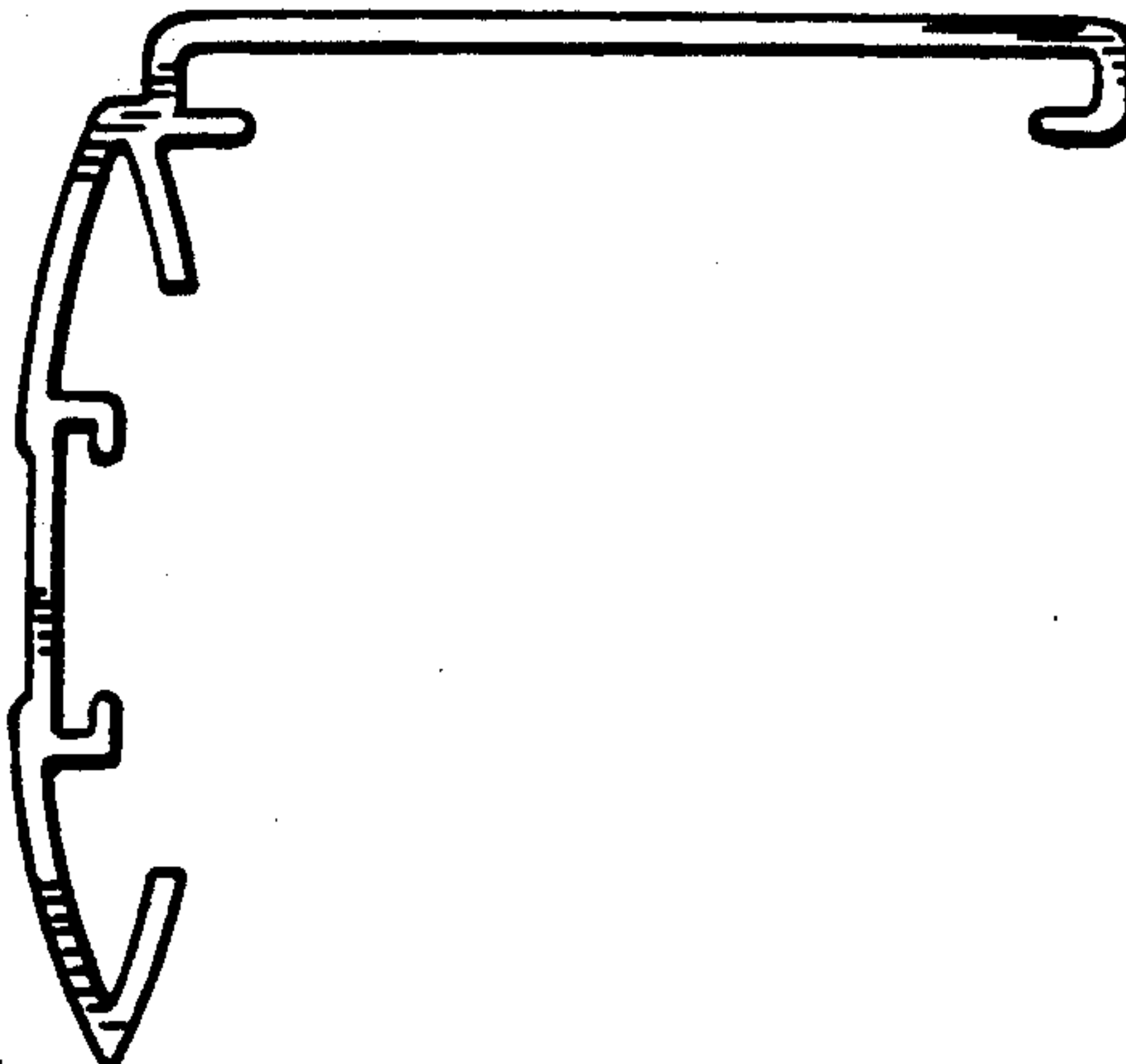

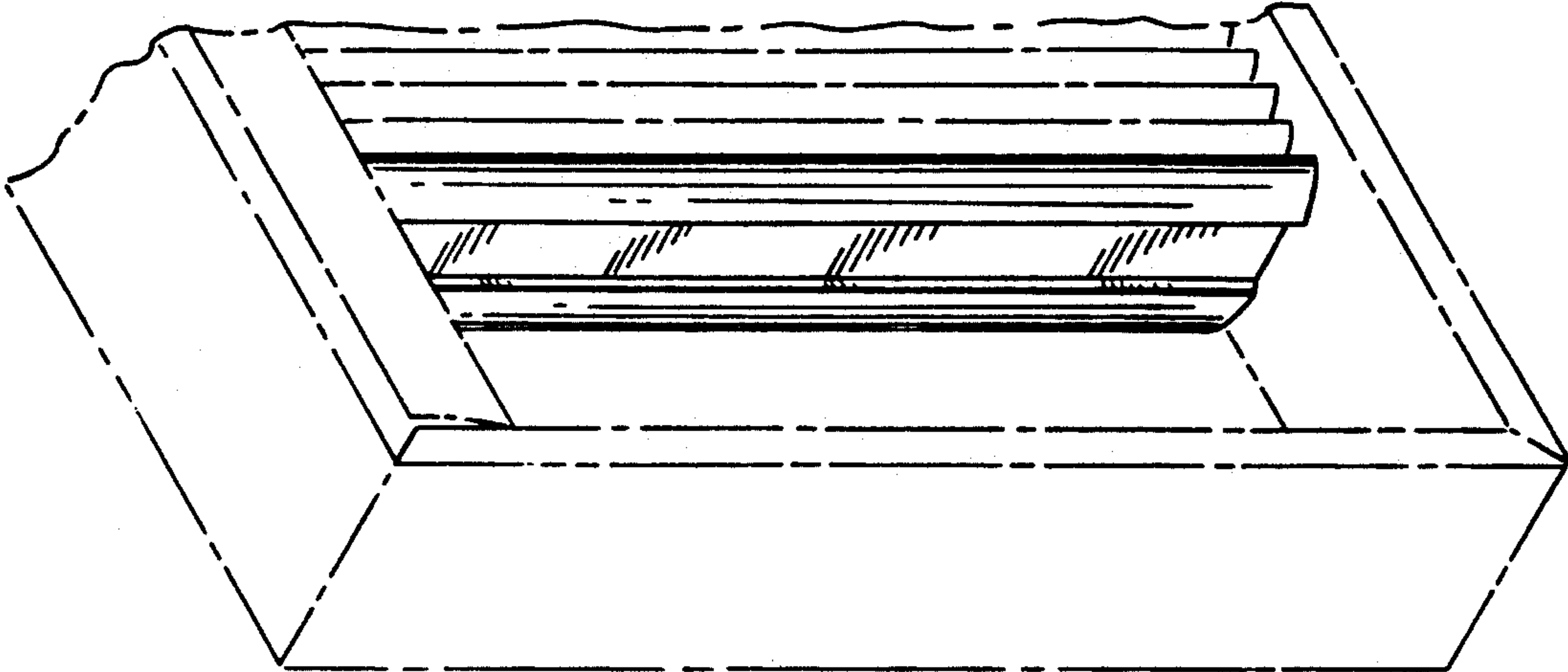

FIG. 1

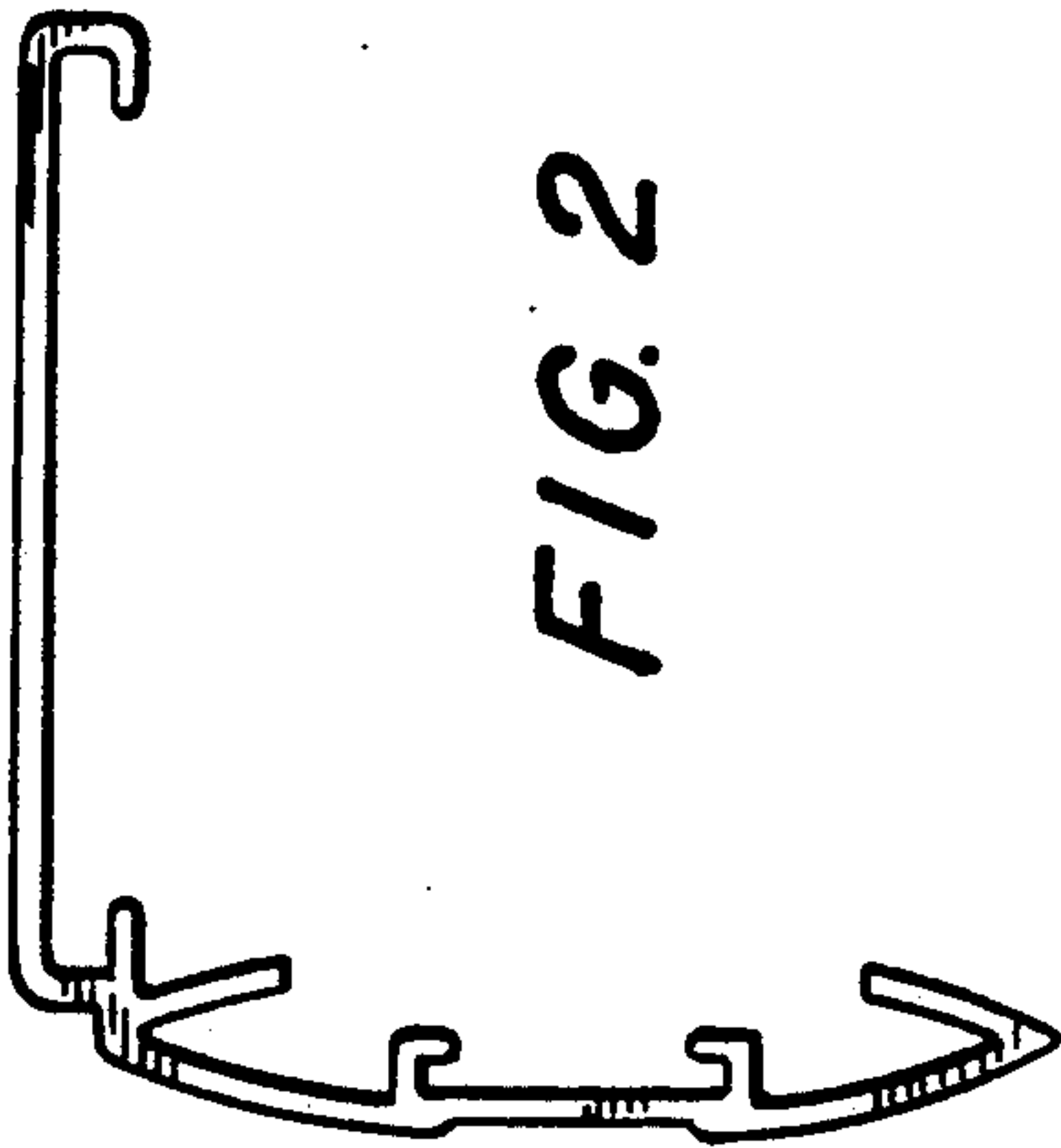

FIG. 2

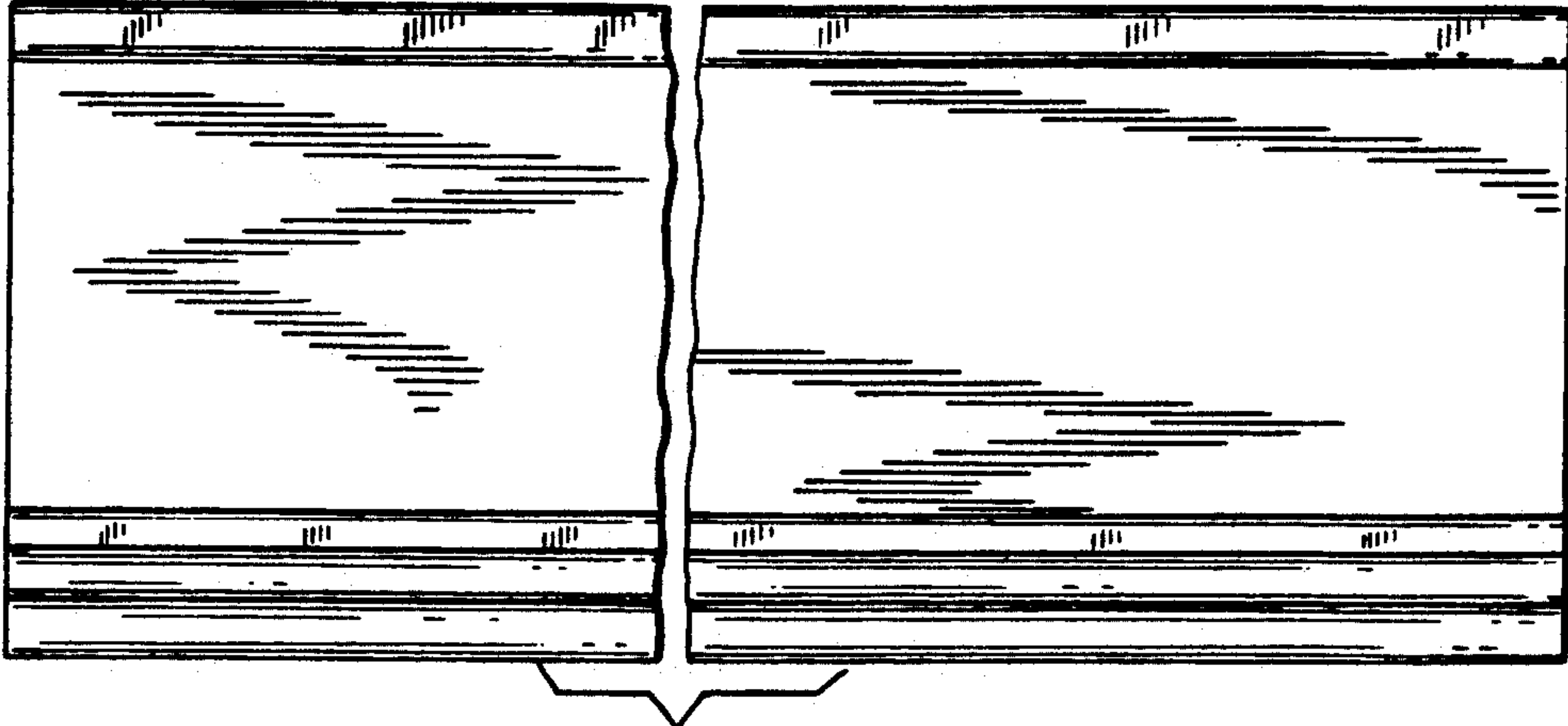

FIG. 3

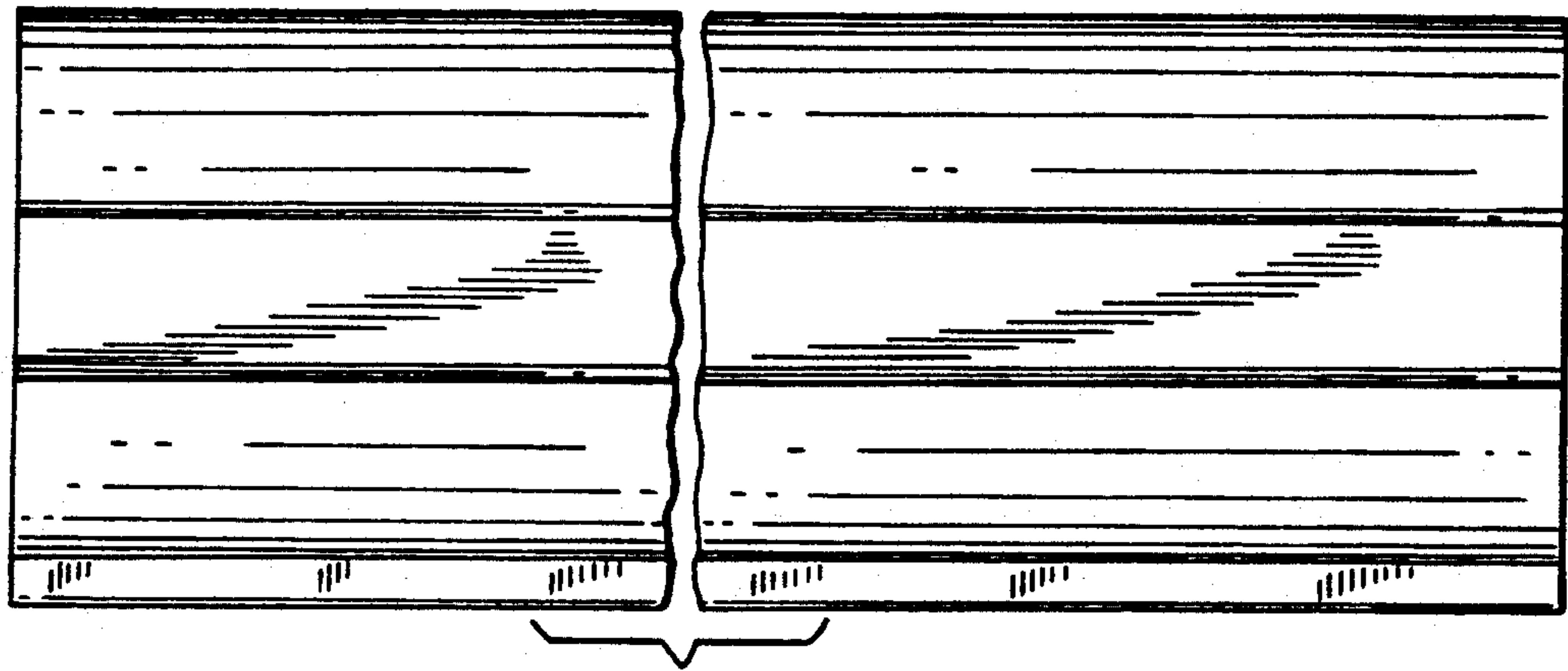

FIG. 6

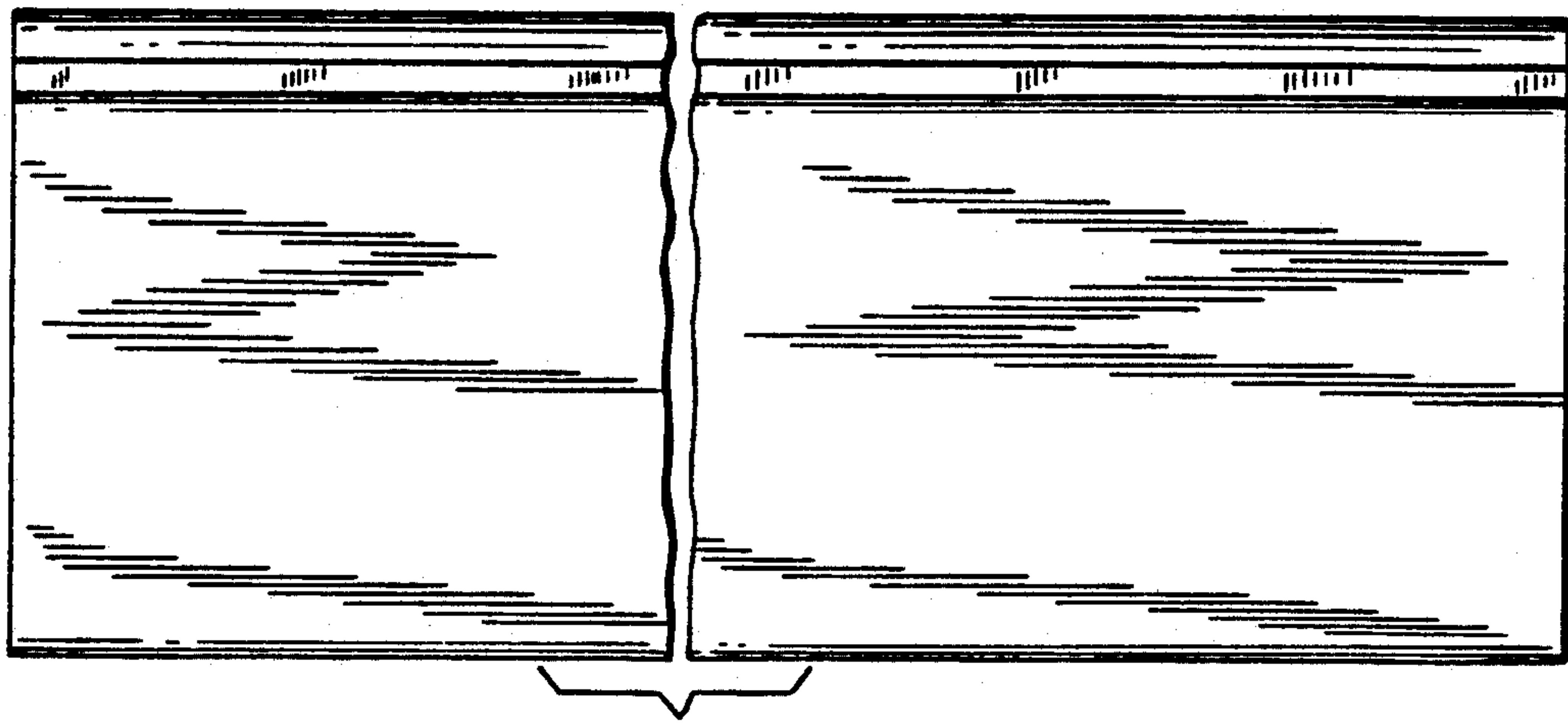

FIG. 5

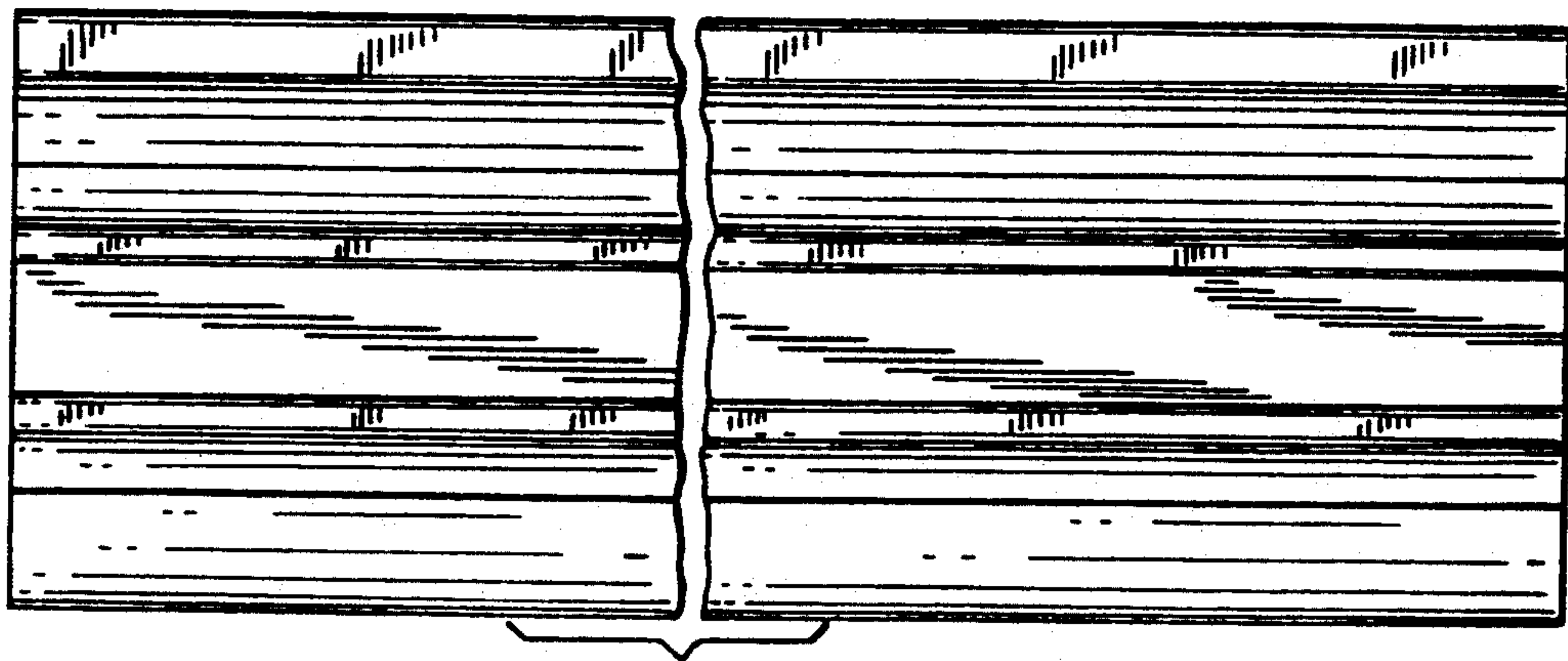

FIG. 4

FIG. 7

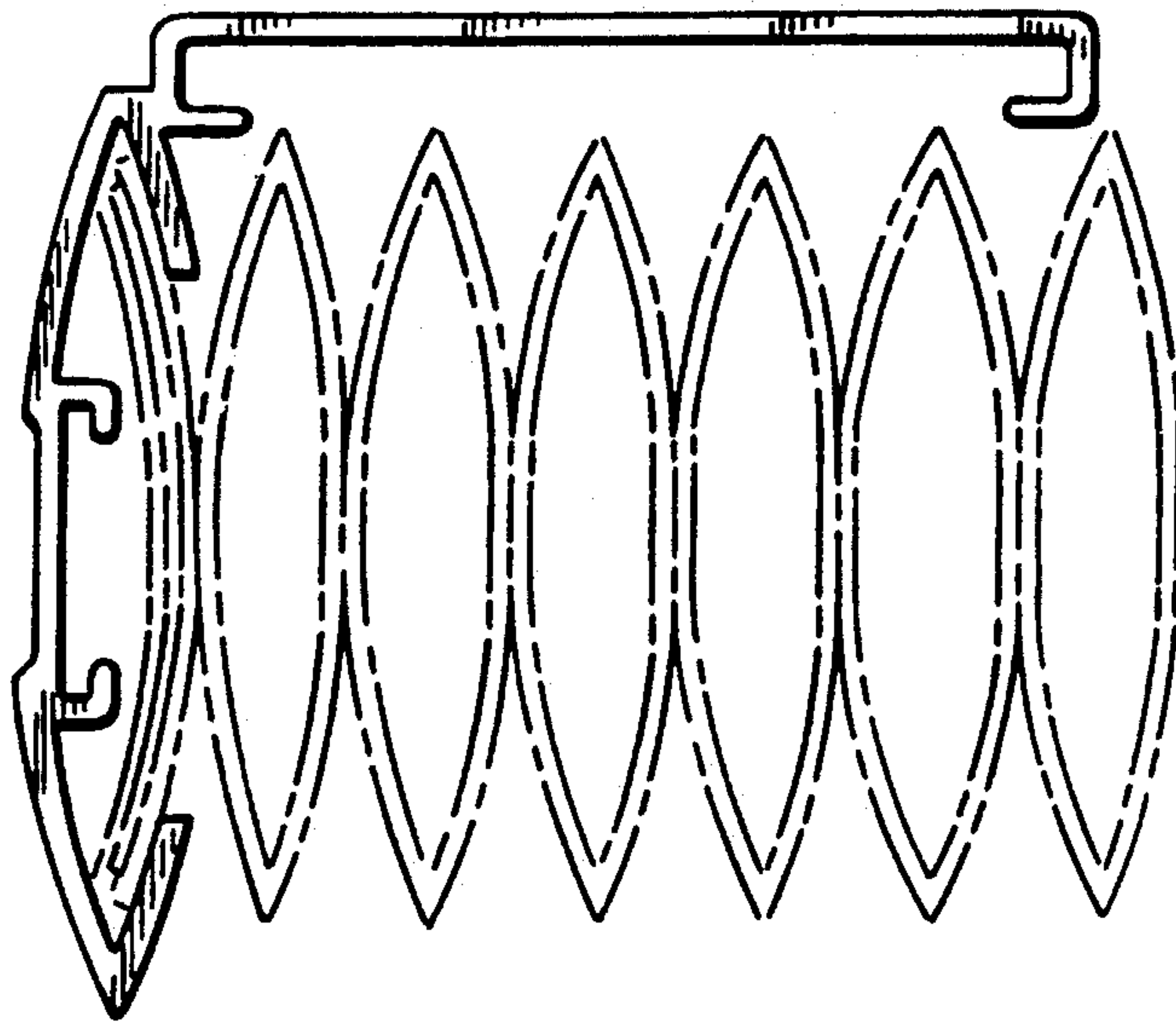

FIG. 8

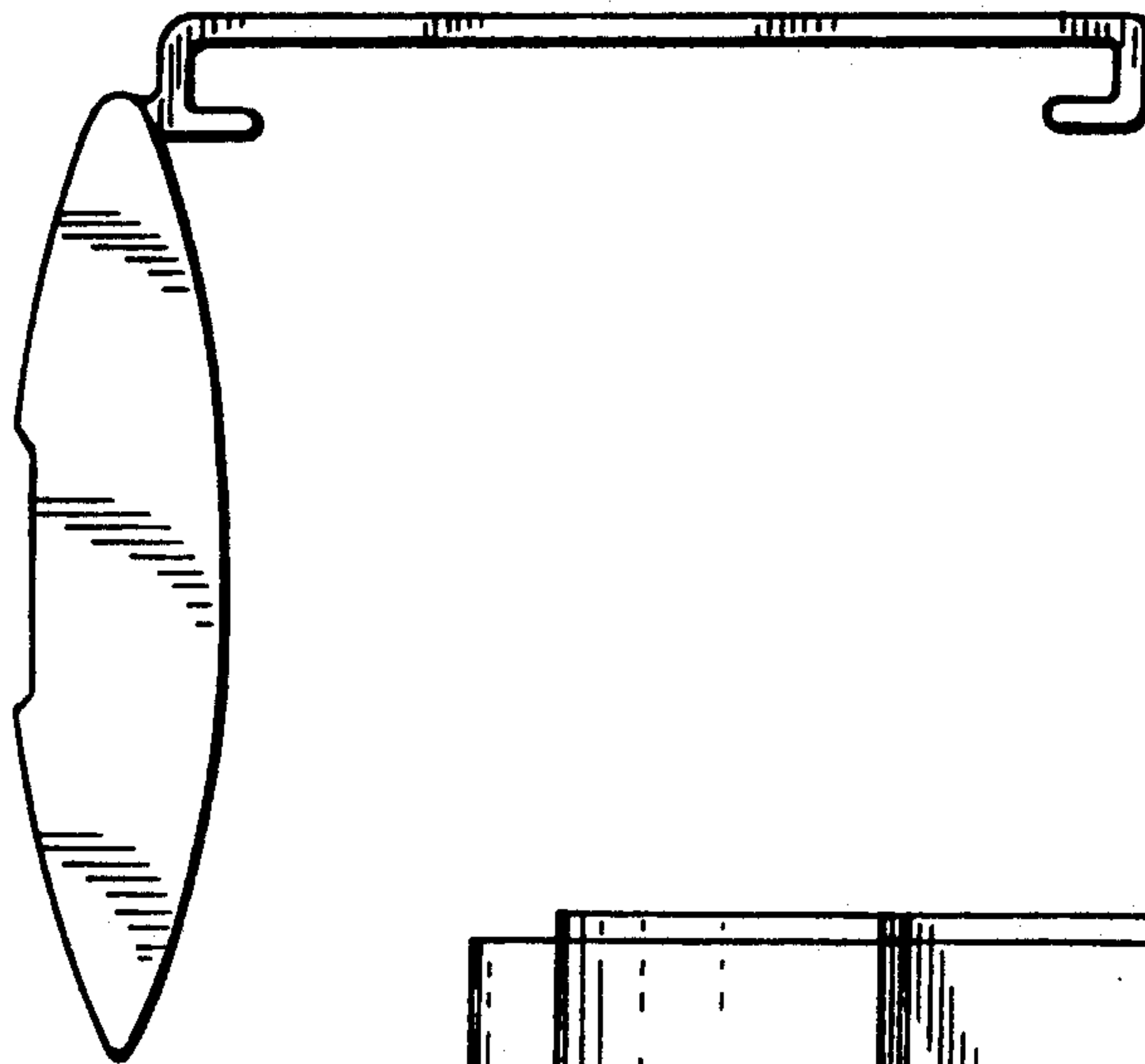

FIG. 9

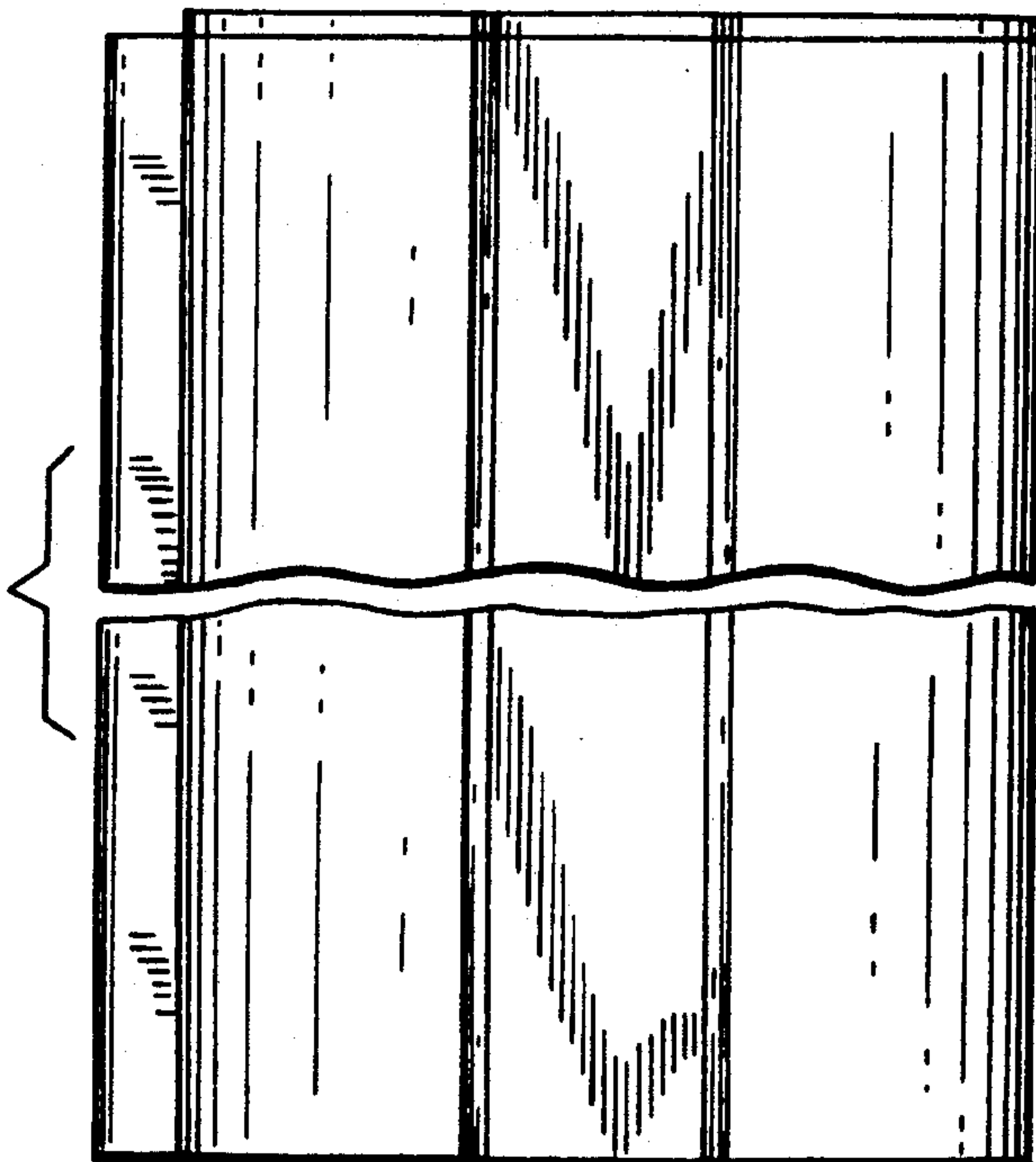

FIG. 10

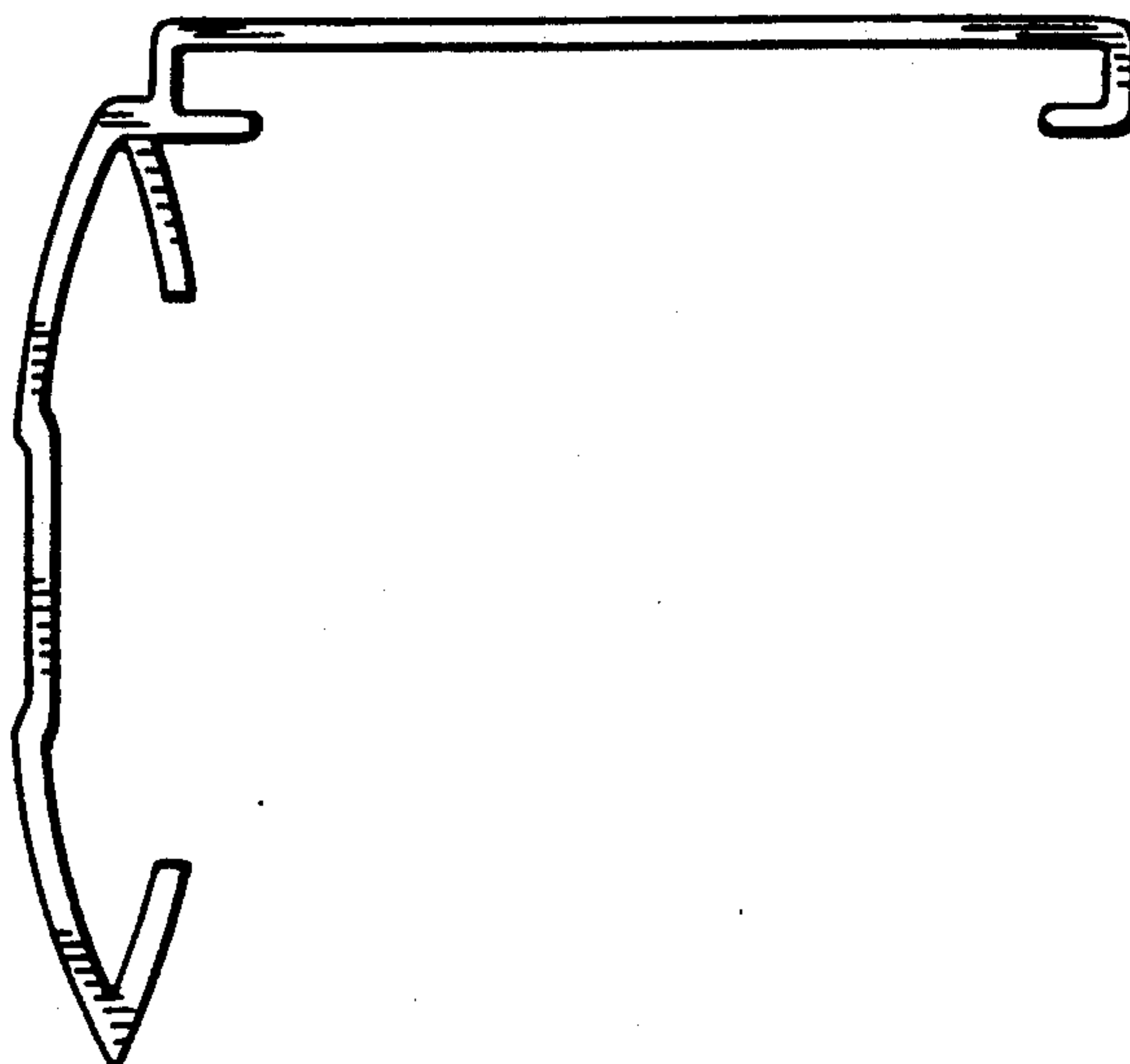

FIG. 12

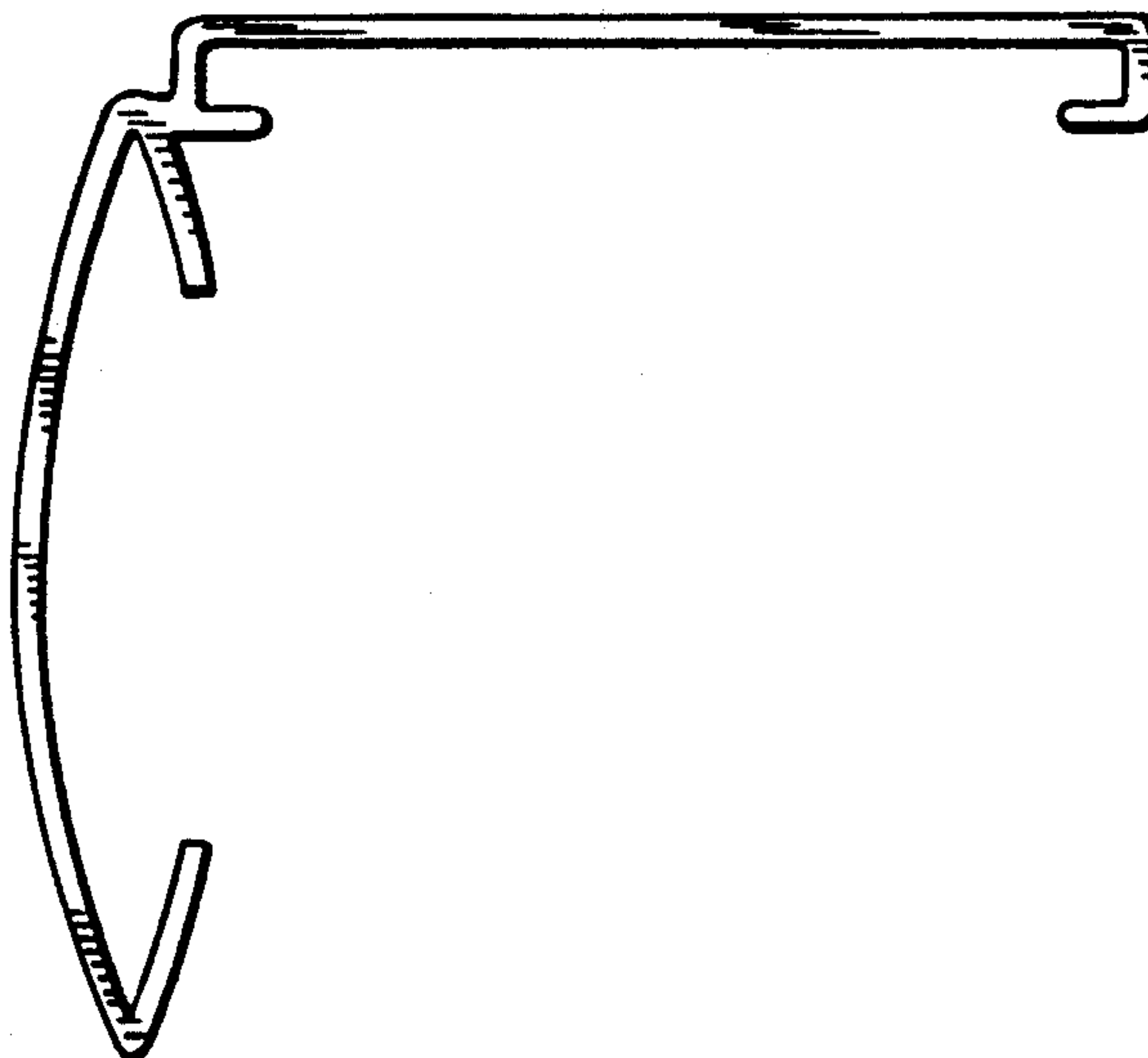

FIG. 14

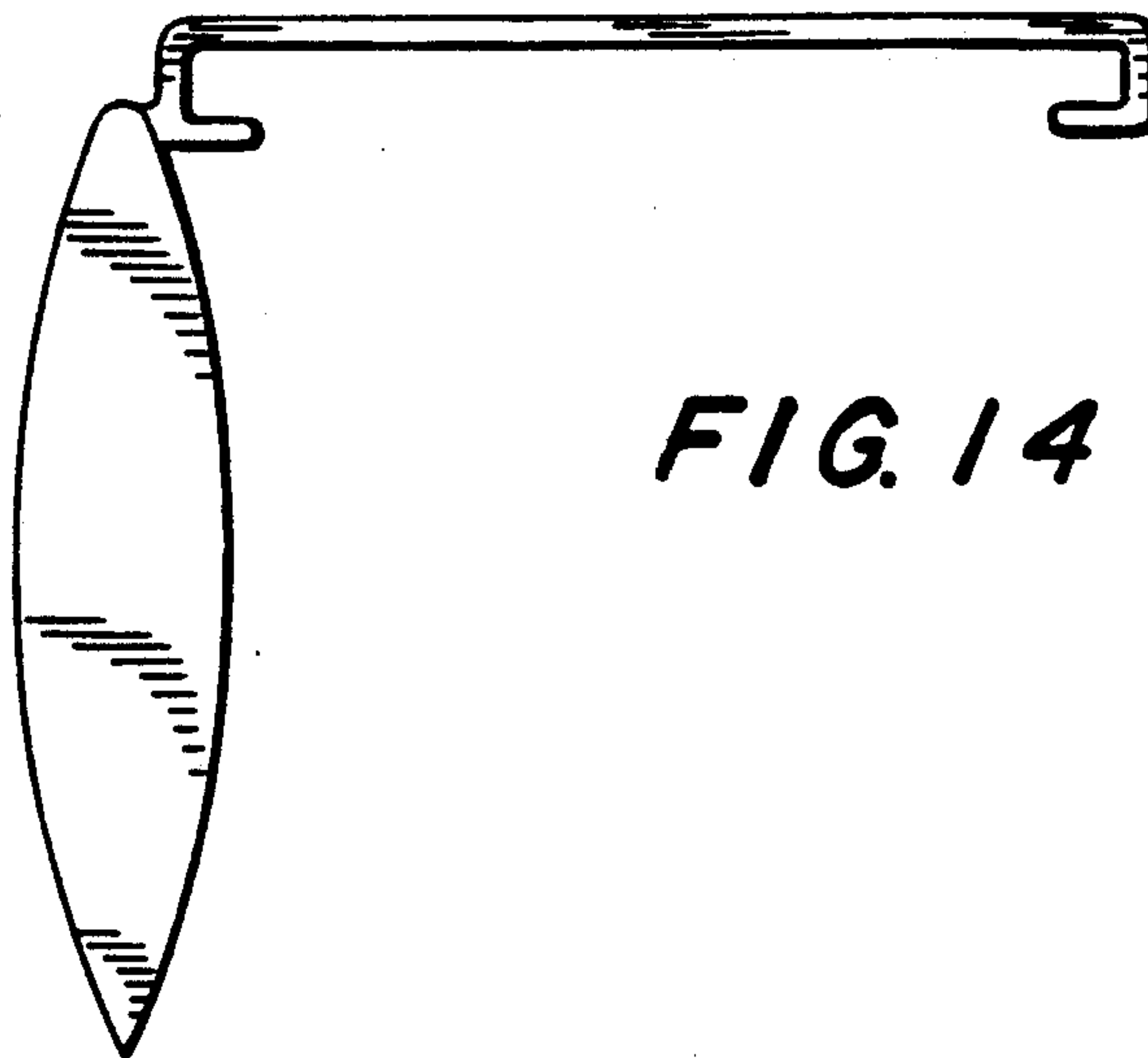

FIG. 11

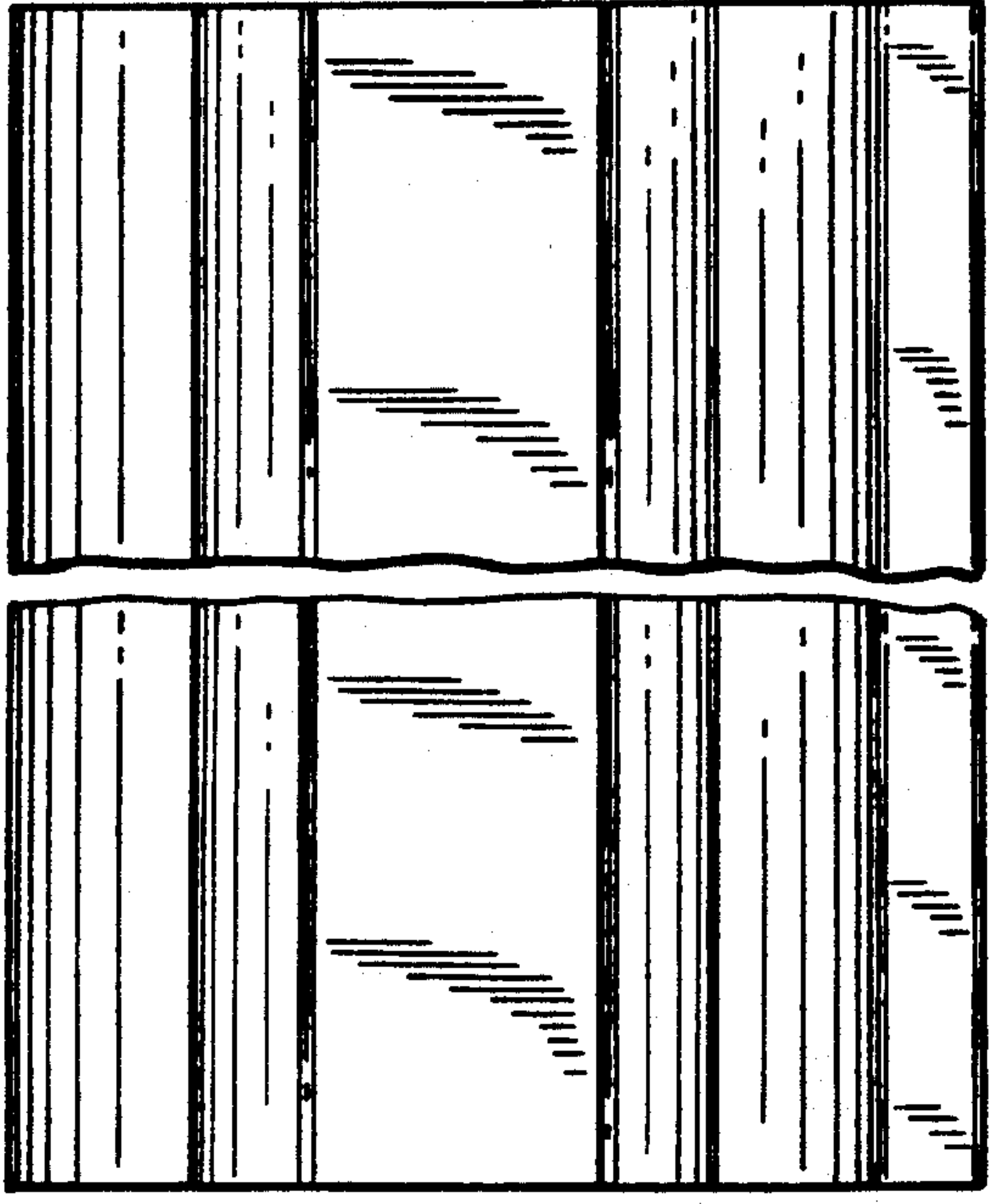

FIG. 13

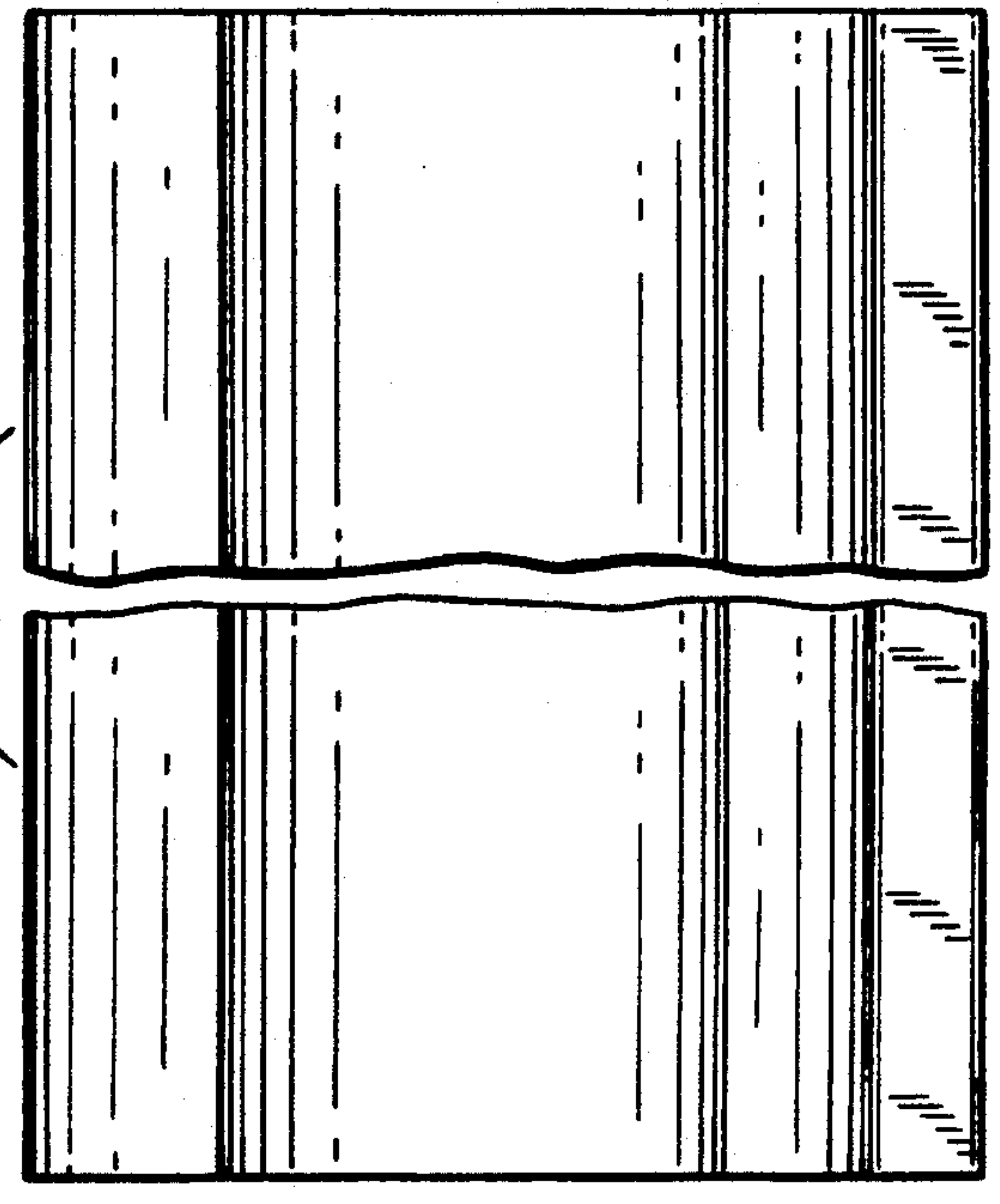
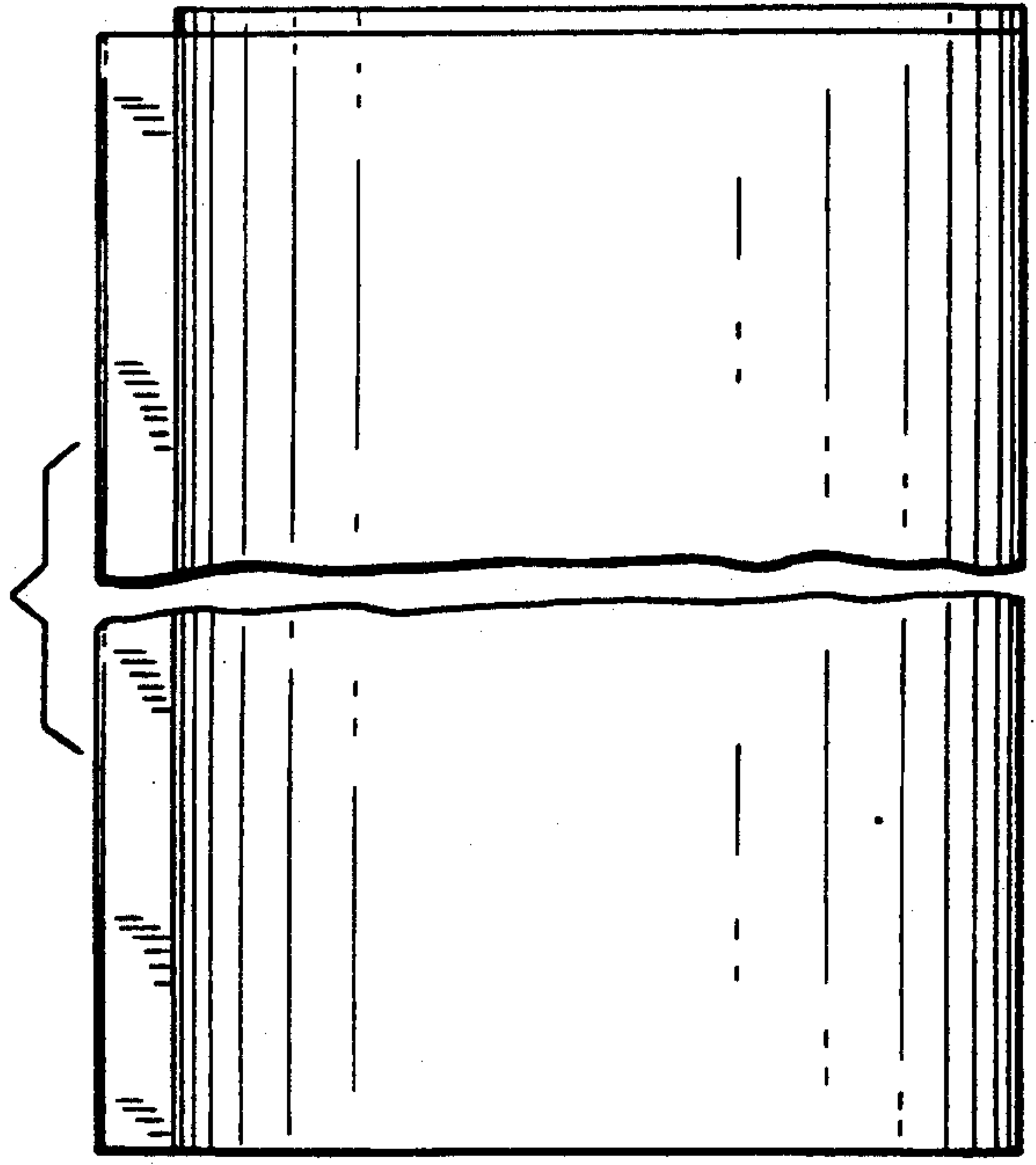

FIG. 15



UNITED STATES PATENT AND TRADEMARK OFFICE
CERTIFICATE OF CORRECTION

PATENT NO. : DES. 324,108
DATED : February 18, 1992
INVENTOR(S) : Wendell Colson

Page 1 of 2

It is certified that error appears in the above-identified patent and that said Letters Patent is hereby corrected as shown below:

On the title page:

Section [54], line 2, delete "WINDOW COVERINGS" and insert therefor -- A HORIZONTALLY EXTENDABLE AND RETRACTABLE PLEATED SHADE --;

Section [57], under "CLAIM":

line 2, delete "for window coverings";

Section [57], under "DESCRIPTION":

FIG. 1, line 2, delete "window coverings" and insert -- a horizontally extendable and retractable pleated shade --;

FIG. 8, line 2, delete "window coverings" and insert -- a horizontally extendable and retractable pleated shade --;

FIG. 10, line 2, delete "window coverings" and insert -- a horizontally extendable and retractable pleated shade --;

FIG. 12, line 2, delete "vatical" and insert -- vertical --;

FIG. 12, line 2, delete "window coverings" and insert -- a horizontally extendable and retractable pleated shade --;

UNITED STATES PATENT AND TRADEMARK OFFICE
CERTIFICATE OF CORRECTION

PATENT NO. : Des. 324,108

Page 2 of 2

DATED : February 18, 1992

INVENTOR(S) : Wendell Colson

It is certified that error appears in the above-identified patent and that said Letters Patent is hereby corrected as shown below:

FIG. 14, line 2, delete "window coverings" and insert --
a horizontally extendable and retractable pleated shade --.

**Signed and Sealed this
Twenty-eighth Day of July, 1992**

Attest:

DOUGLAS B. COMER

Attesting Officer

Acting Commissioner of Patents and Trademarks