



US00D324027S

United States Patent [19]

[11] Patent Number: **Des. 324,027**

Sueyoshi et al.

[45] Date of Patent: **** Feb. 18, 1992**

[54] **ELECTRICAL CONNECTOR HOUSING**

[75] Inventors: **Tadahiro Sueyoshi; Masanori Tsuji; Yoshihiro Murakami; Takayuki Yamamoto; Masaru Fukuda**, all of Shizuoka; **Hidetaka Okabe**, Toyota; **Yasuhiro Nagasaka**, Toyota; **Yasuo Hirayama**, Toyota, all of Japan

[73] Assignees: **Yazaki Corporation**, Tokyo; **Toyota Jidosha Kabushiki Kaisha**, Toyota, both of Japan

[**] Term: **14 Years**

[21] Appl. No.: **470,567**

[22] Filed: **Jan. 26, 1990**

[30] **Foreign Application Priority Data**

Jul. 31, 1989 [JP] Japan 1-28074

[52] U.S. Cl. **D13/133**

[58] Field of Search **D13/133, 146, 147; 439/248, 345, 350, 352, 353, 358, 544, 586, 587, 595, 596, 598, 600, 682, 752**

[56] **References Cited**

U.S. PATENT DOCUMENTS

D. 308,512 6/1990 Endo et al. D13/133
D. 311,733 10/1990 Kuzuno et al. D13/133

D. 317,900 7/1991 Nagasaka et al. D13/133
D. 319,813 9/1991 Kozono D13/133
3,843,224 10/1974 Gerke, Jr. et al. 439/350 X
4,826,452 5/1989 Sian et al. 439/595

Primary Examiner—Susan J. Lucas
Assistant Examiner—J. Sincavage

[57] **CLAIM**

The ornamental design for an electrical connector housing, as shown and described.

DESCRIPTION

FIG. 1 is a top plan view of an electrical connector housing showing our new design; FIG. 2 is a front elevational view thereof; FIG. 3 is a bottom plan view thereof; FIG. 4 is a right side elevational view thereof, the left side elevational view thereof being a mirror image; FIG. 5 is a rear elevational view thereof; FIG. 6 is a cross-sectional view thereof taken along line 6—6 of FIG. 2; FIG. 7 is a cross-sectional view thereof taken along line 7—7 of FIG. 2; FIG. 8 is a front and upper right perspective view thereof. The broken line showing of the conductors, corresponding housing and other related members is included for the purpose of illustrating environmental elements only and forms no part of the claimed design.

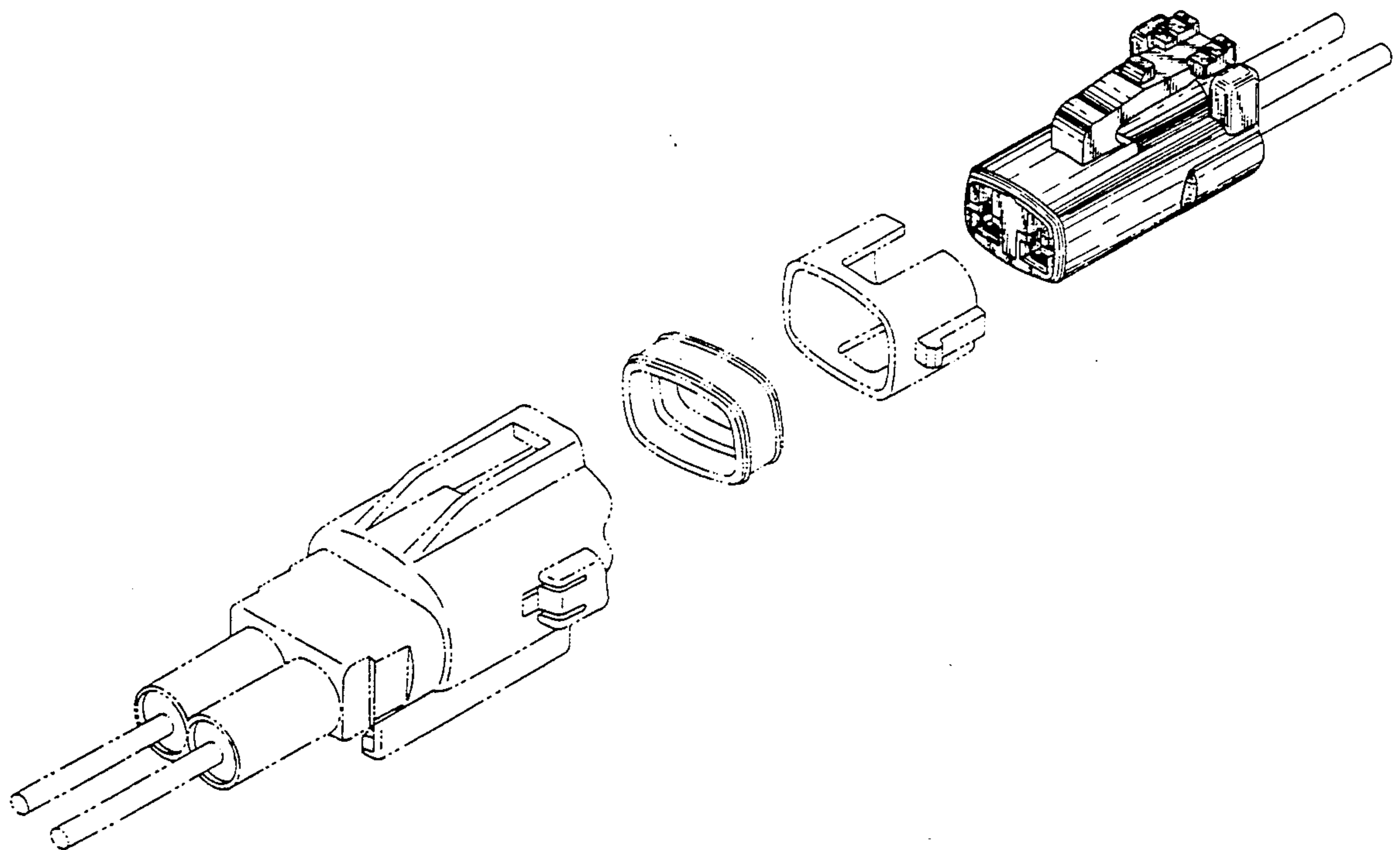

FIG. 1

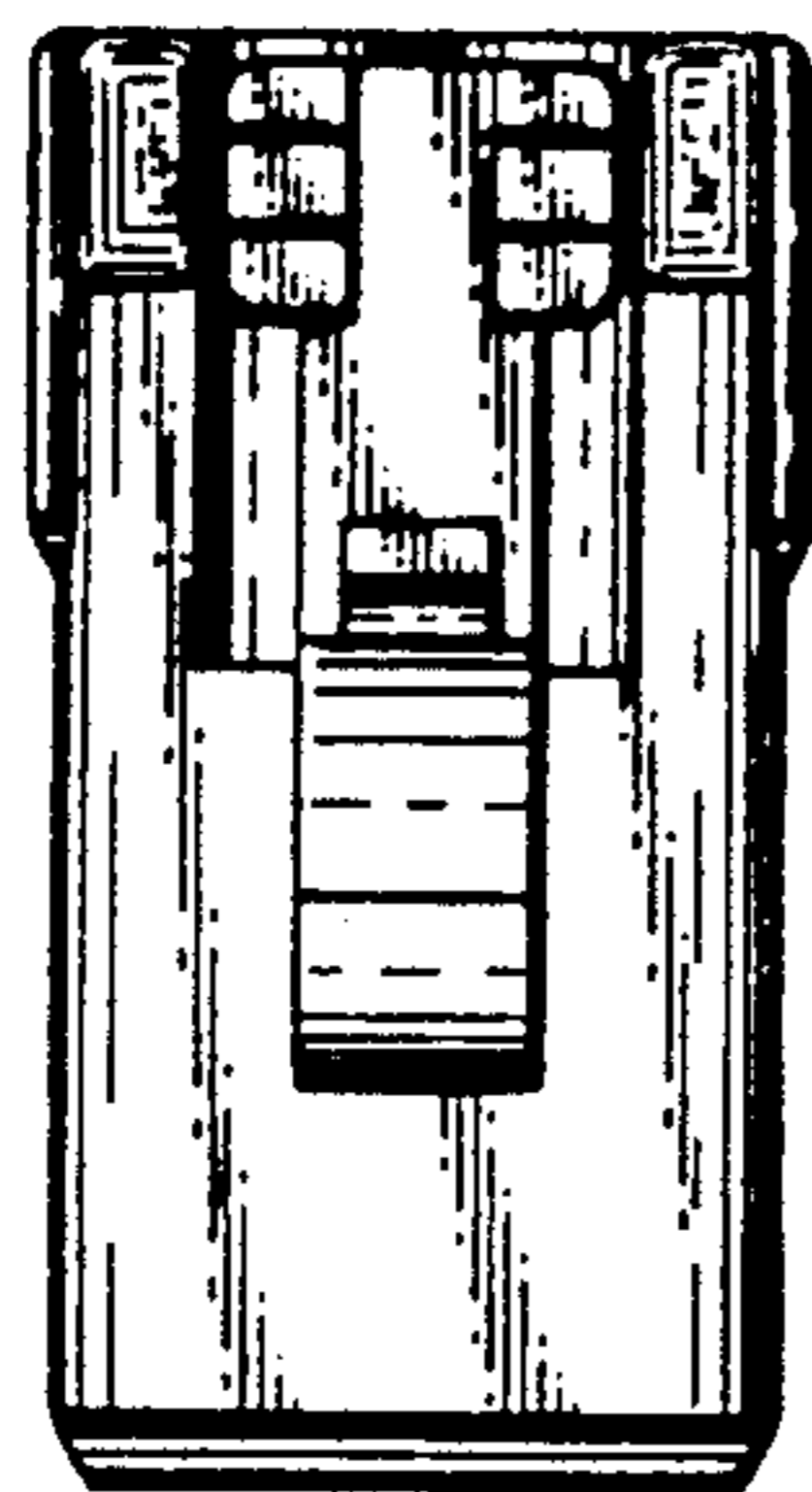

FIG. 3

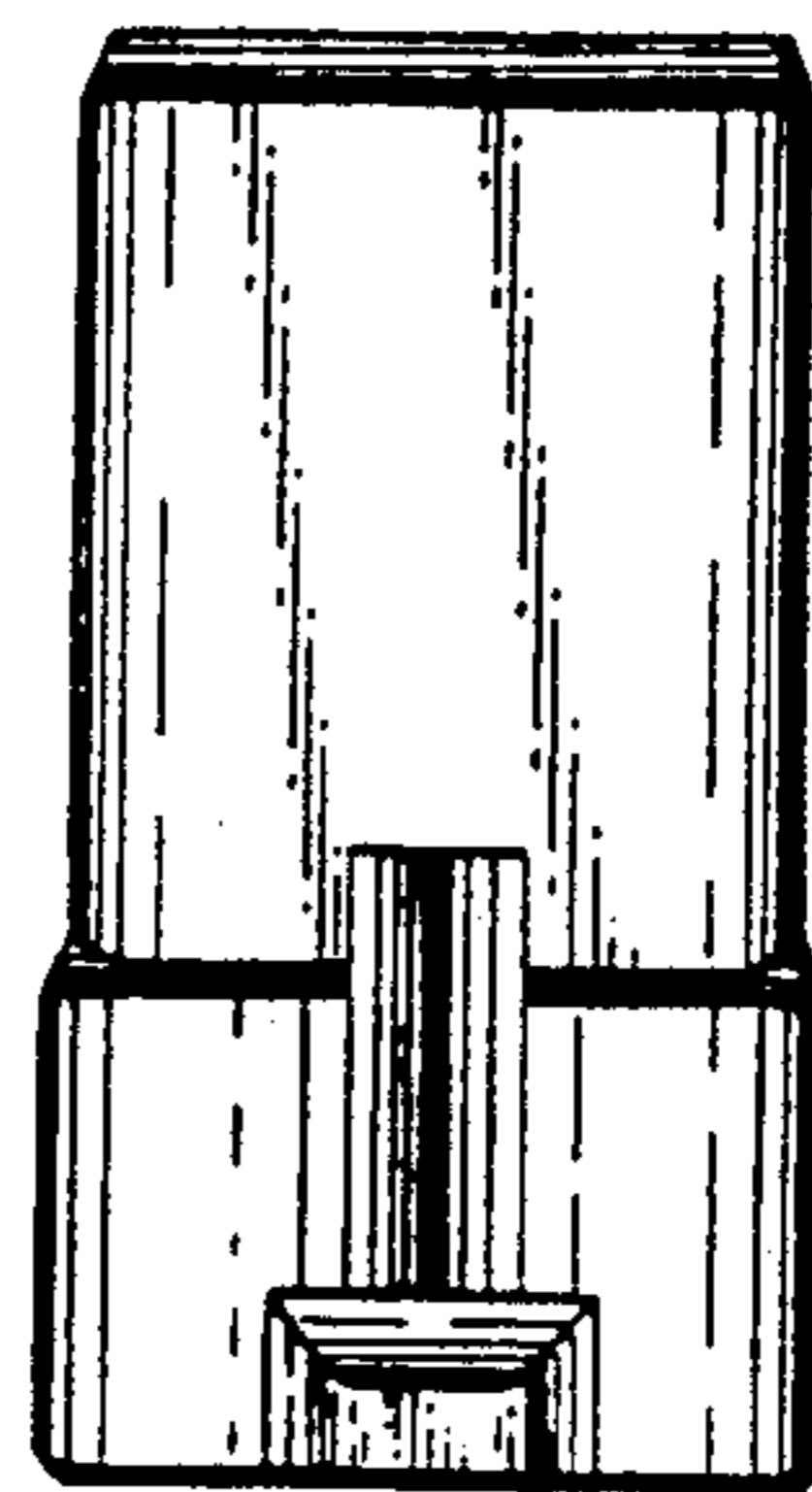

FIG. 4

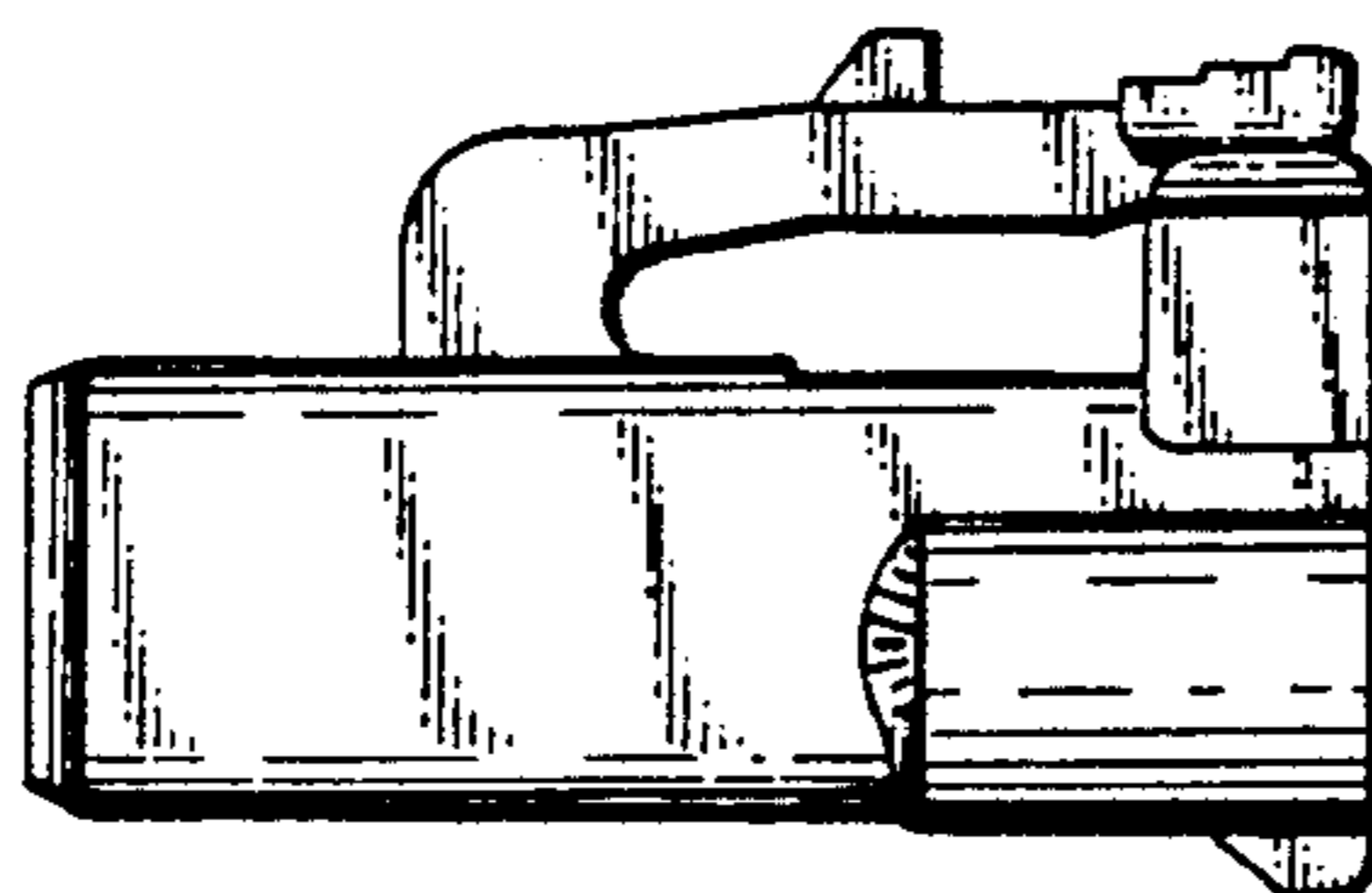

FIG. 2

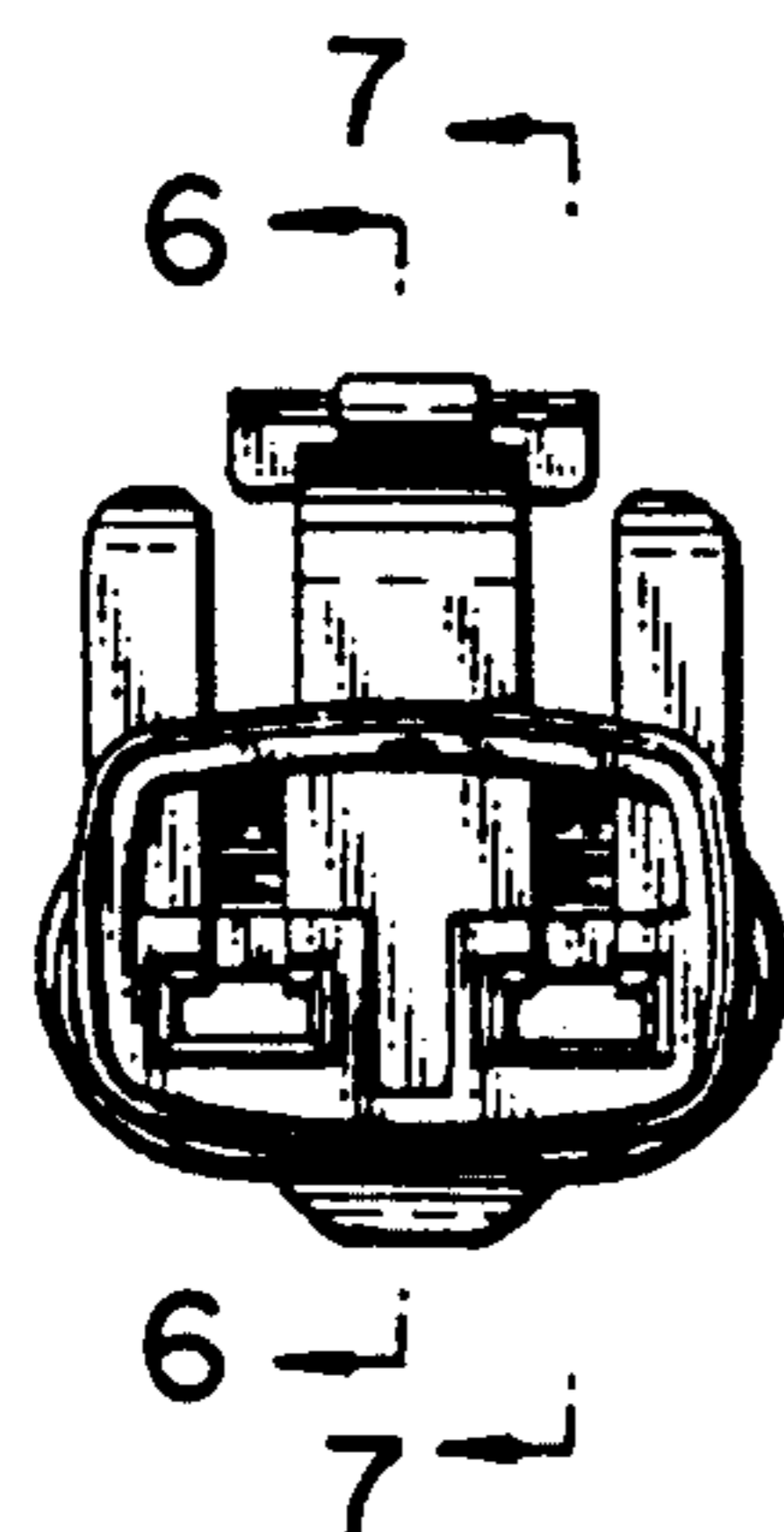

FIG. 5

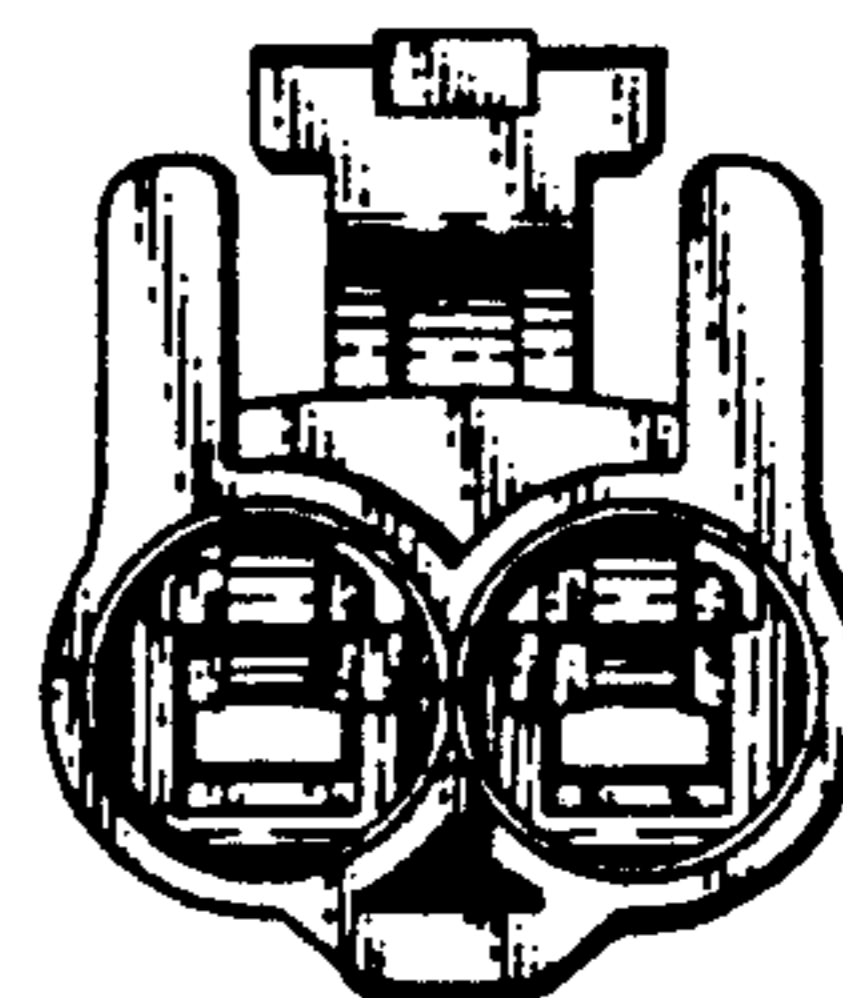

FIG. 6

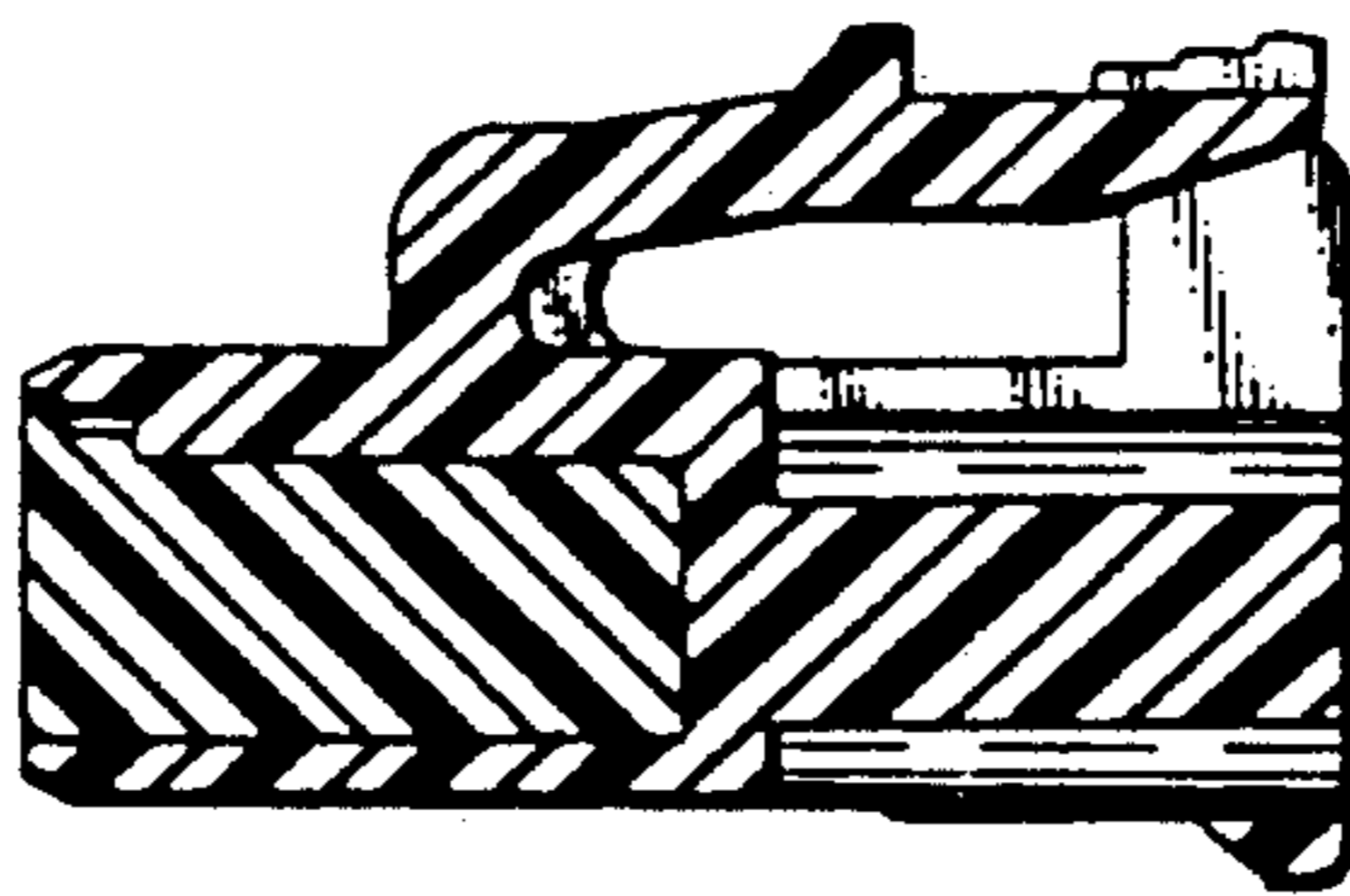

FIG. 7

