



US00D323951S

United States Patent [19]

Inoue

[11] Patent Number: **Des. 323,951**

[45] Date of Patent: **** Feb. 18, 1992**

[54] **VACUUM BOTTLE**

[75] Inventor: **Tsunemichi Inoue**, Osaka, Japan

[73] Assignee: **Zojirushi Corporation**, Osaka, Japan

[**] Term: **14 Years**

[21] Appl. No.: **348,934**

[22] Filed: **May 8, 1989**

[52] U.S. Cl. **D7/317; D7/319**

[30] **Foreign Application Priority Data**

Dec. 28, 1988 [JP] Japan 1-4230
[58] **Field of Search** **D7/317, 319, 300, 312, D7/316, 318**

[56] **References Cited**

U.S. PATENT DOCUMENTS

- D. 217,734 6/1970 Abramson et al. D7/317
- D. 218,354 8/1970 Kikuchi D7/317
- D. 285,520 9/1986 Ferm et al. D7/318 X
- D. 299,901 2/1989 Huang D7/317
- D. 304,146 10/1989 Weernink D7/312 X

OTHER PUBLICATIONS

Gifts & Decorative Accessories, Oct. 1983, p. 118, bottom left, "Thermique Server/Corning Designs".

HFD, Aug. 22, 1988, p. 54, bottom right, Donvier, "Clean Water Maker".

Primary Examiner—Winifred E. Herrmann
Attorney, Agent, or Firm—Armstrong, Nikaido, Marmelstein, Kubovcik and Murray

[57] **CLAIM**

The ornamental design for a vacuum bottle, as shown and described.

DESCRIPTION

FIG. 1 is a top, rear and side perspective view of a vacuum bottle showing my new design;

FIG. 2 is a top, front, and side perspective view thereof;

FIG. 3 is a bottom plan view thereof;

FIG. 4 is a left side elevational view, the right side view being a mirror image thereof;

FIG. 5 is a top plan view thereof;

FIG. 6 is a front elevational view thereof;

FIG. 7 is a rear elevational view thereof; and

FIG. 8 is a cross-sectional view thereof.

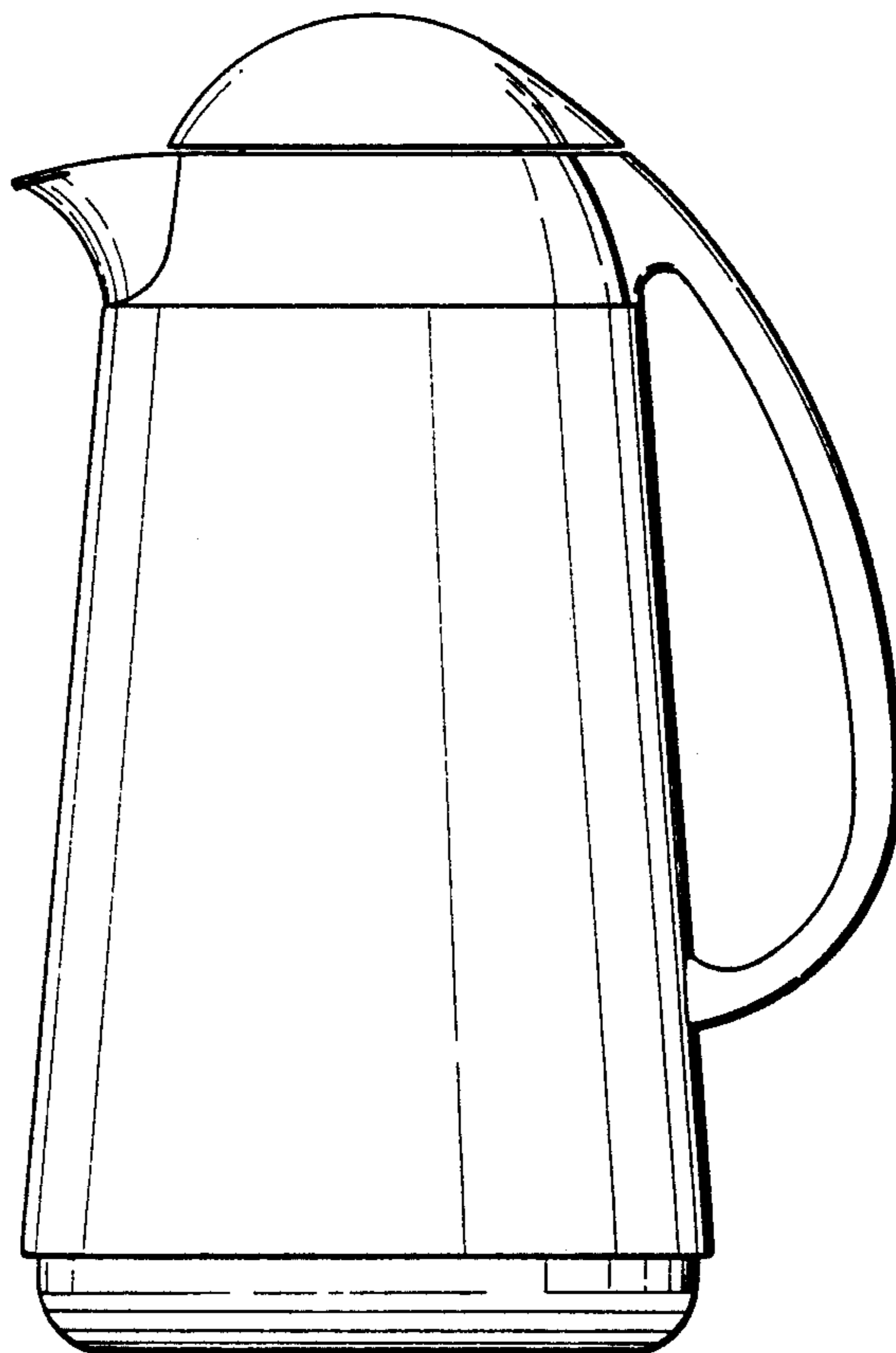
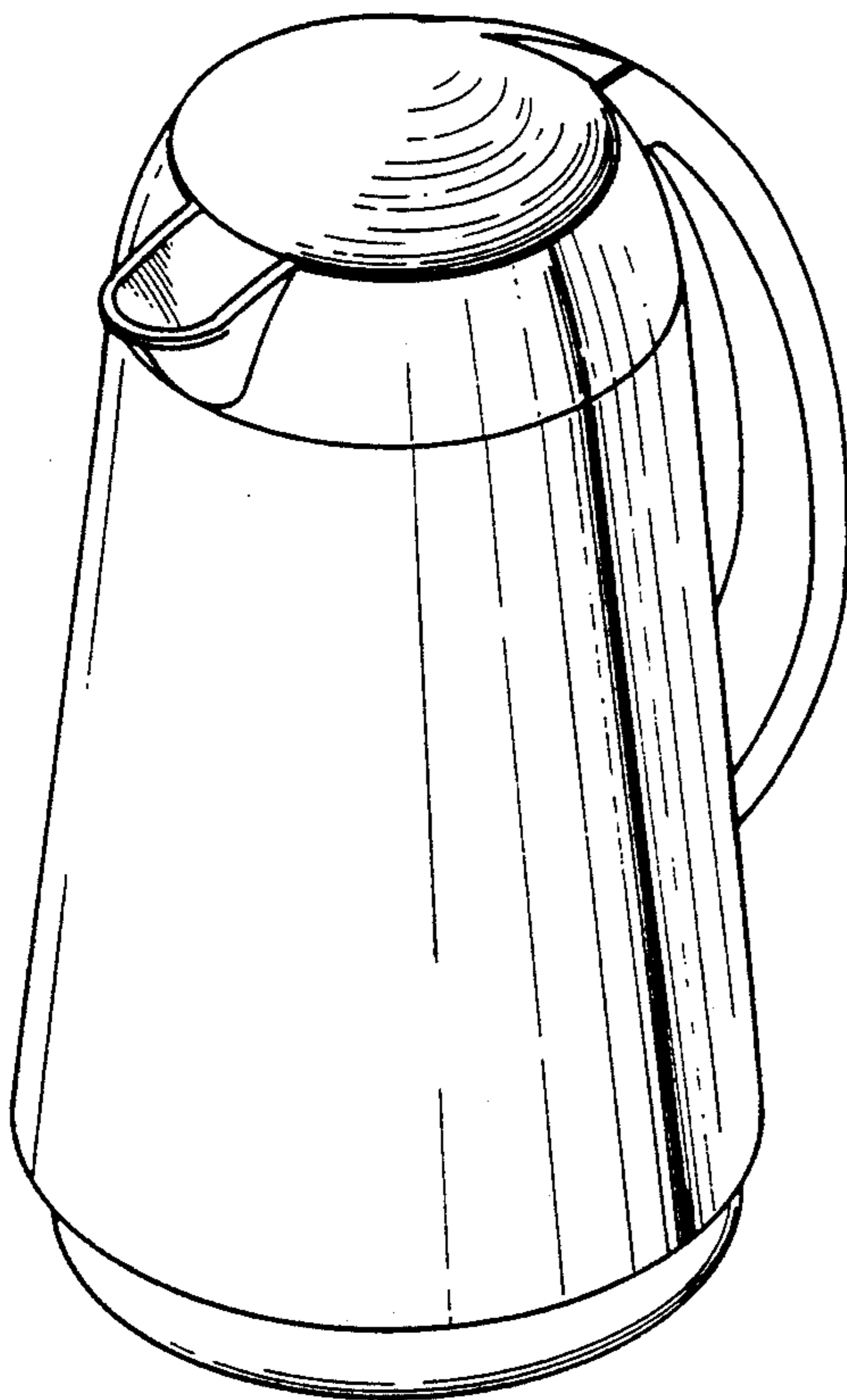

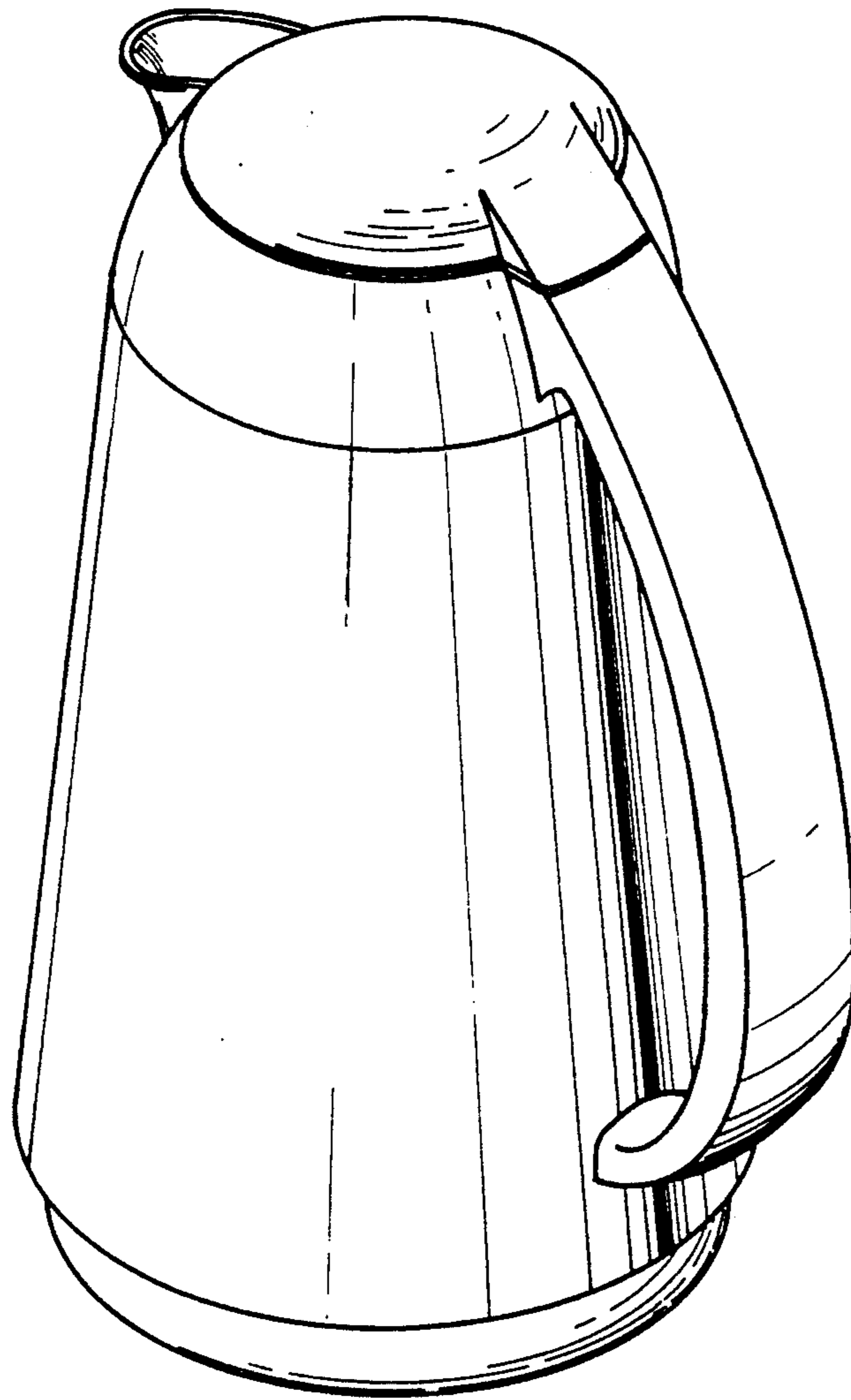

FIG. 1

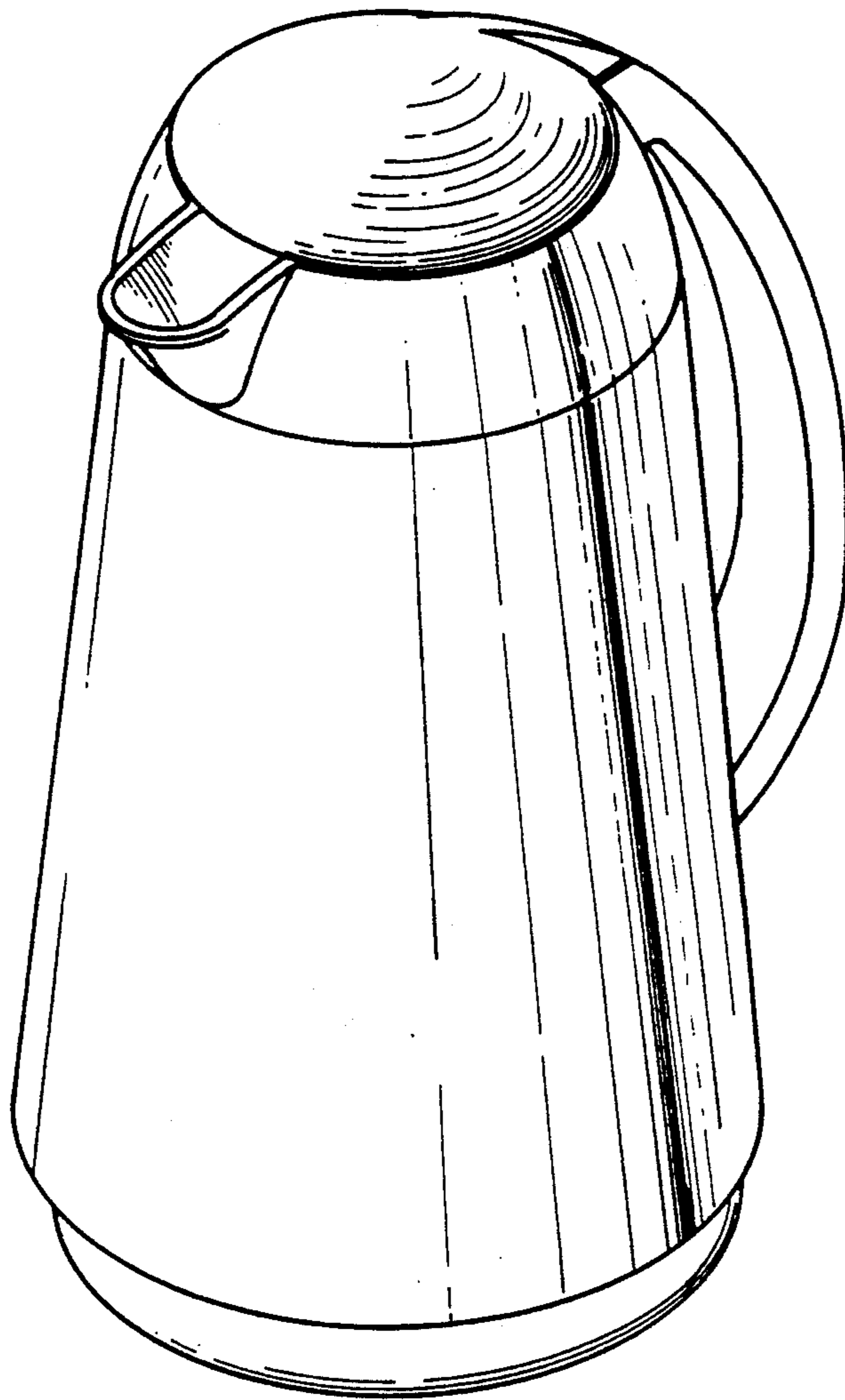

FIG. 2

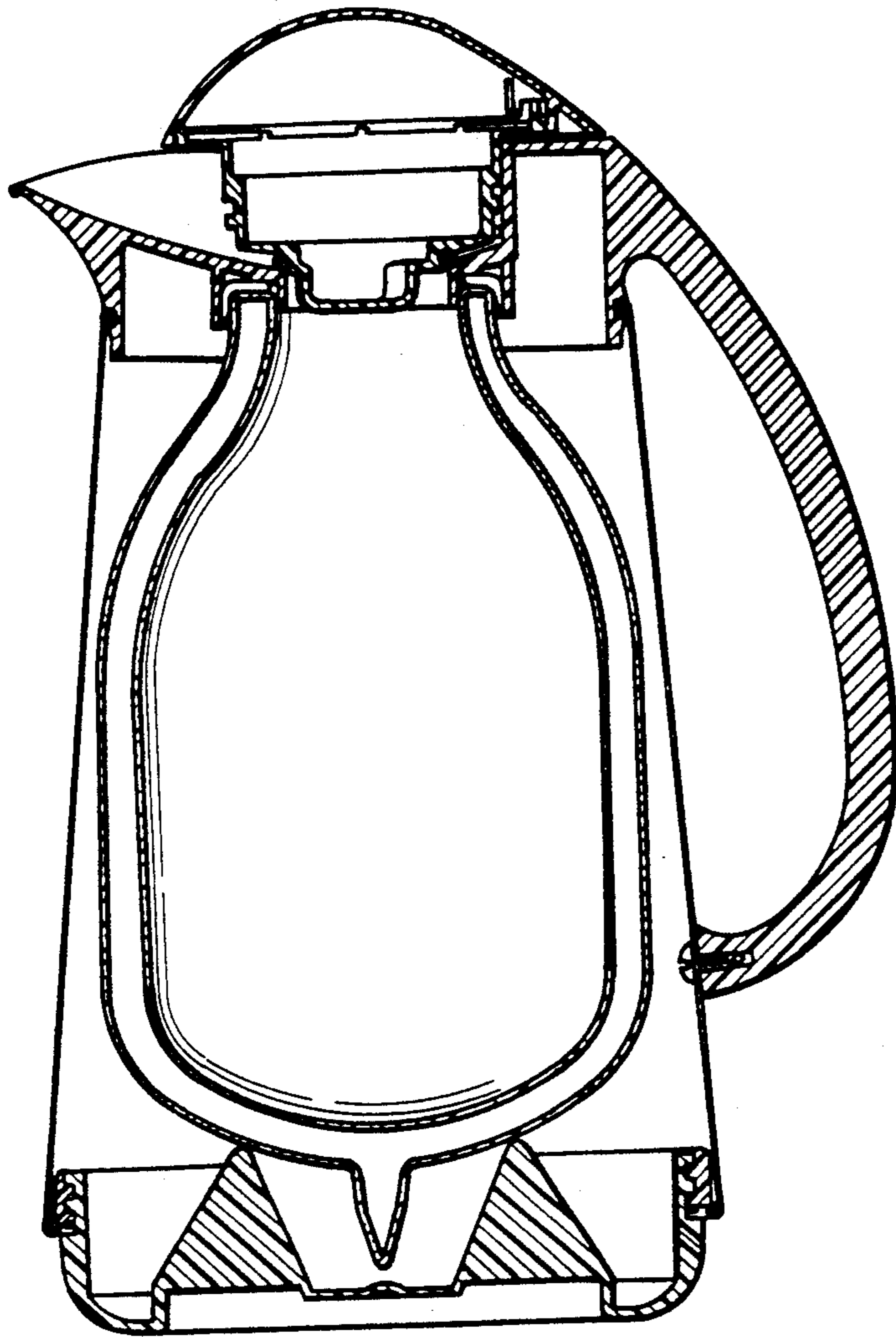

FIG. 8

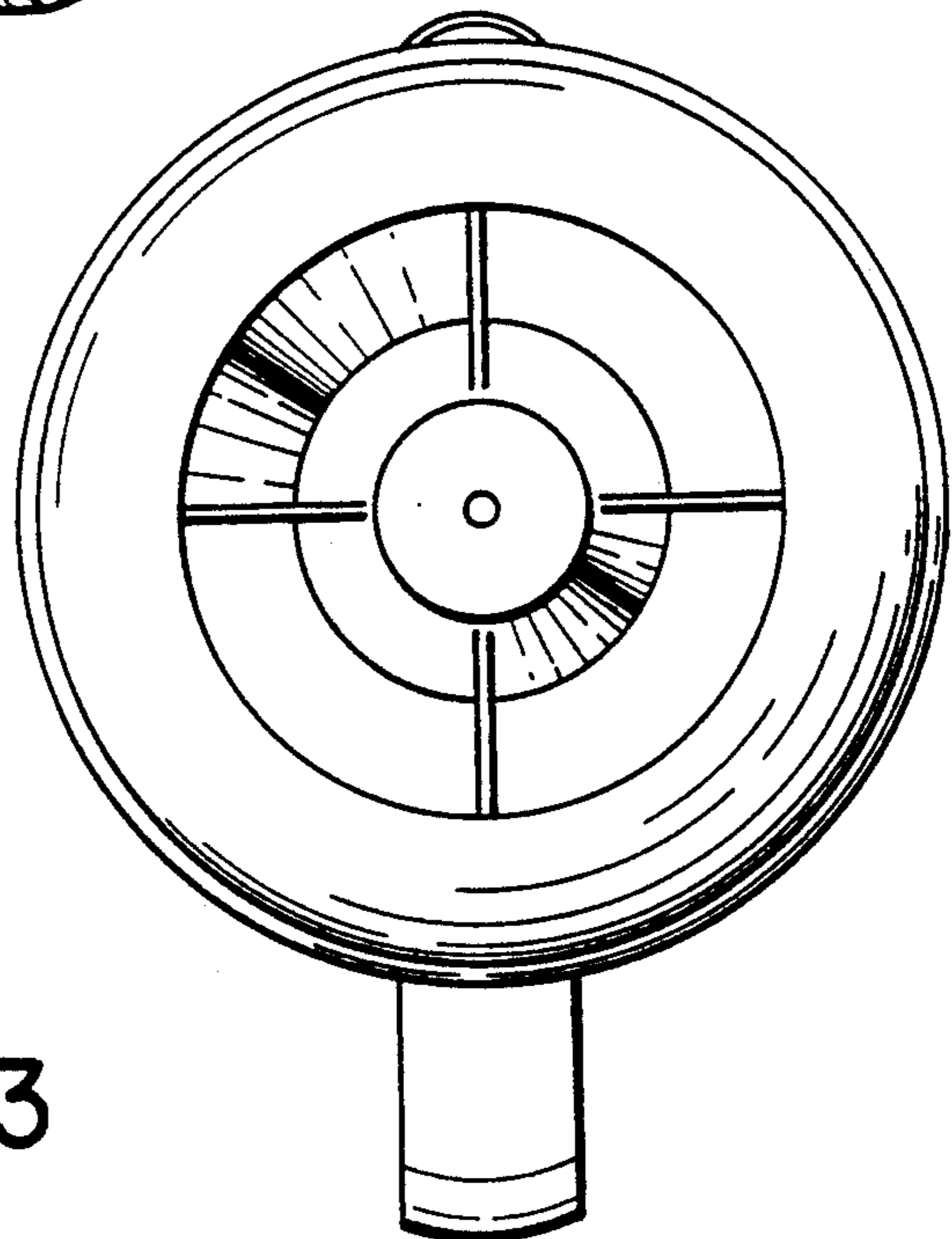

FIG. 3



FIG. 4

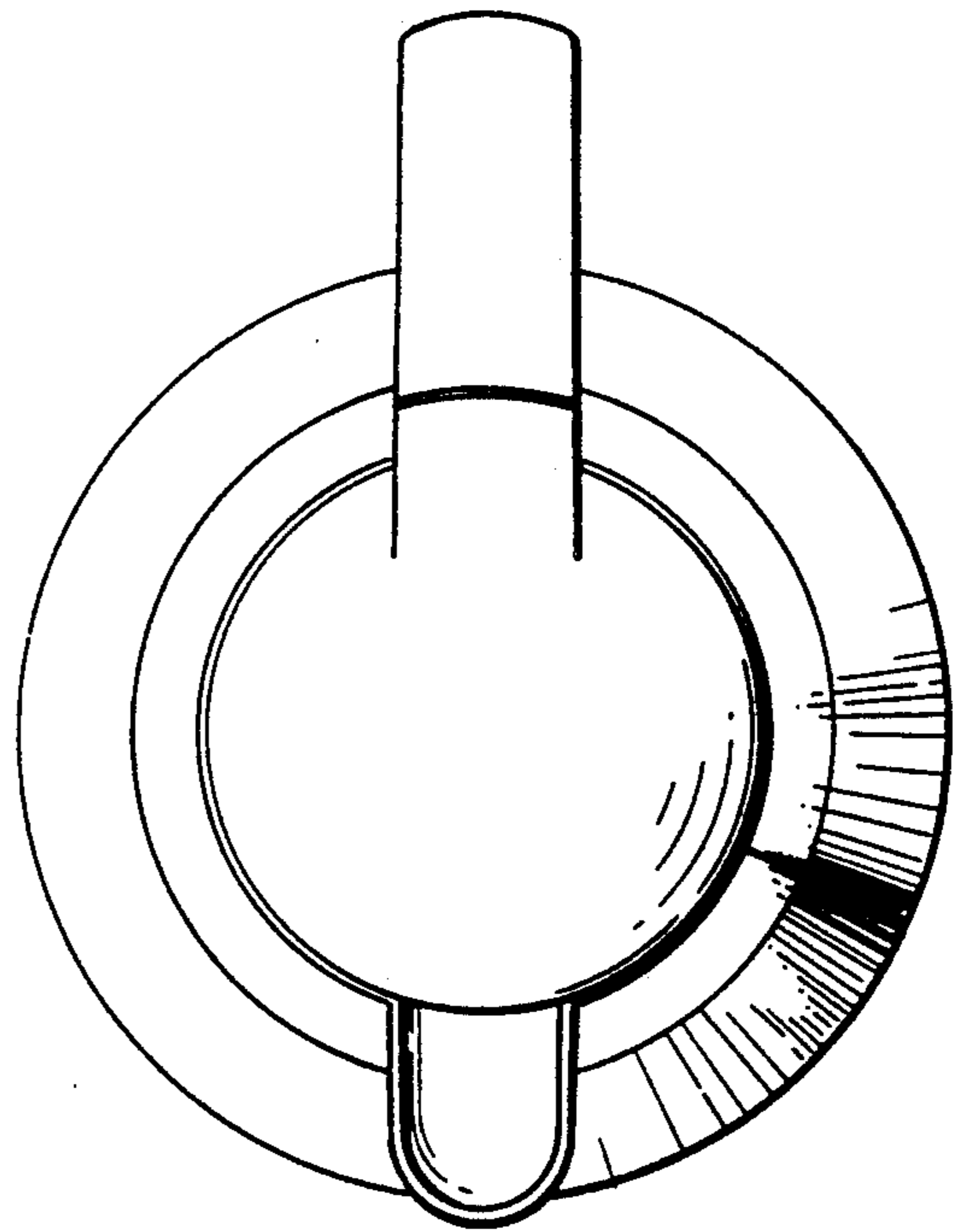

FIG. 5

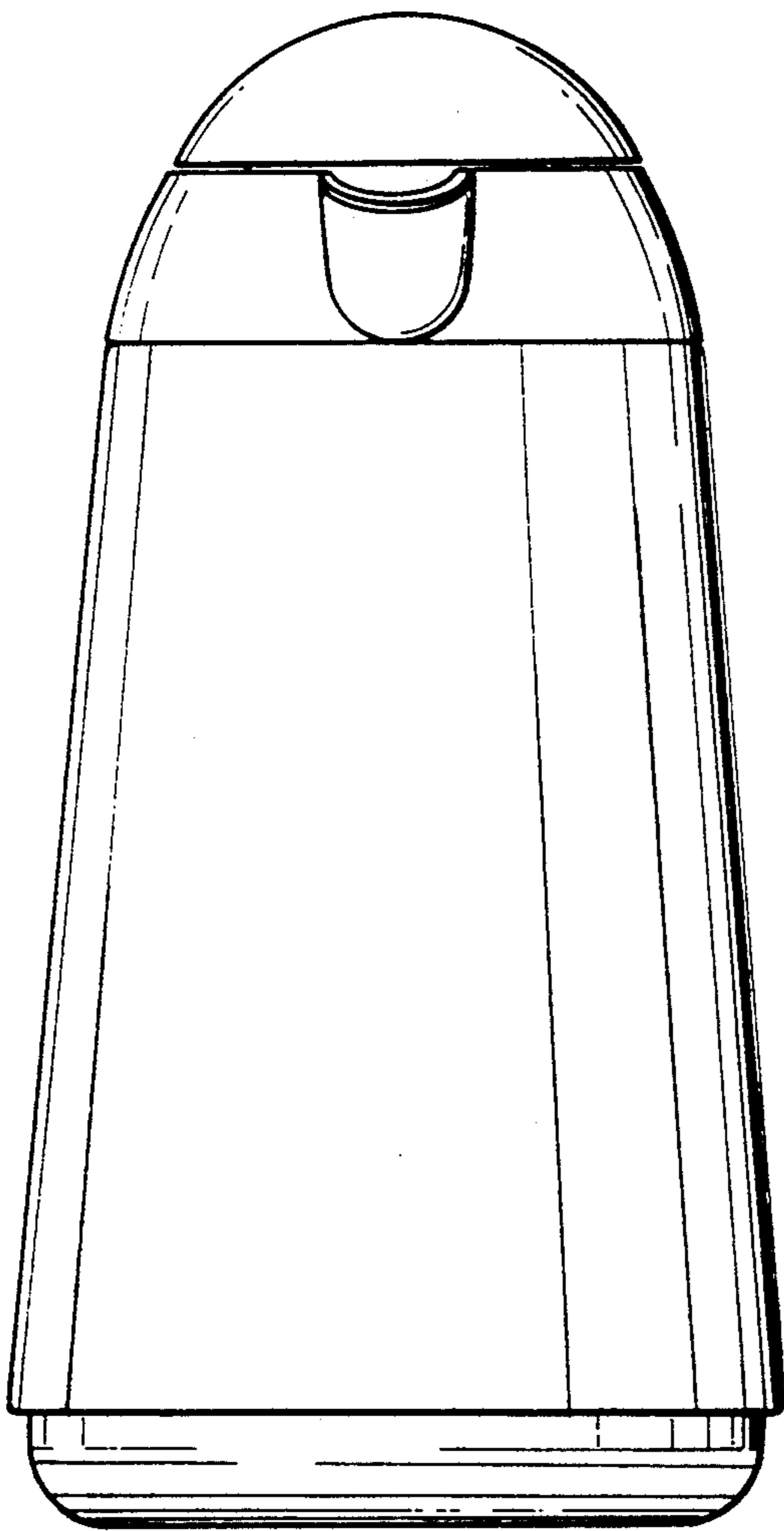

FIG. 6

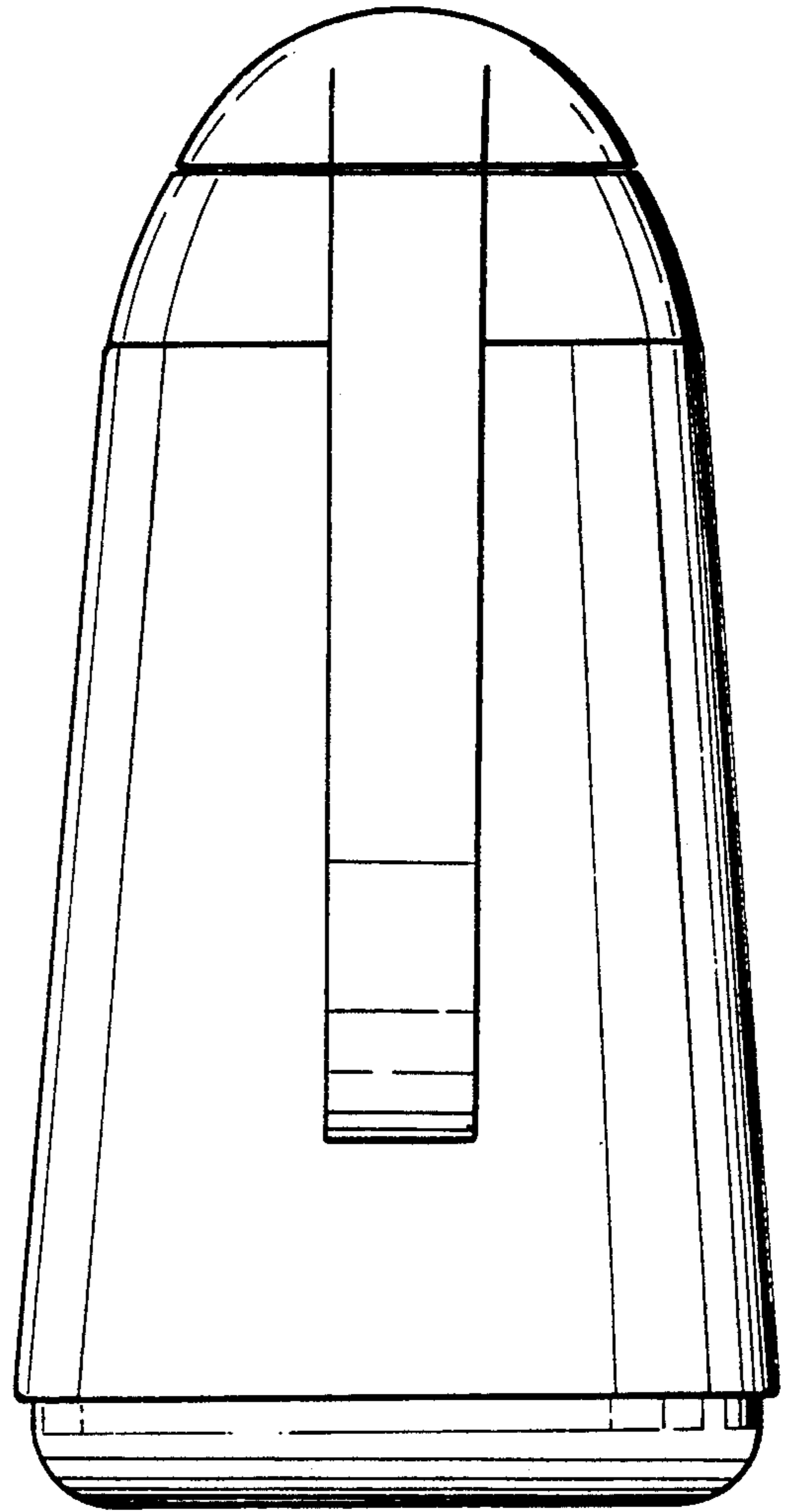

FIG. 7

UNITED STATES PATENT AND TRADEMARK OFFICE
CERTIFICATE OF CORRECTION

PATENT NO. : Des. 323,951
DATED : February 18, 1992
INVENTOR(S) : INOUE

It is certified that error appears in the above-identified patent and that said Letters Patent is hereby corrected as shown below:

On the cover page, item [30], change "1-4230" to --63-
51214--.

Signed and Sealed this
Sixth Day of July, 1993

Attest:



MICHAEL K. KIRK

Attesting Officer

Acting Commissioner of Patents and Trademarks