



US00D323939S

United States Patent [19]

[11] Patent Number: **Des. 323,939**

Mok

[45] Date of Patent: **** Feb. 18, 1992**

[54] **WRIST POUCH**

1,184,311	5/1916	Boch	224/222
1,409,866	3/1922	Kendall	224/222
1,728,365	9/1929	Root et al.	224/222

[76] Inventor: **Linda B. Mok, 1533 S. Kelton Ave., Los Angeles, Calif. 90024**

FOREIGN PATENT DOCUMENTS

[**] Term: **14 Years**

3242145 5/1984 Fed. Rep. of Germany D3/106

[21] Appl. No.: **403,332**

Primary Examiner—A. Hugo Word
Assistant Examiner—M. N. Pandozzi
Attorney, Agent, or Firm—Louis A. Mok

[22] Filed: **Sep. 6, 1989**

[52] U.S. Cl. **D3/106; D3/100; D3/52**

[57] **CLAIM**

[58] **Field of Search** D3/100-106, D3/62, 40, 34, 42, 56; 224/208, 240, 218, 219, 221, 252, 226, 901, 148, 222, 227, 228; 383/901, 66; 150/131; D7/620; 273/189 R; 190/100, 119

The ornamental design for a wrist pouch, as shown and described.

DESCRIPTION

[56] **References Cited**

U.S. PATENT DOCUMENTS

214,823	9/1879	Hopkins	224/218
D. 270,784	10/1983	Forrester	D3/34 X
D. 288,743	3/1987	Taylor	D3/106
D. 291,044	7/1987	Canning	D7/620
781,056	1/1905	Duncan	224/222

FIG. 1 is a front, top, right perspective view of a wrist pouch showing my new design;
FIG. 2 is a front elevational view thereof;
FIG. 3 is a rear elevational view thereof;
FIG. 4 is a top plan view thereof;
FIG. 5 is a right side elevational view thereof;
FIG. 6 is a left side elevational view thereof; and
FIG. 7 is a bottom plan view thereof.

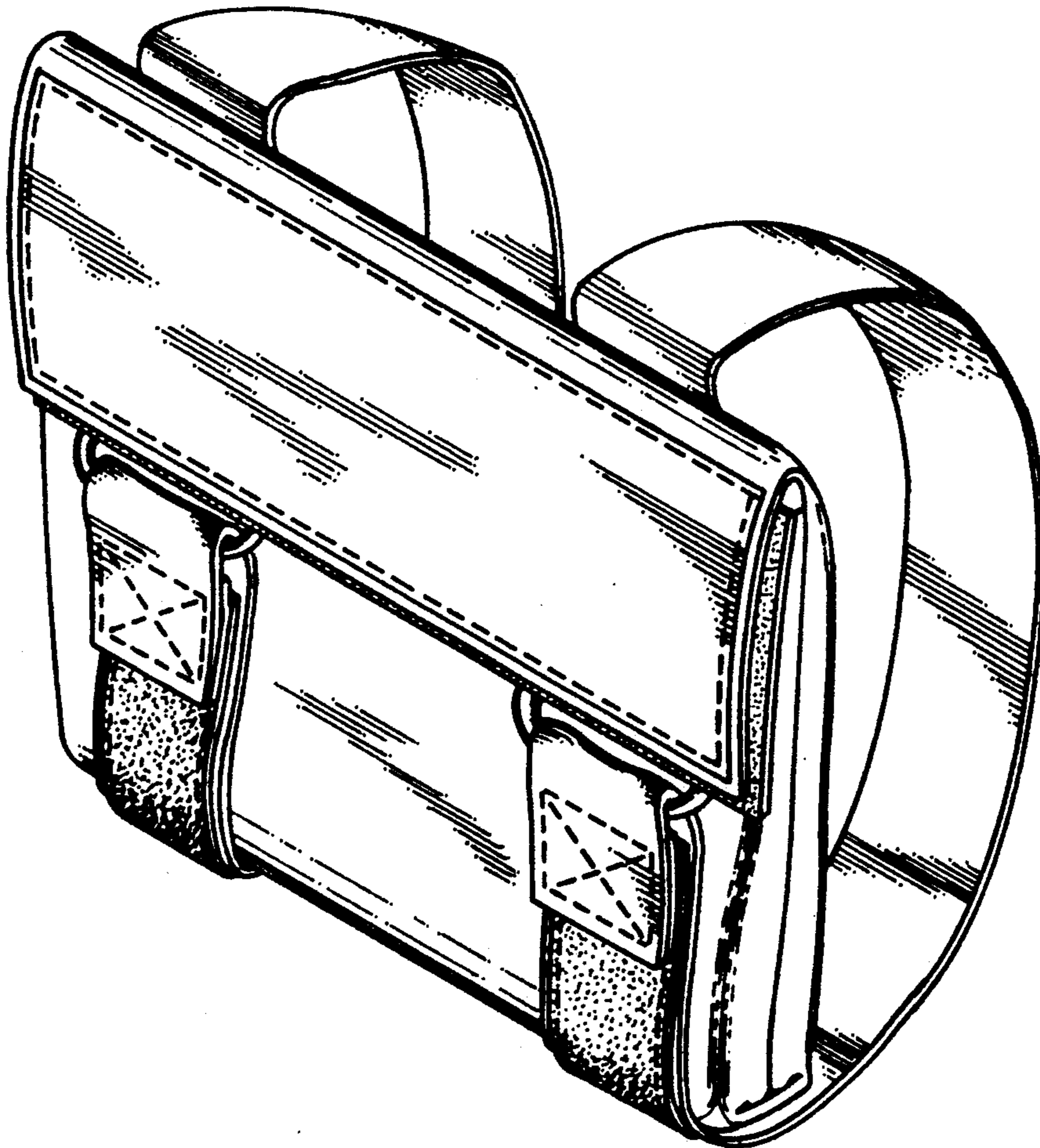

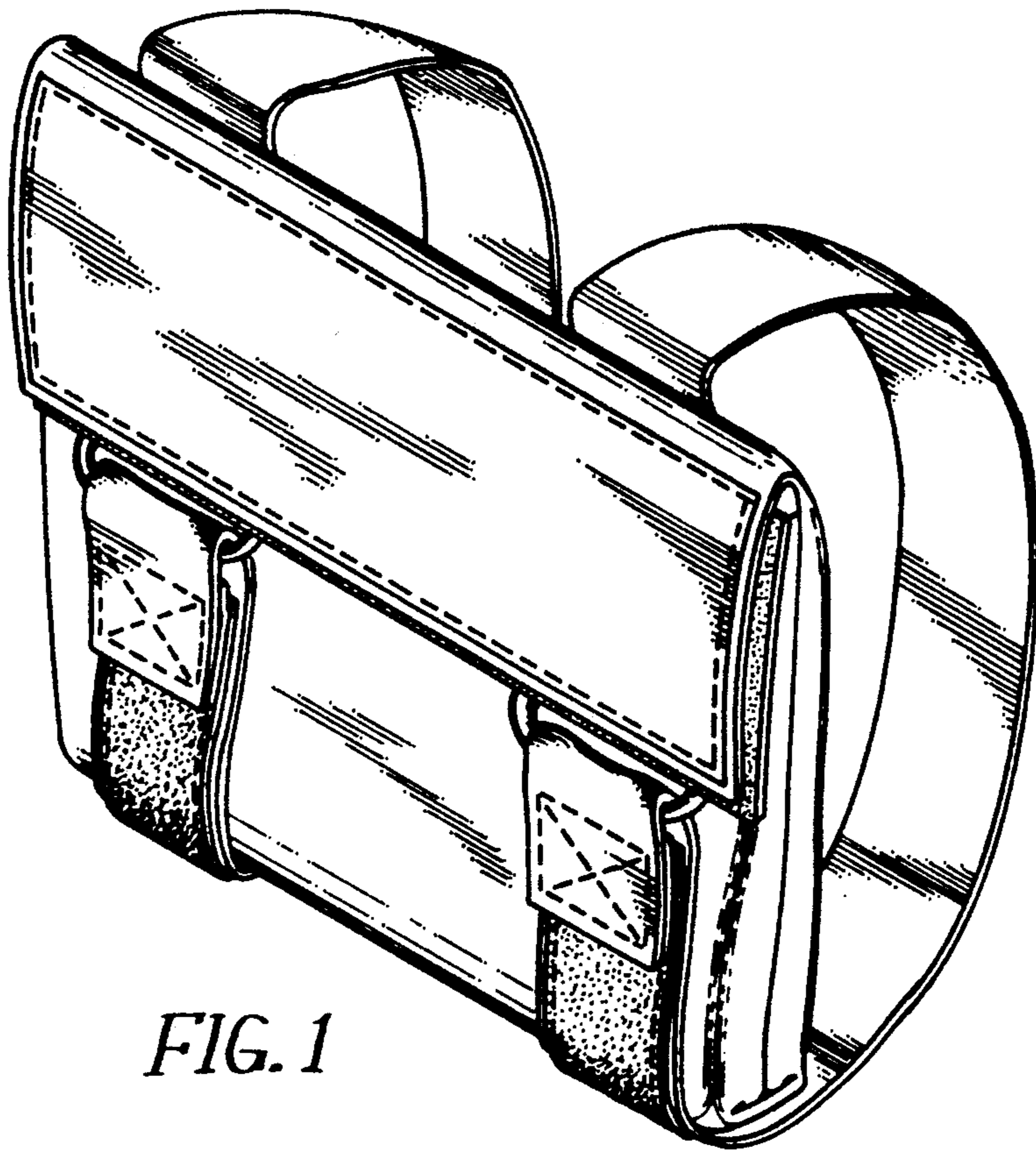

FIG. 1

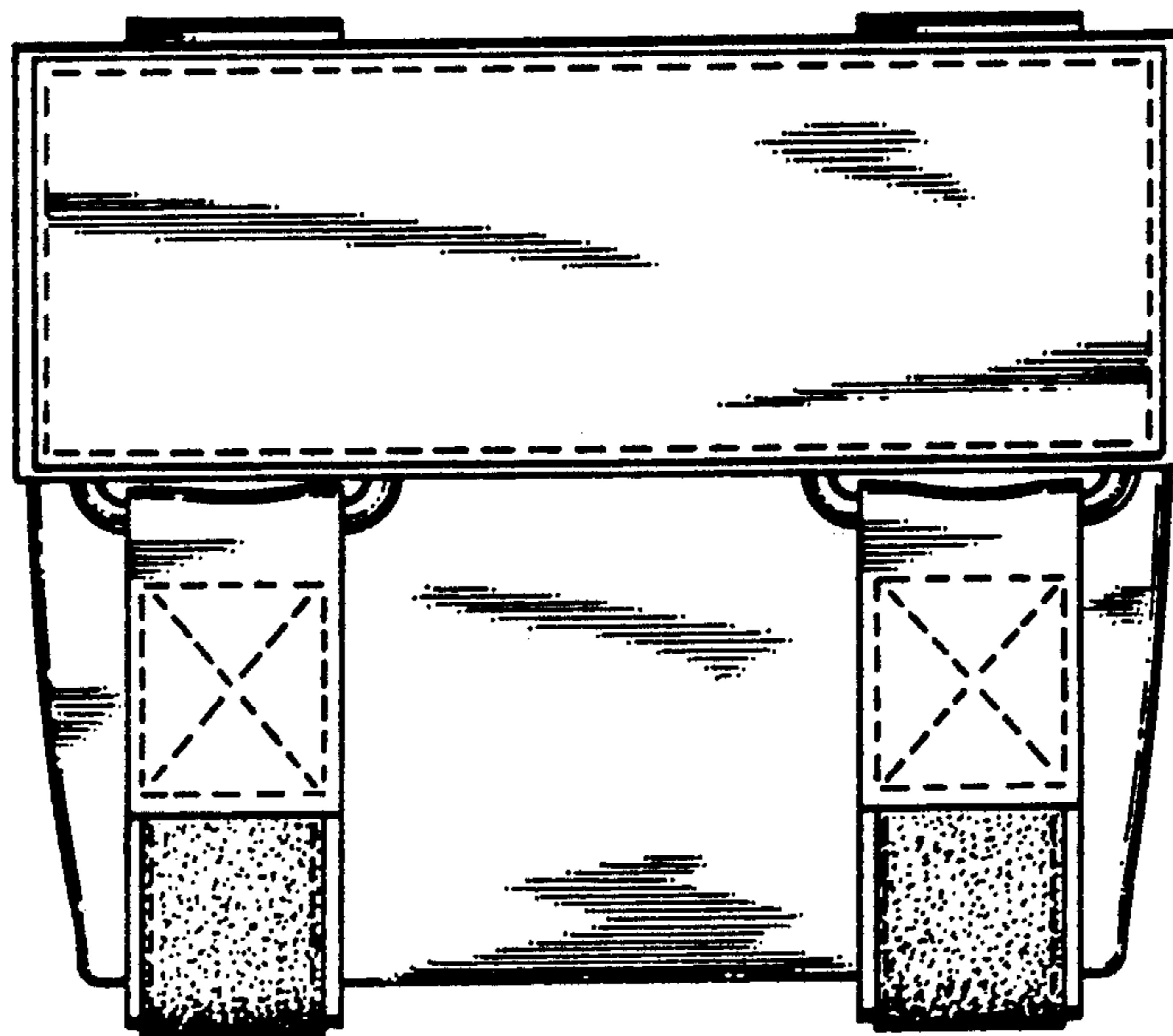

FIG. 2

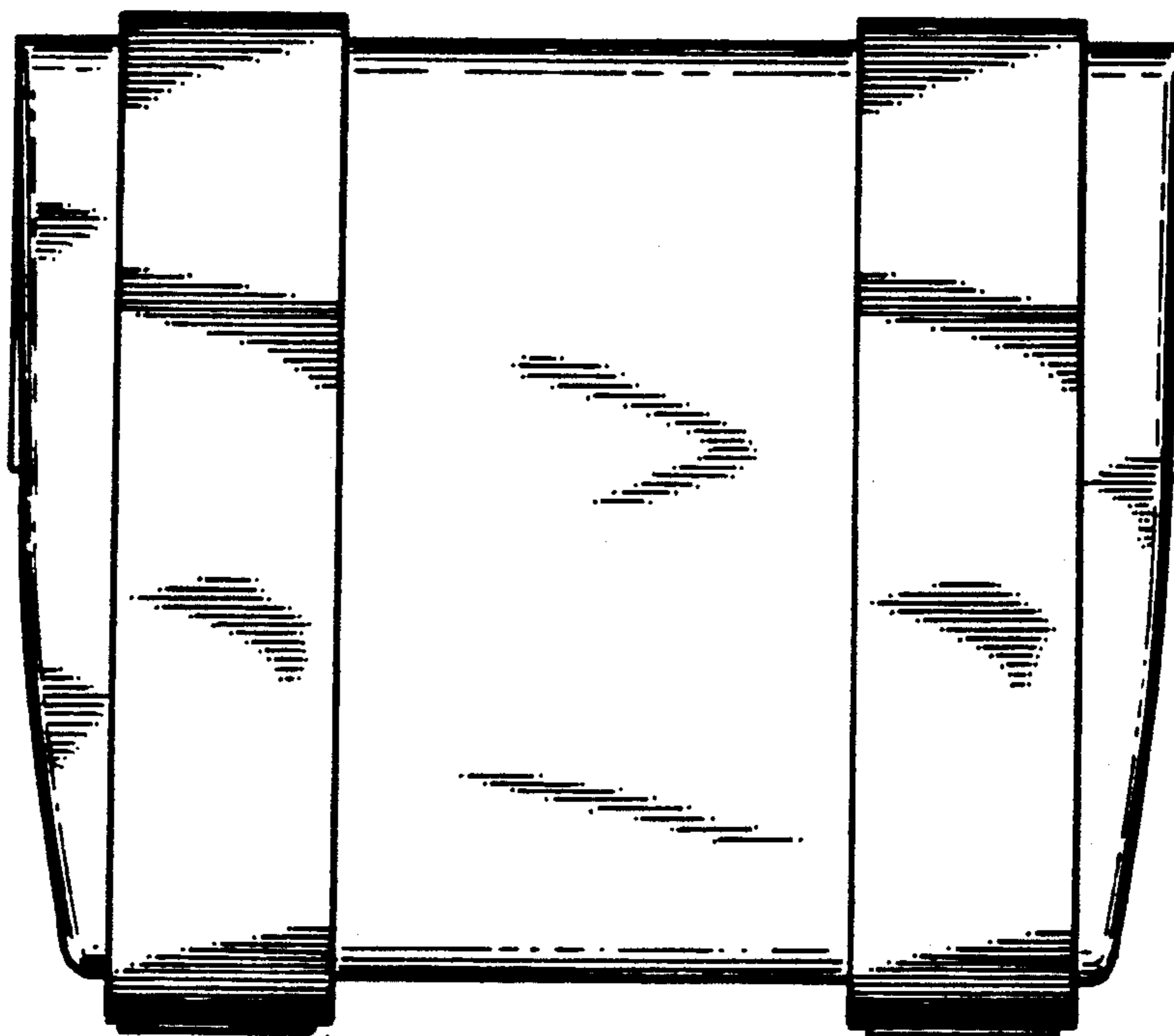

FIG. 3

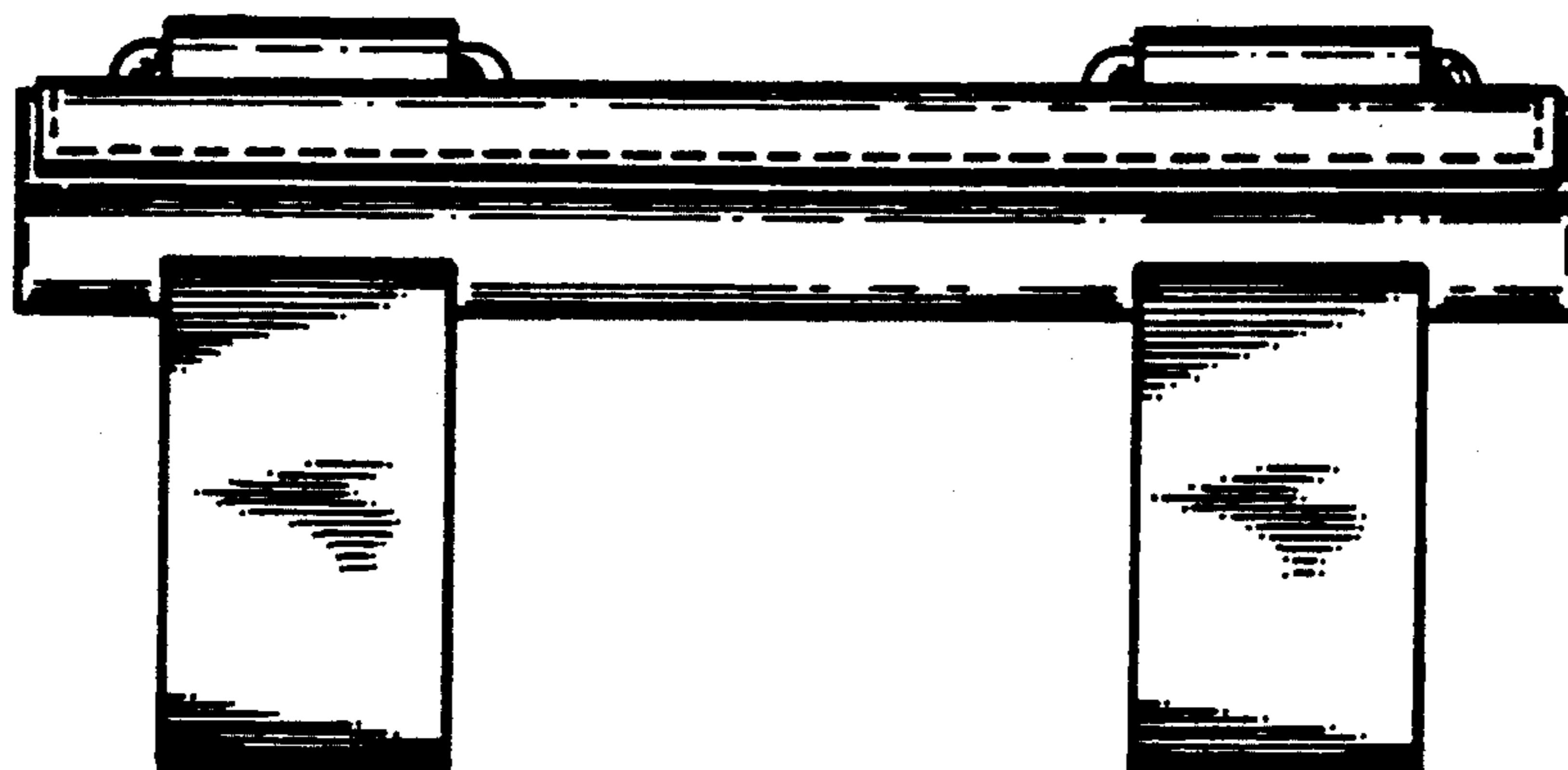

FIG. 4

FIG. 5

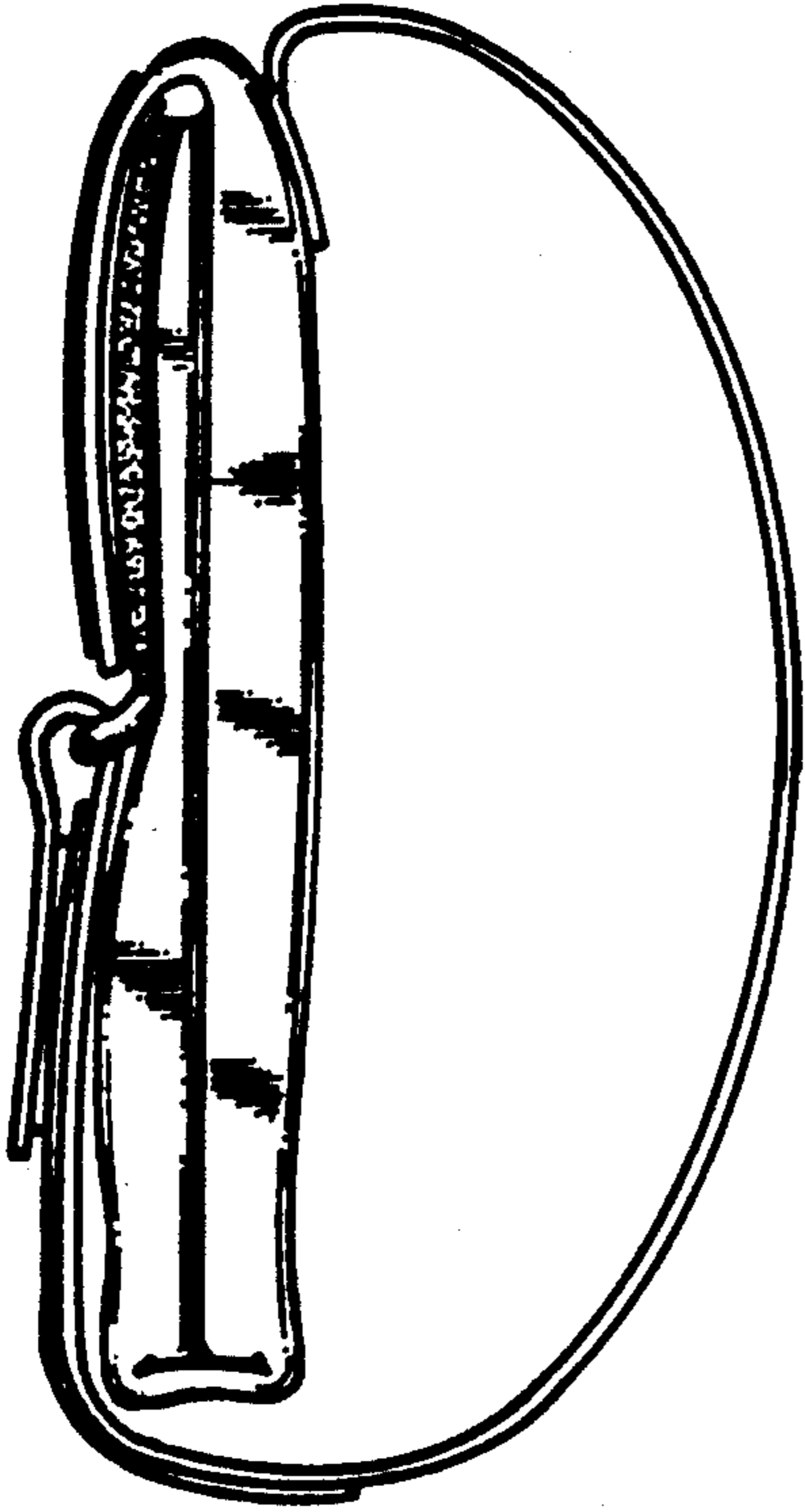

FIG. 6

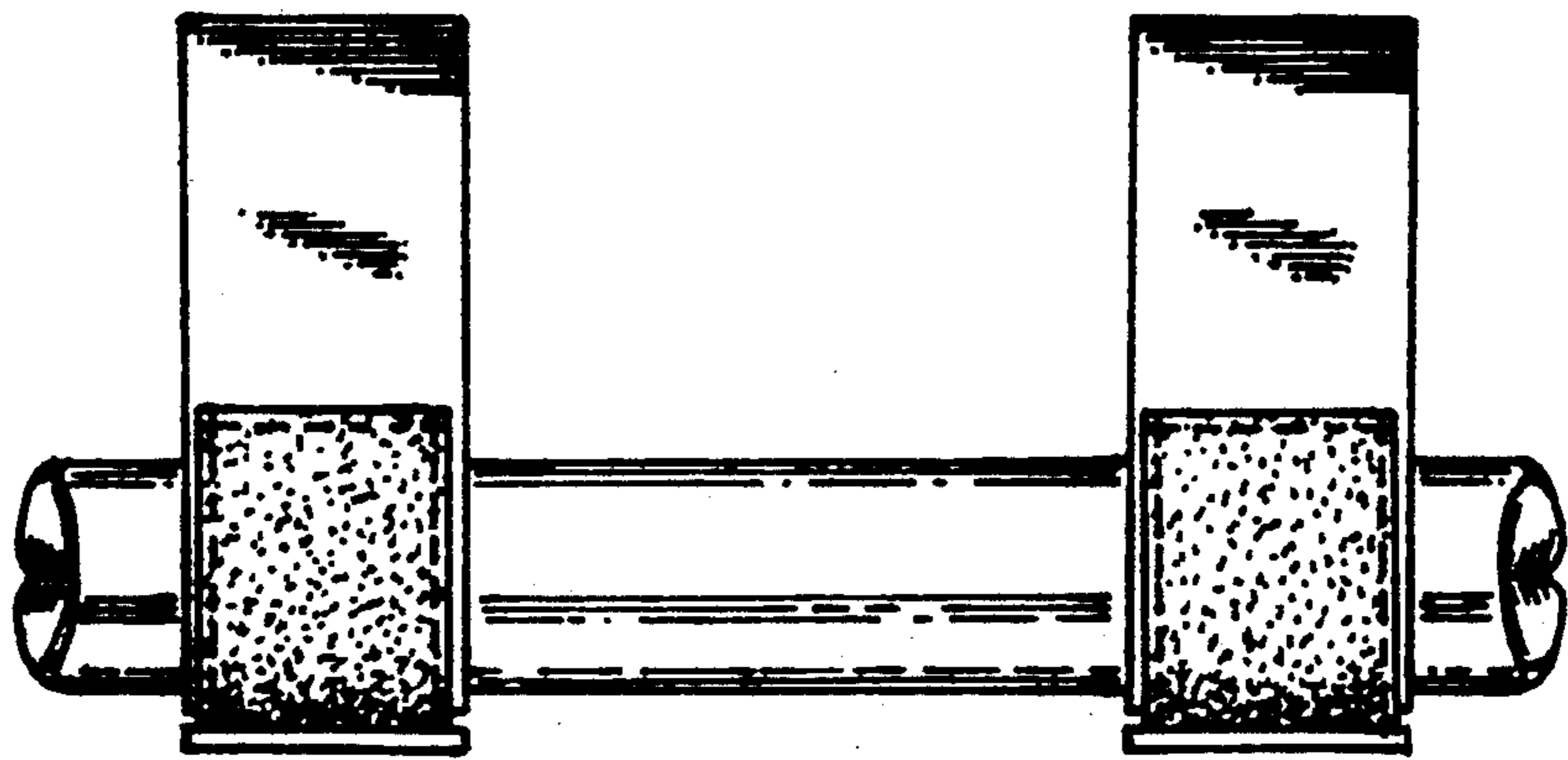
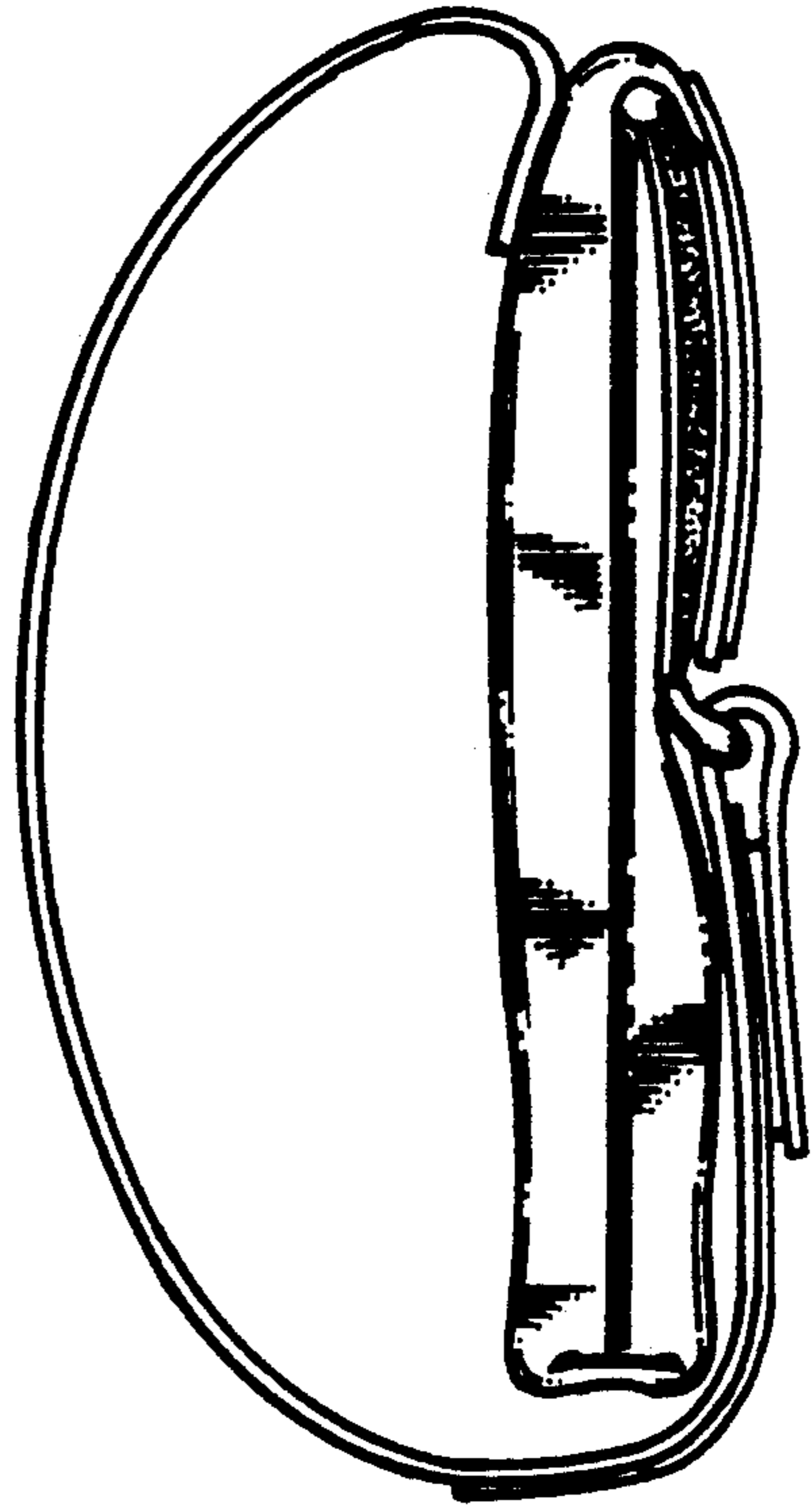

FIG. 7