



US00D323821S

United States Patent [19]

[11] Patent Number: **Des. 323,821**

Ishikawa et al.

[45] Date of Patent: **** Feb. 11, 1992**

[54] **FACSIMILE**

D. 304,874 11/1989 Saegusa et al. D14/118
D. 313,992 1/1991 Suge D14/118

[75] Inventors: **Shigetoshi Ishikawa, Itami; Tadakazu Ogiri, Takatsuki; Hiroyuki Tanaka, Yamatokoriyama, all of Japan**

OTHER PUBLICATIONS

Modern Office Technology, May 1989, p. BC4, bottom—Citifax Starblaster II.

[73] Assignee: **Mita Industrial Co., Ltd., Osaka, Japan**

Primary Examiner—Theodore M. Shooman
Attorney, Agent, or Firm—Beveridge, DeGrandi & Weilacher

[**] Term: **14 Years**

[21] Appl. No.: **532,994**

[57] **CLAIM**

The ornamental design of a facsimile, as shown.

[22] Filed: **Jun. 4, 1990**

[30] **Foreign Application Priority Data**

DESCRIPTION

Dec. 8, 1989 [JP] Japan 1-44671

FIG. 1 is a front elevational view of a facsimile showing our new design;
FIG. 2 is a top plan view thereof;
FIG. 3 is a right side elevational view thereof;
FIG. 4 is a left side elevational view thereof;
FIG. 5 is a rear elevational view thereof;
FIG. 6 is a bottom plan view thereof; and
FIG. 7 is a top, front and right side perspective view thereof.

[52] U.S. Cl. **D14/118**

[58] Field of Search D14/107, 109, 118, 124, D14/217, 299; D18/36-37; 358/400-401

[56] **References Cited**

U.S. PATENT DOCUMENTS

D. 300,532 4/1989 Yoshihama D14/118
D. 301,878 6/1989 Noma D14/118

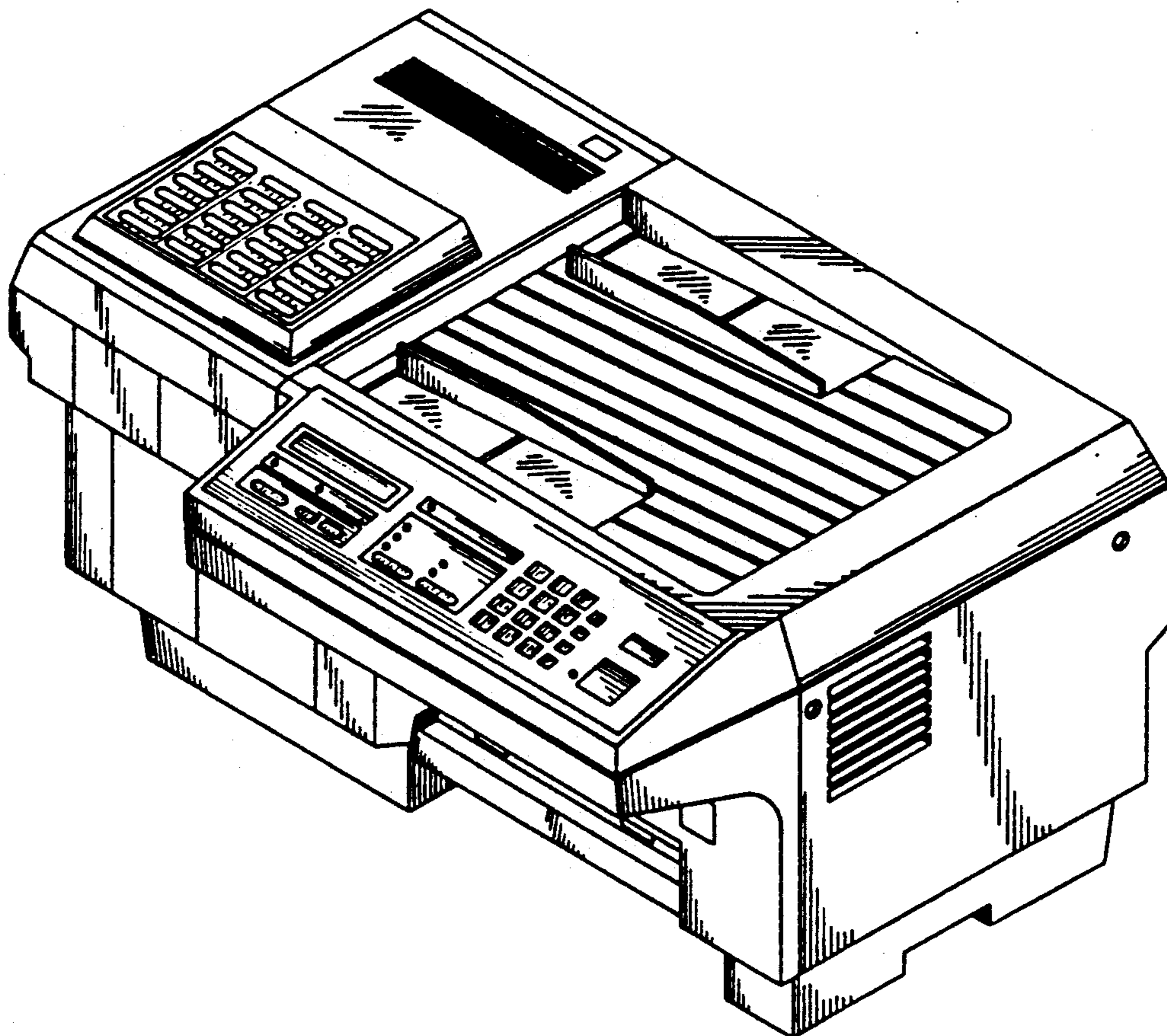

FIG. 1

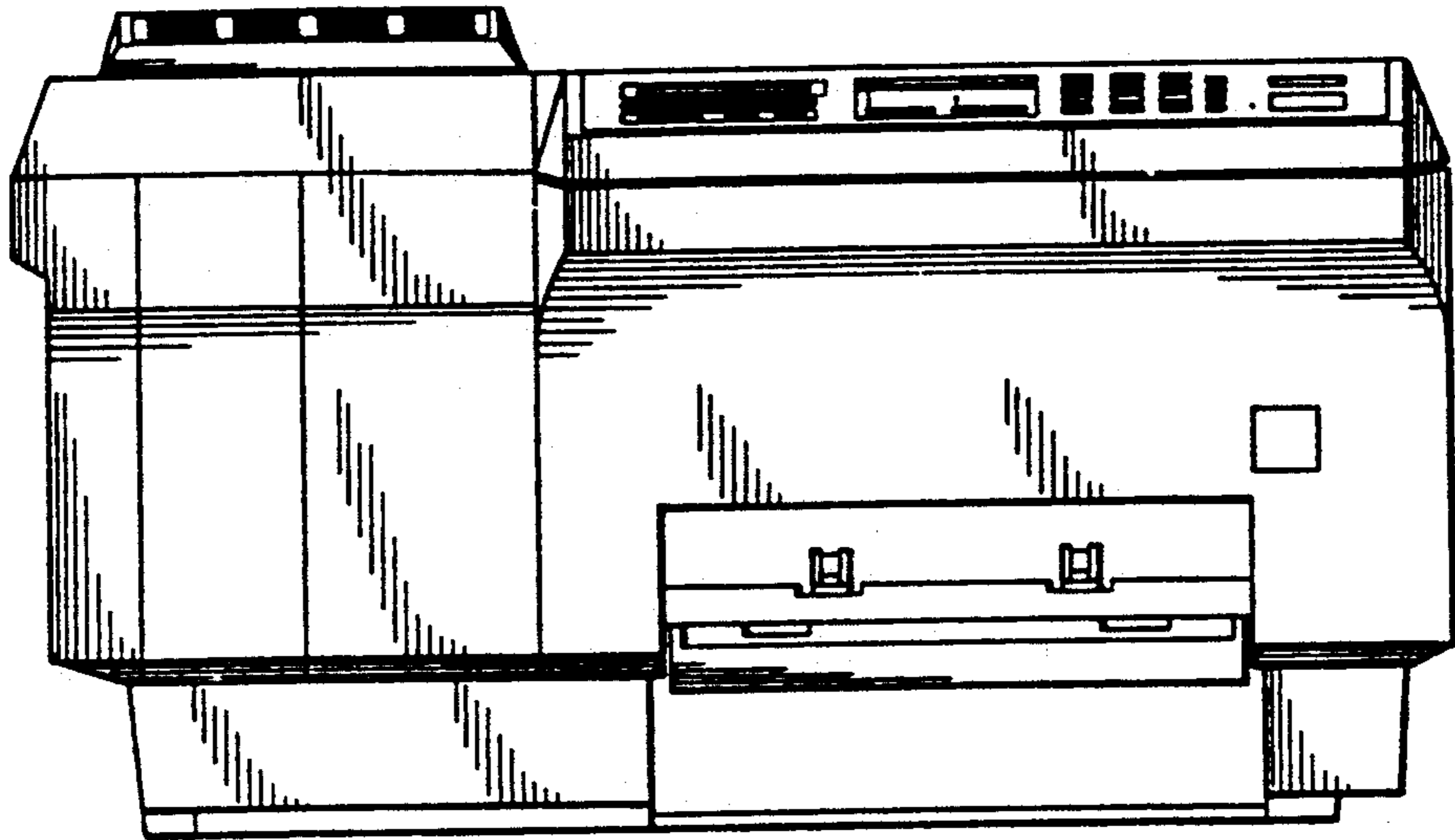

FIG. 2

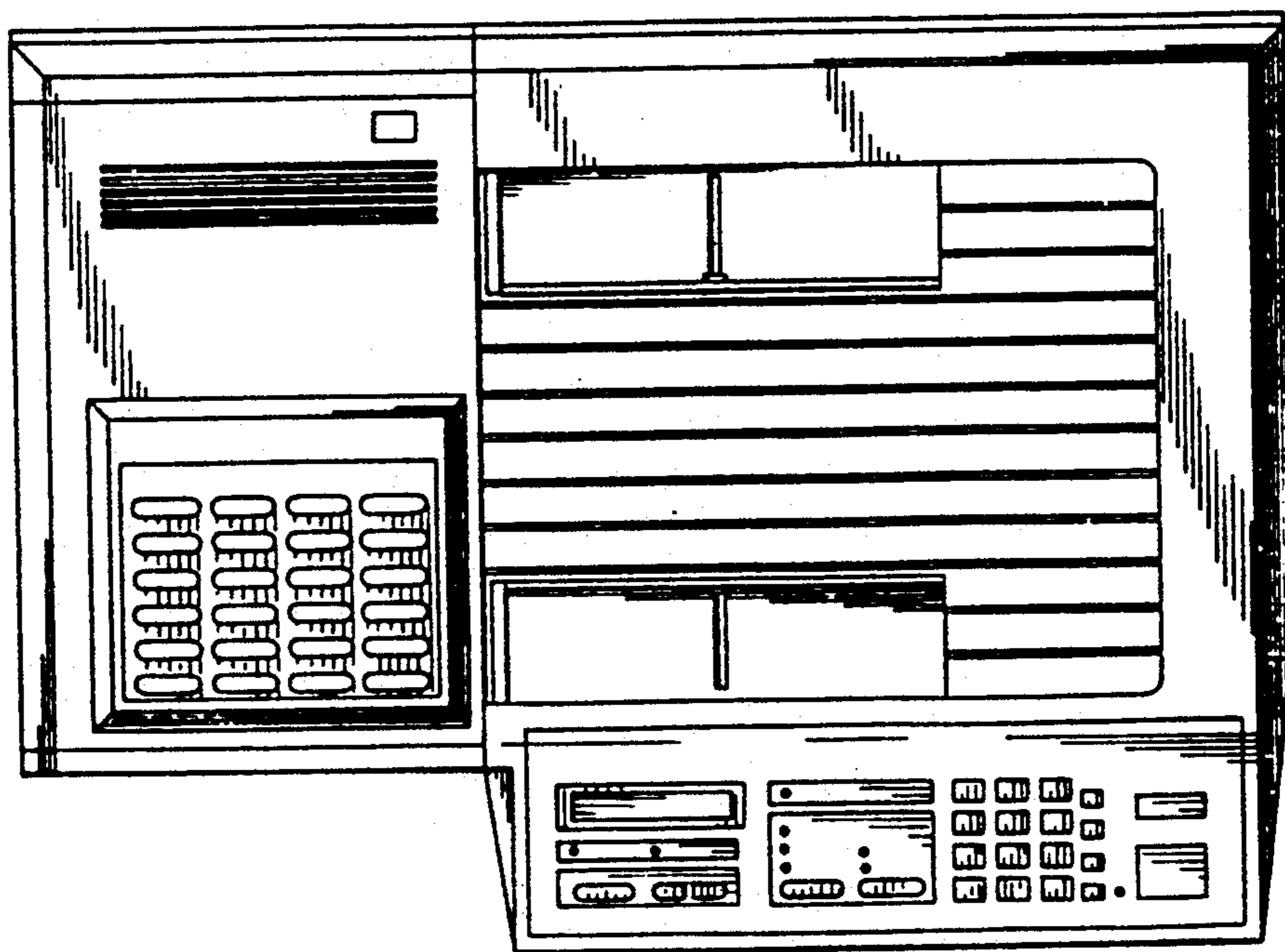

FIG. 3

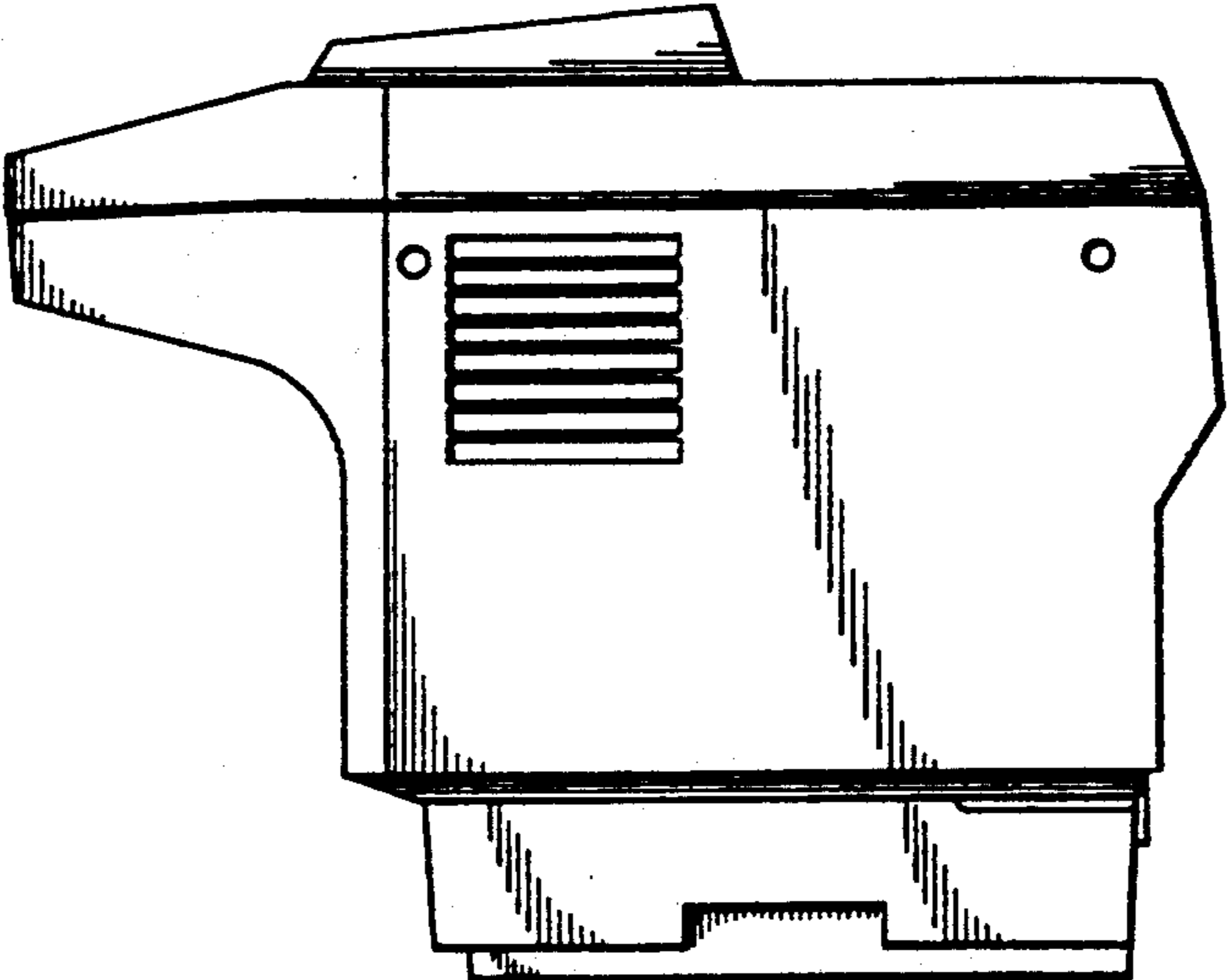

FIG. 4

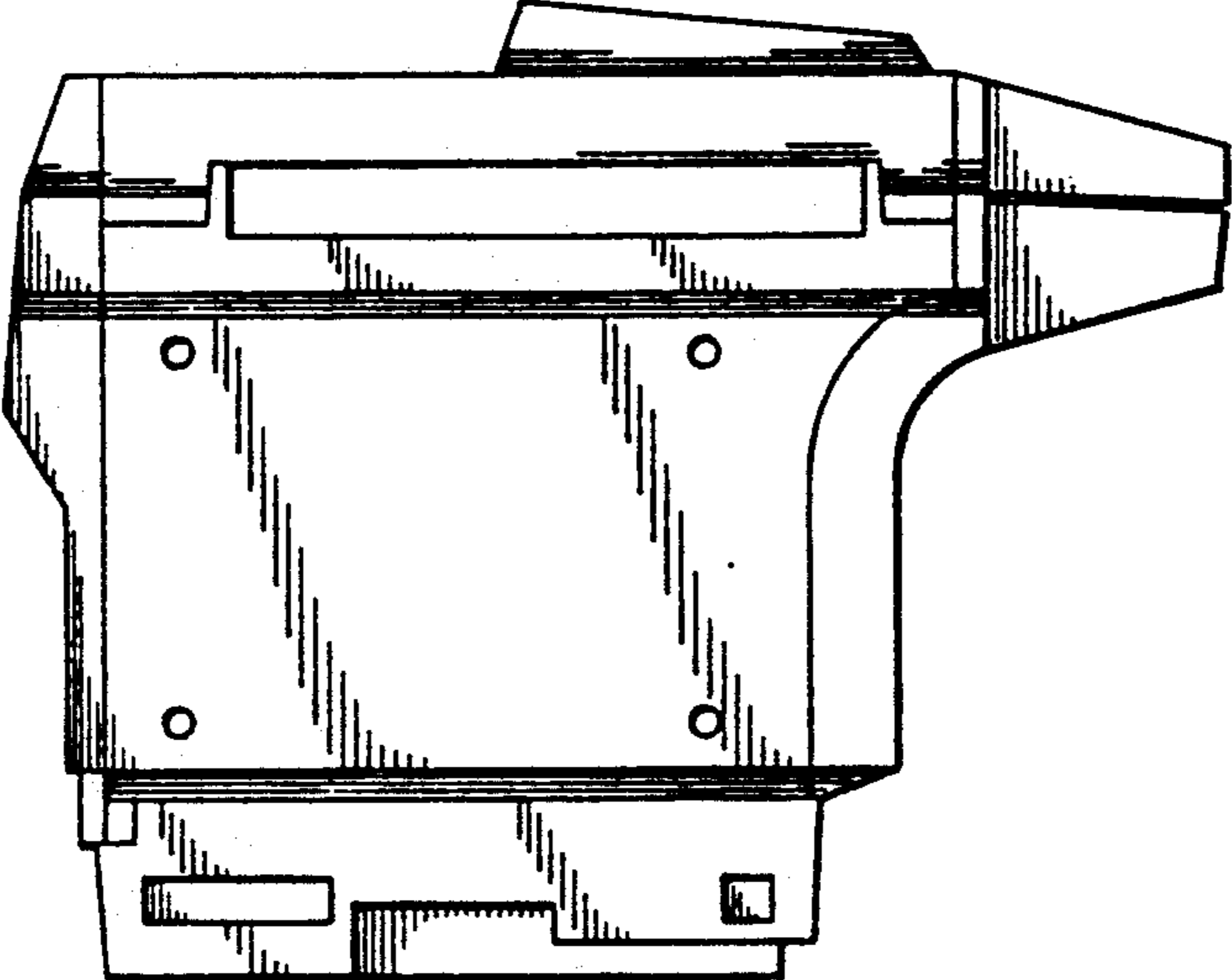

FIG. 5

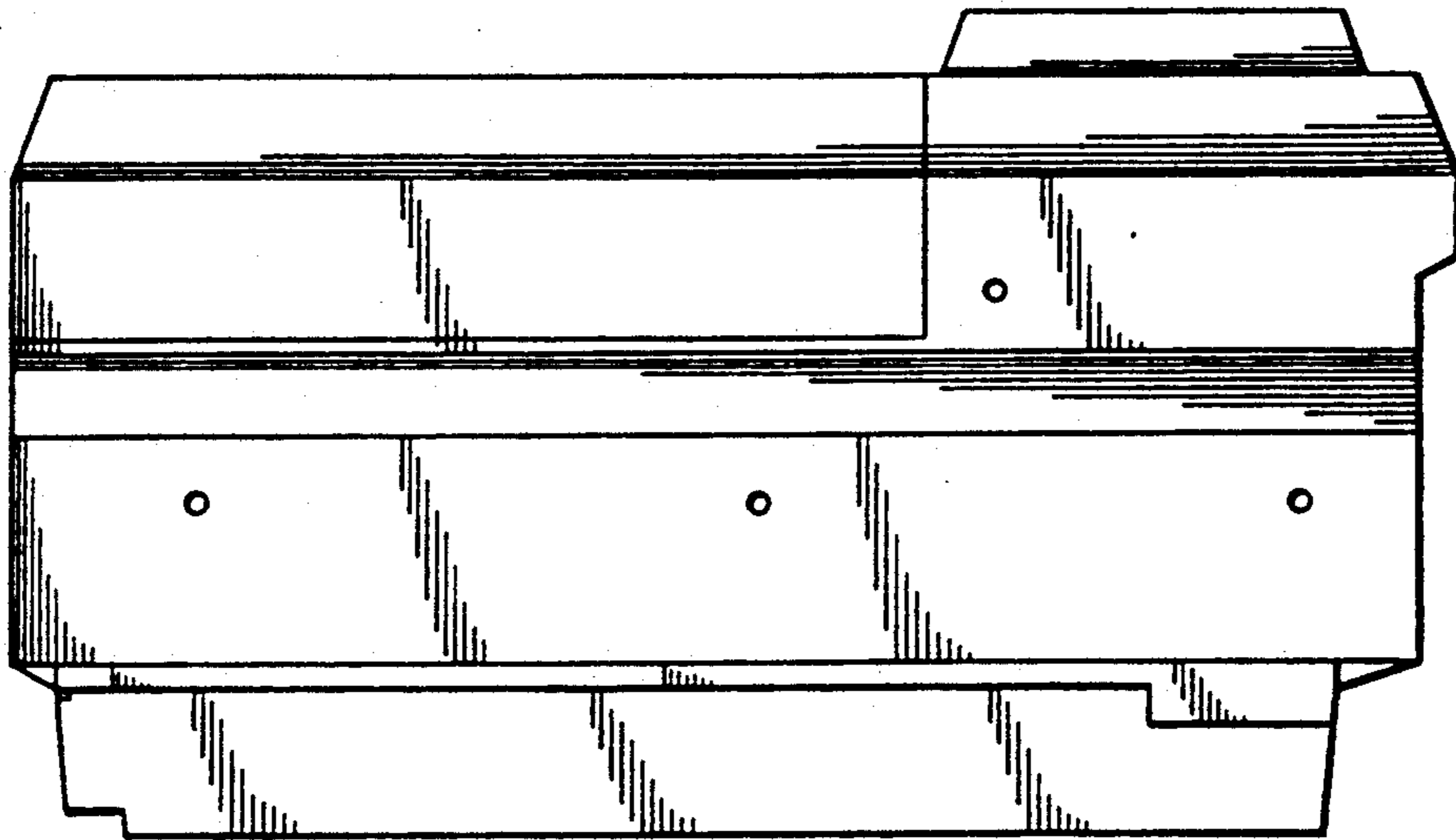

FIG. 6

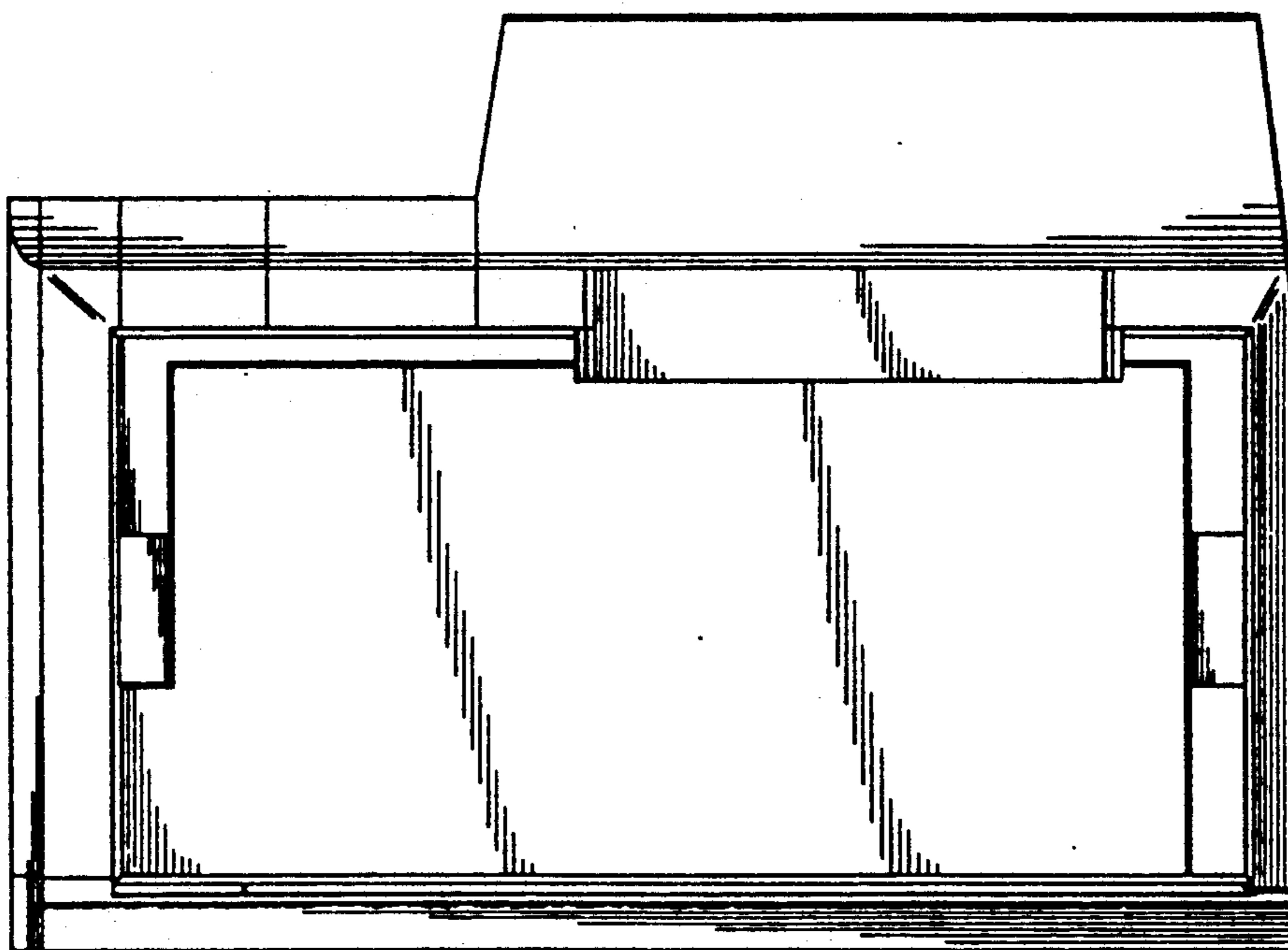

FIG. 7

