



US00D323710S

United States Patent [19]

[11] Patent Number: **Des. 323,710**

Kasai et al.

[45] Date of Patent: **** Feb. 4, 1992**

[54] BLOOD COLLECTING TUBE HOLDER

[75] Inventors: **Masaaki Kasai; Sakae Yamazaki,**
both of Yamanashi; **Kazuhisa Senshu,**
Fuji, all of Japan

[73] Assignee: **Terumo Kabushiki Kaisha,** Tokyo,
Japan

[**] Term: **14 Years**

[21] Appl. No.: **213,976**

[22] Filed: **Jun. 29, 1988**

[52] U.S. Cl. **D24/130**

[58] Field of Search **D24/24; 128/760, 763,**
128/764, 766; 604/241, 240, 242, 263, 192, 198,
415, 403; 206/365

[56] References Cited

U.S. PATENT DOCUMENTS

D. 214,147	5/1969	Ritsi	D9/402	X
D. 233,738	11/1974	Latorre	D9/402	
D. 307,796	5/1990	Hanifl et al.	D24/25	
3,329,146	7/1967	Waldman, Jr.	D24/24	X
3,494,352	2/1970	Russo et al.	128/764	
3,874,367	4/1975	Ayres	128/766	
4,617,941	10/1986	Ichikawa et al.	128/765	

4,679,571	7/1987	Frankel et al.	128/764	
4,788,986	12/1988	Harris	604/242	X
4,886,072	12/1989	Percarpio et al.	128/763	
4,892,525	1/1990	Hermann, Jr. et al.	604/192	X

Primary Examiner—A. Hugo Word
Assistant Examiner—Doris V. Coles
Attorney, Agent, or Firm—Frishauf, Holtz, Goodman & Woodward

[57] CLAIM

The ornamental design for a blood collecting tube holder, as shown and described.

DESCRIPTION

FIG. 1 is a front elevational view of a blood collecting tube holder showing our new design;
FIG. 2 is a left side elevational view thereof, the right side being a mirror image of the left;
FIG. 3 is a rear elevational view thereof;
FIG. 4 is a top plan view thereof;
FIG. 5 is a bottom plan view thereof;
FIG. 6 is an end view taken on line 6—6' in FIG. 1;
FIG. 7 is a sectional view taken on line 7—7' in FIG. 1; and
FIG. 8 is a front elevational view thereof, the broken line showing of a tube and a needle being environmental only and forming no part of the claimed design.

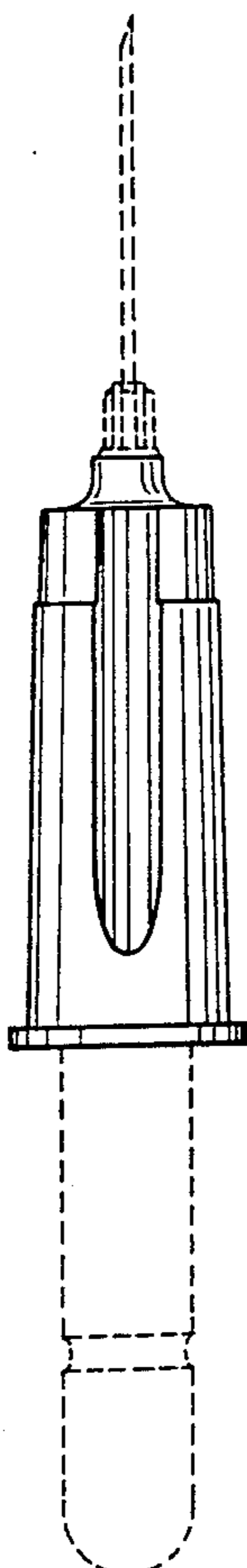

FIG. 1

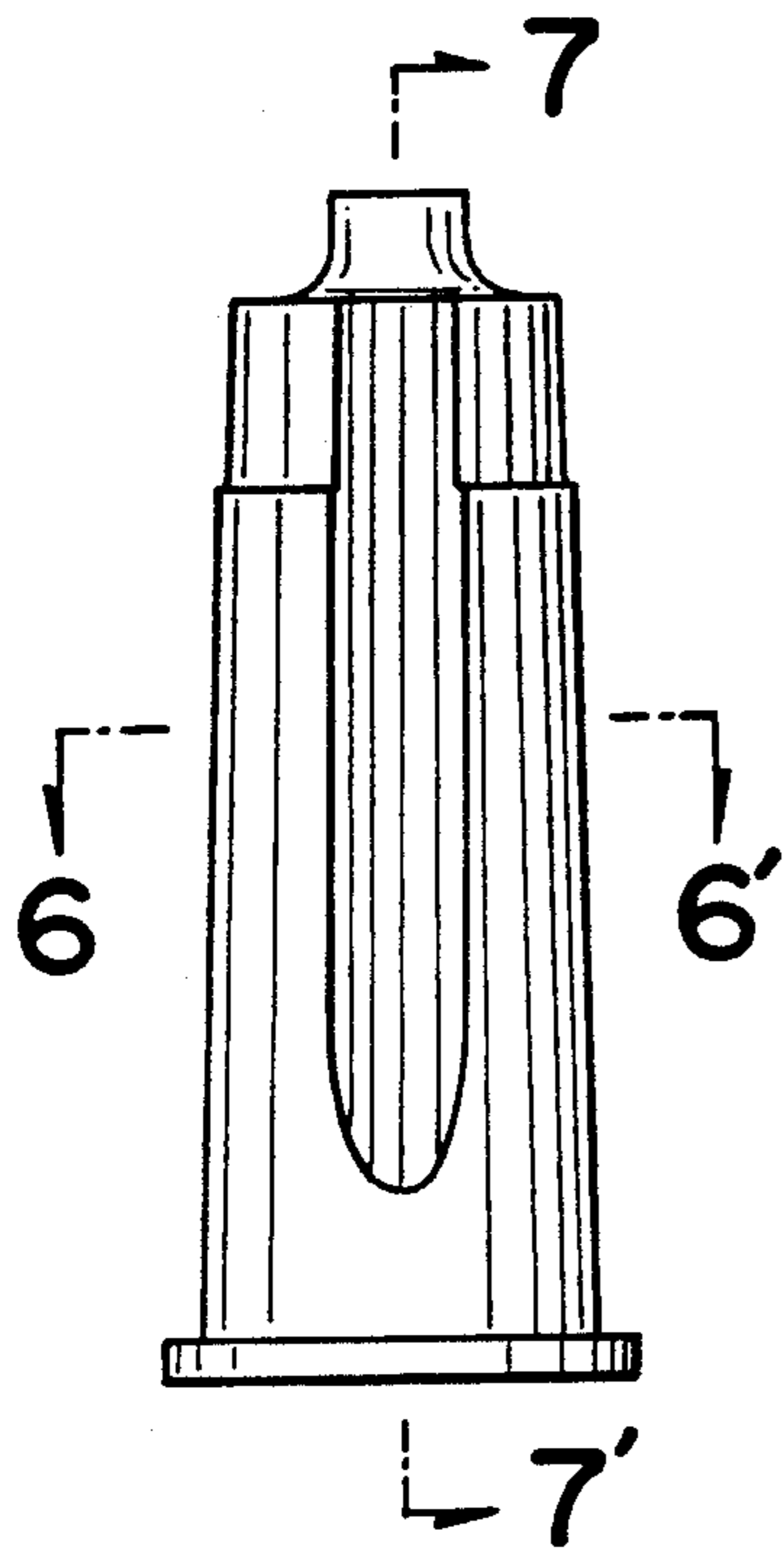

FIG. 2

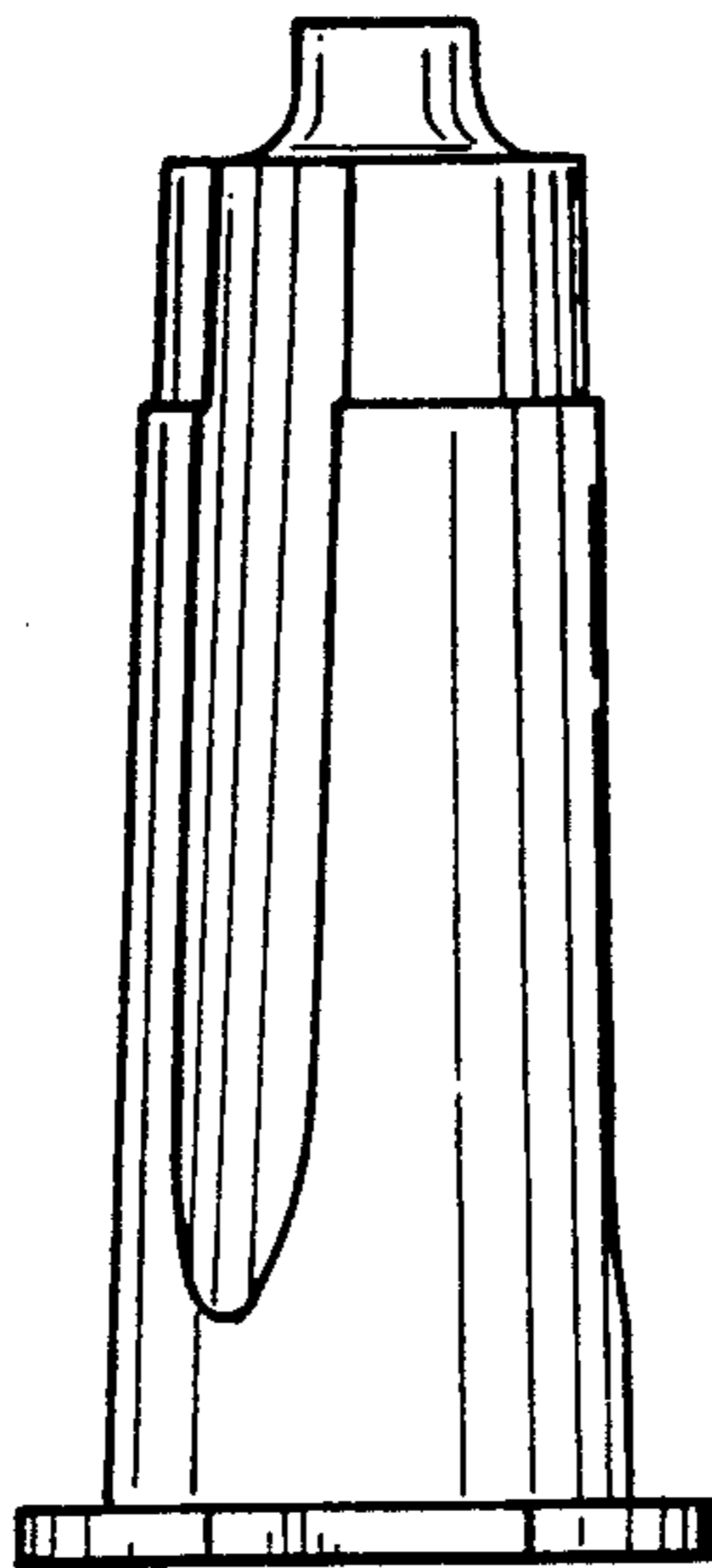

FIG. 3

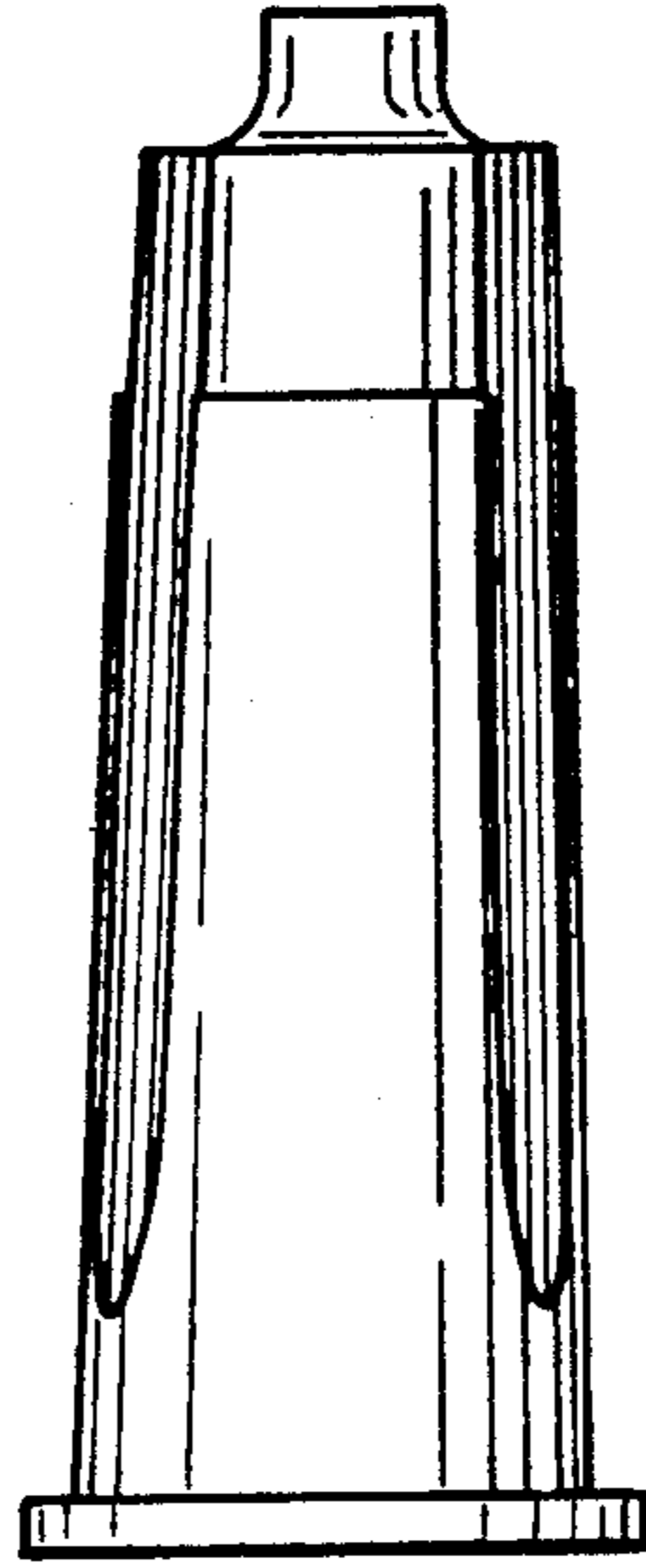

FIG. 8

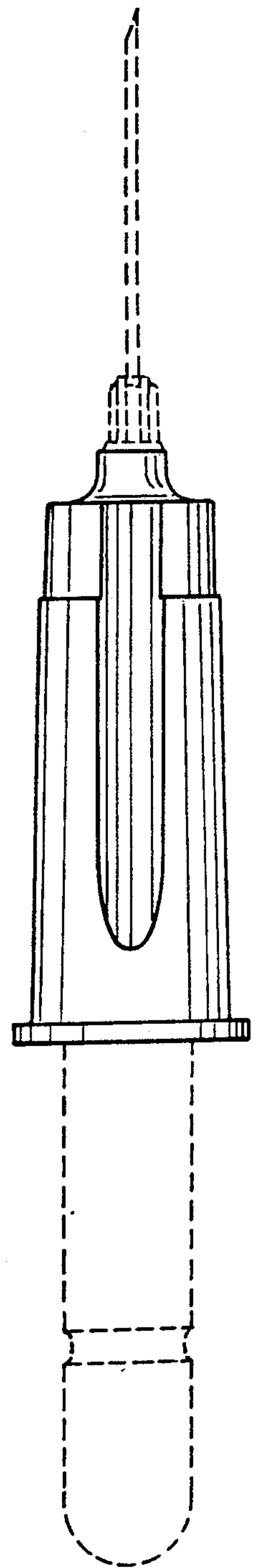

FIG. 4

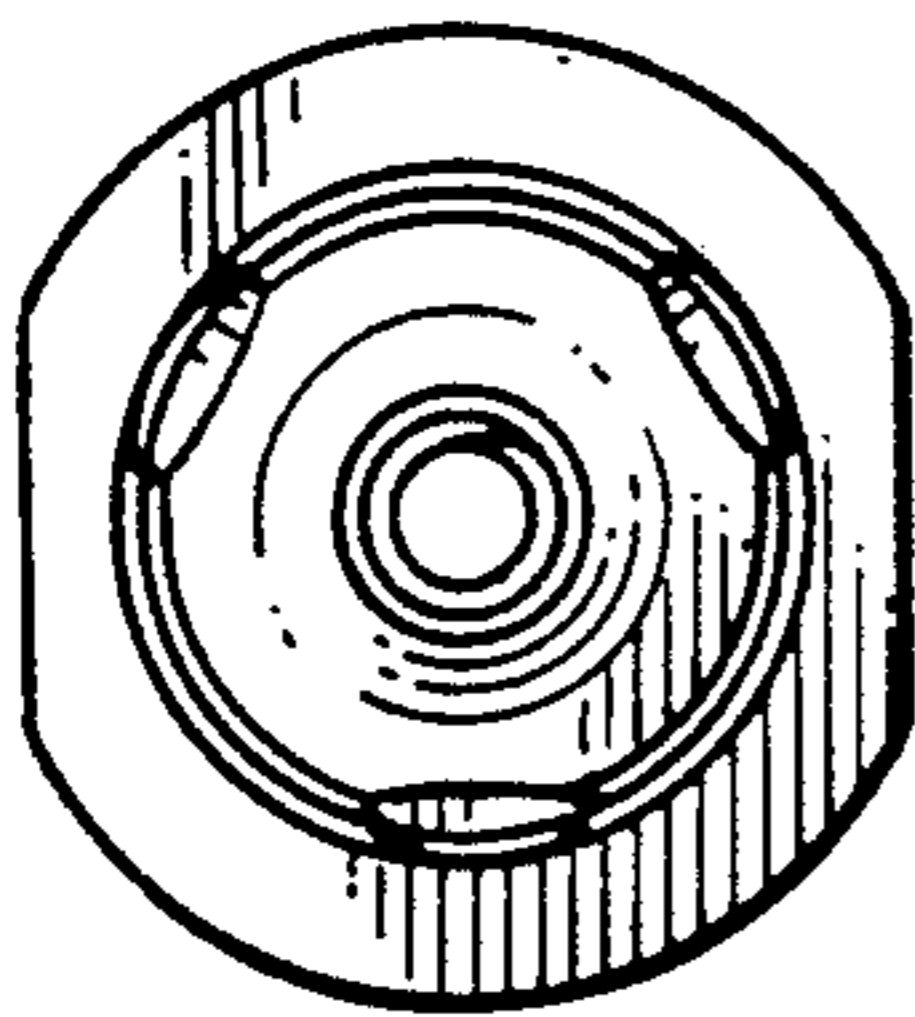

FIG. 6

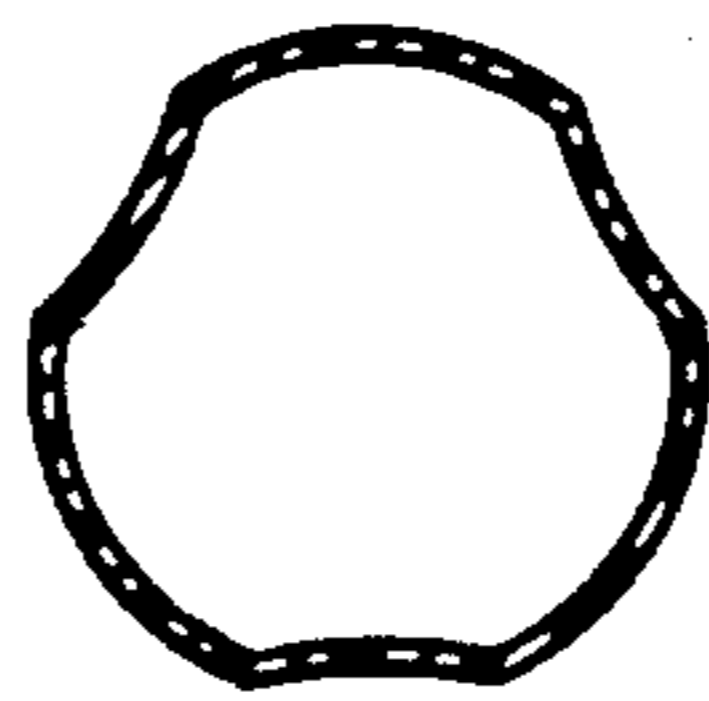

FIG. 5

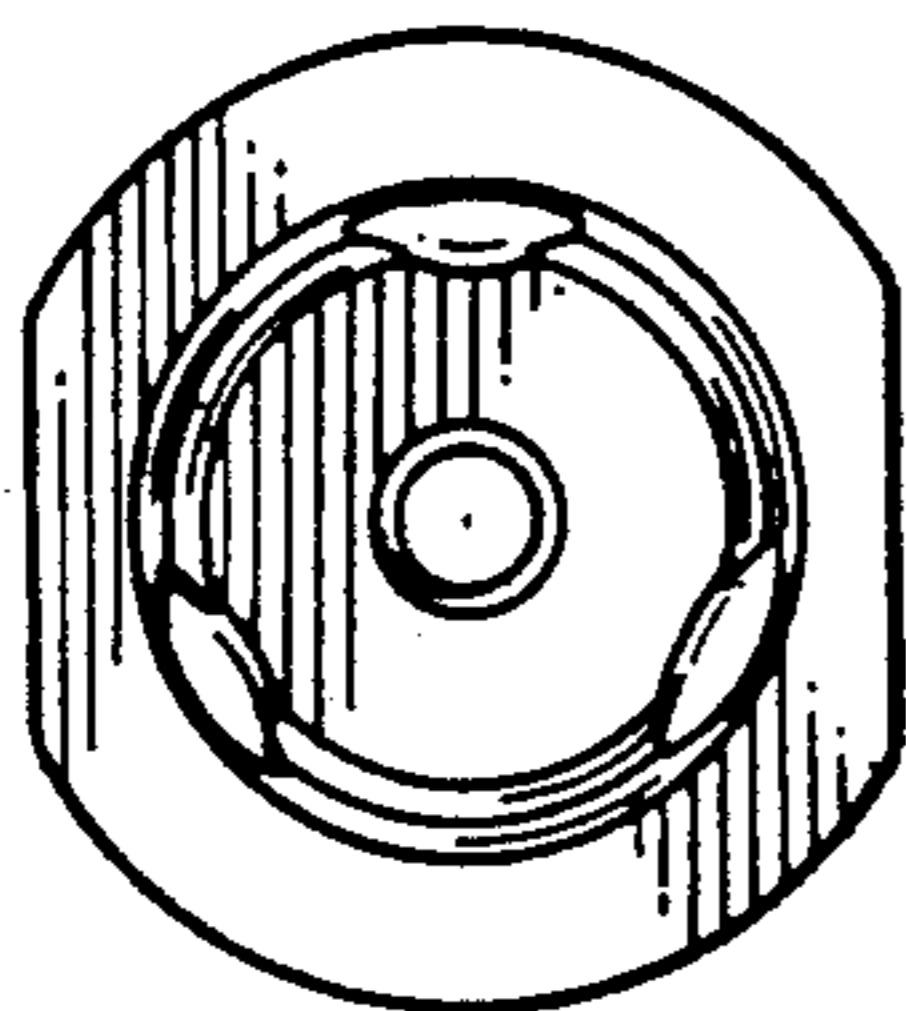

FIG. 7

