



US00D323582S

United States Patent [19]

[11] Patent Number: **Des. 323,582**

Volcani

[45] Date of Patent: **** Feb. 4, 1992**

[54] PORTABLE PERSONAL SUN SHADE

[76] Inventor: **Yanon Volcani**, 305 Bird Rock Ave.,
La Jolla, Calif. 92037

[**] Term: **14 Years**

[21] Appl. No.: **399,272**

[22] Filed: **Aug. 28, 1989**

[52] U.S. Cl. **D3/5**

[58] Field of Search **D3/5; 296/97.1, 97.5,
296/97.7; 160/370.2; D24/139; 135/90.20 R,
23; D12/189, 191; 350/631, 635, 636;
138/DIG. 8**

[56] References Cited

U.S. PATENT DOCUMENTS

- D. 185,815 8/1959 Starrett .
- D. 220,991 6/1971 Riley .
- D. 255,958 7/1980 Browning .
- D. 265,862 8/1982 Caldwell .
- 1,224,431 5/1917 Vorst .
- 4,852,564 8/1989 Sheridan et al. 138/DIG. 8

FOREIGN PATENT DOCUMENTS

- 2216082 10/1989 United Kingdom 296/97.5

OTHER PUBLICATIONS

S. S. White Manufacturing Company General Catalog, 1965 Edition, p. 62, The S. S. White Mouth Mirrors.

Primary Examiner—James M. Gandy

Assistant Examiner—Melody Brown

Attorney, Agent, or Firm—Henri J. A. Charmasson

[57] CLAIM

The ornamental design for a portable personal sun shade, as shown and described.

DESCRIPTION

FIG. 1 is a rear, top and right side perspective view of a portable personal sun shade showing my new design; FIG. 2 is a front, bottom and left side perspective view thereof;

FIG. 3 is a rear, top and right side perspective view of a portable personal sun shade showing a second embodiment of my new design;

FIG. 4 is a front, bottom and left side perspective view of FIG. 3;

FIG. 5 is a front, top and right side perspective view of a portable personal sun shade showing a third embodiment of my new design; and

FIG. 6 is a rear, bottom and left side perspective view of FIG. 5.

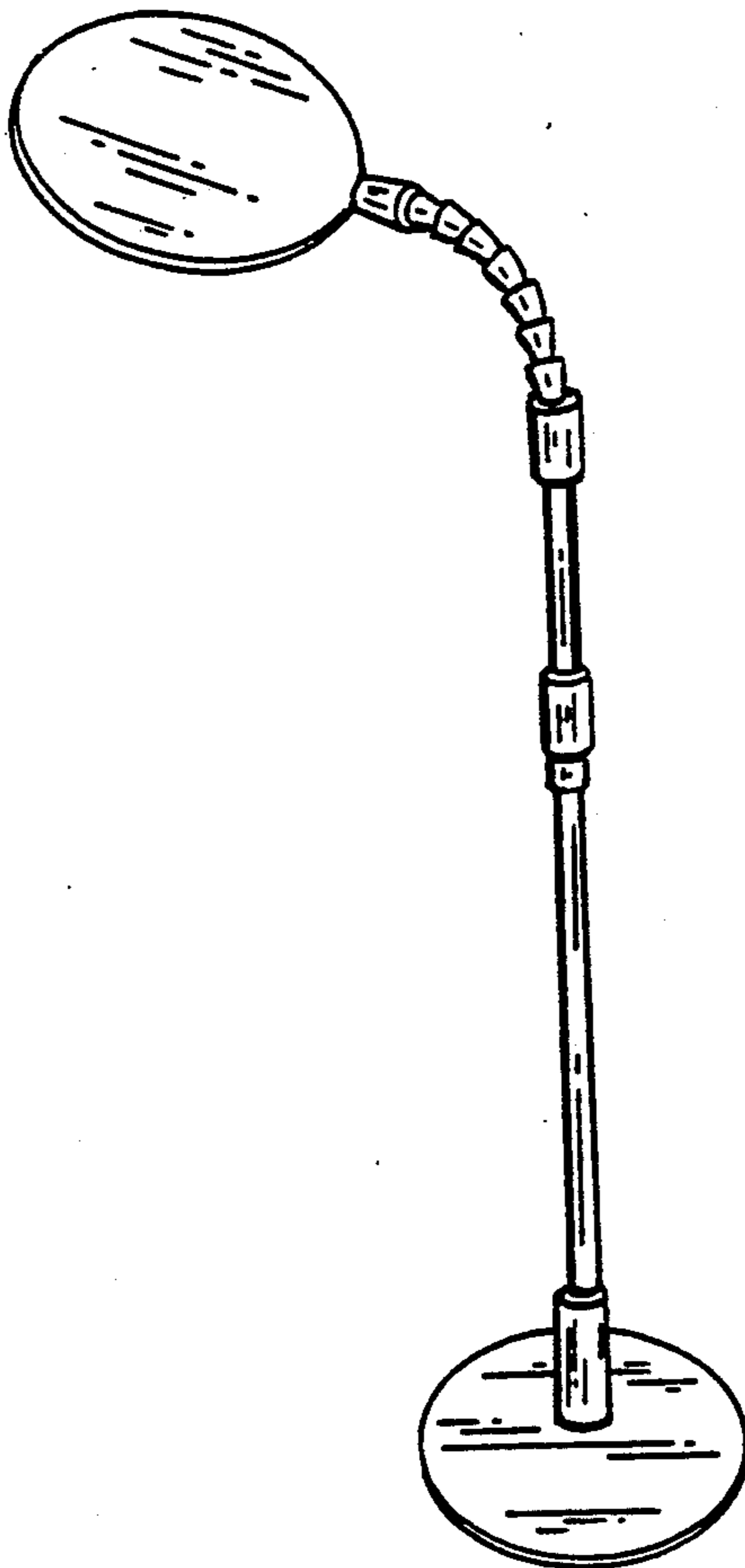

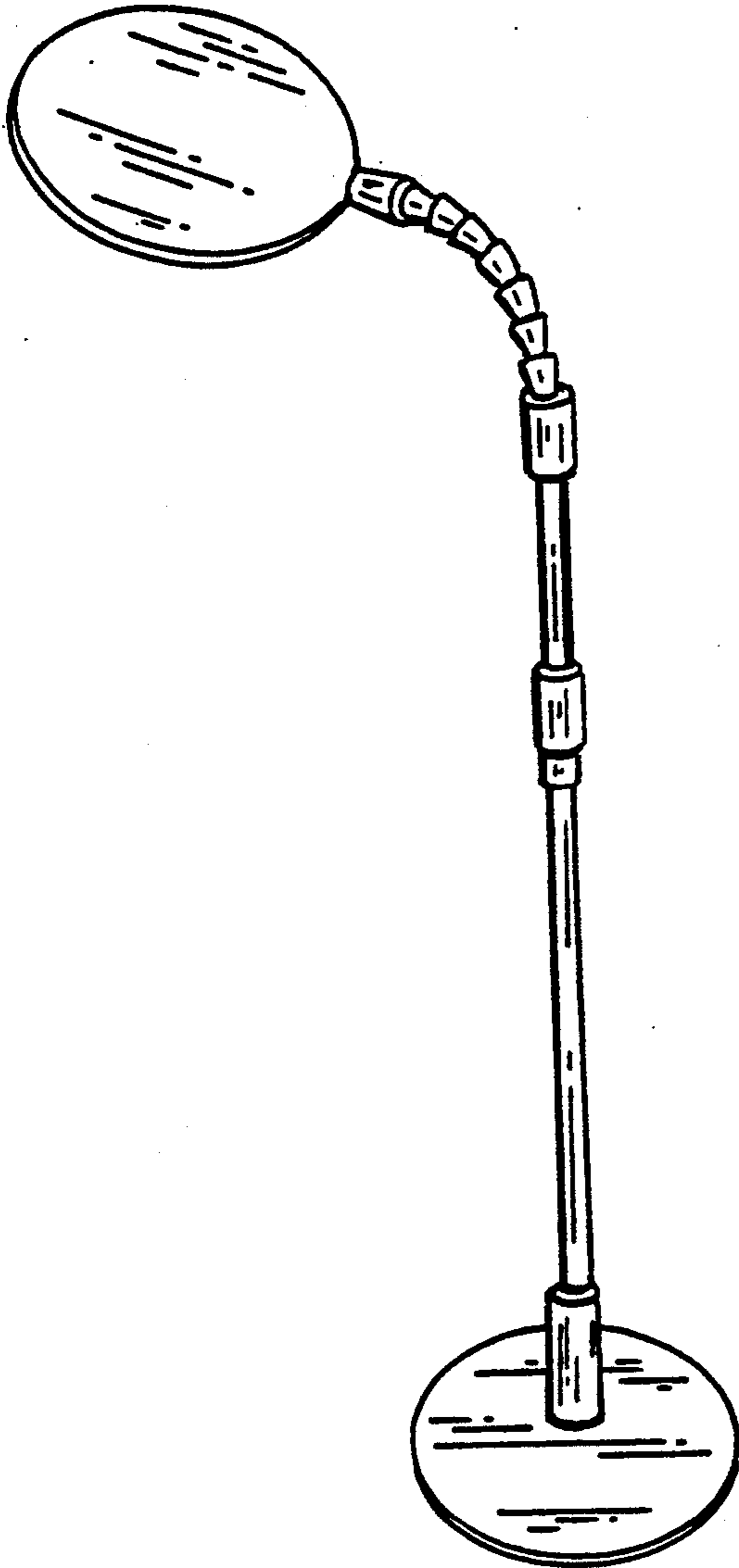

FIG. 1

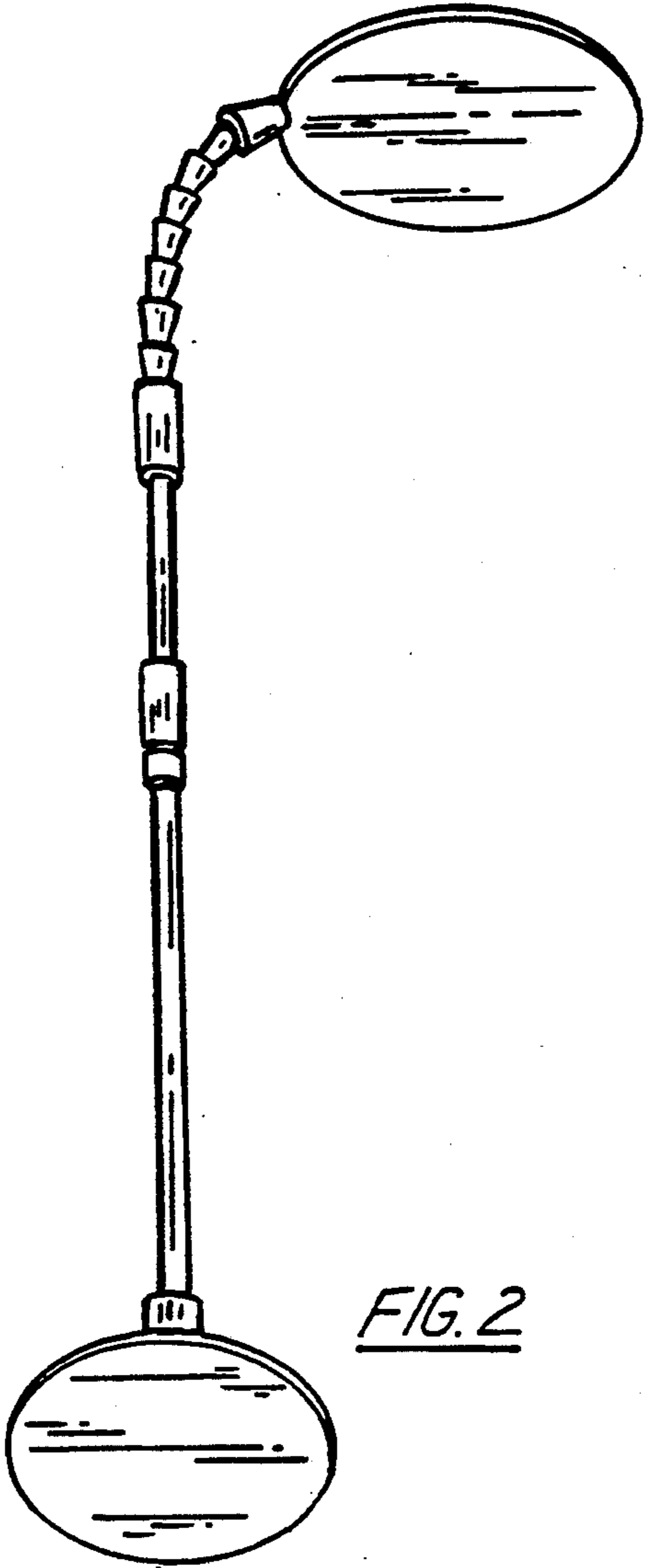
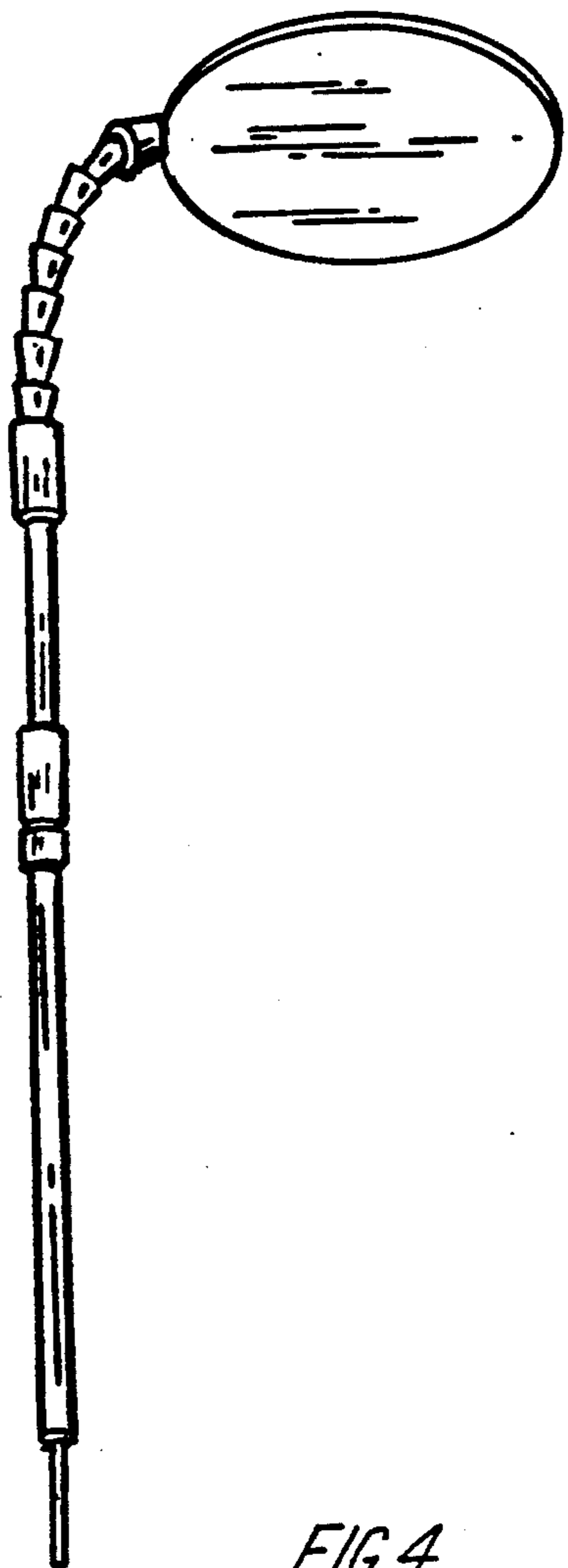
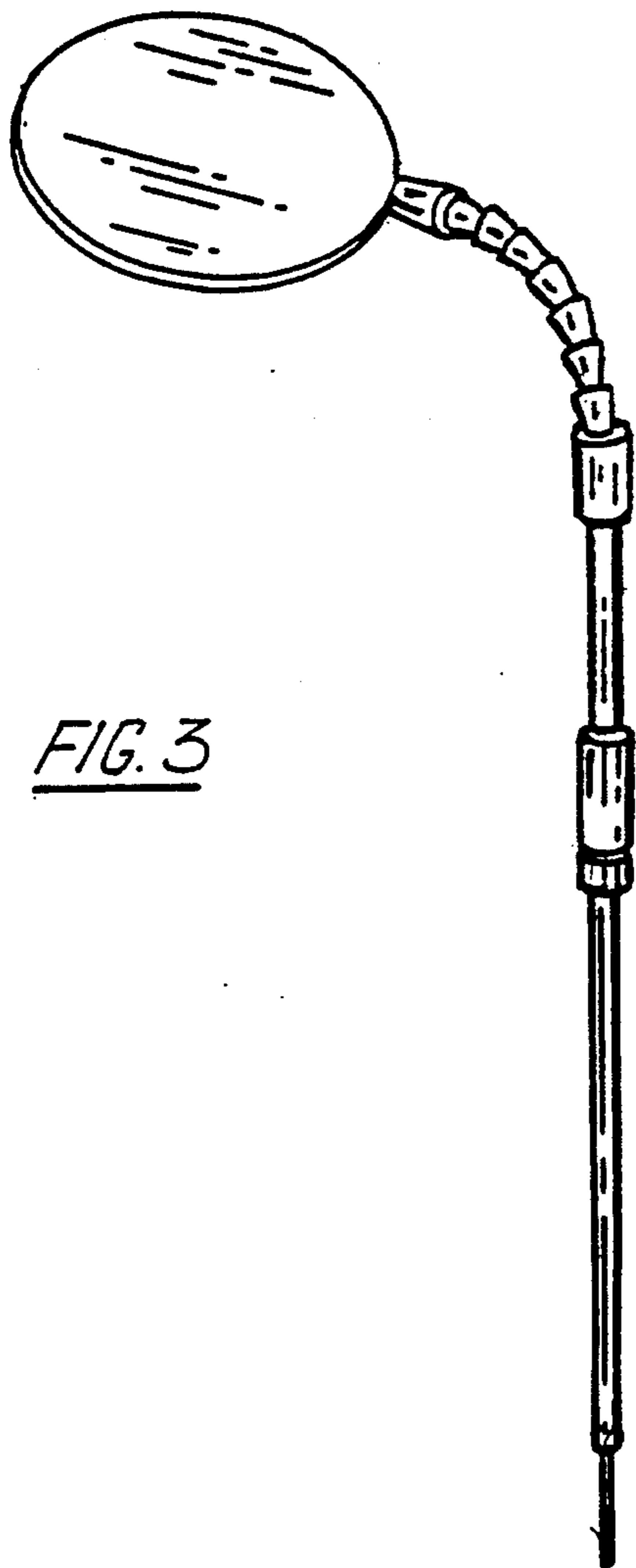

FIG. 2



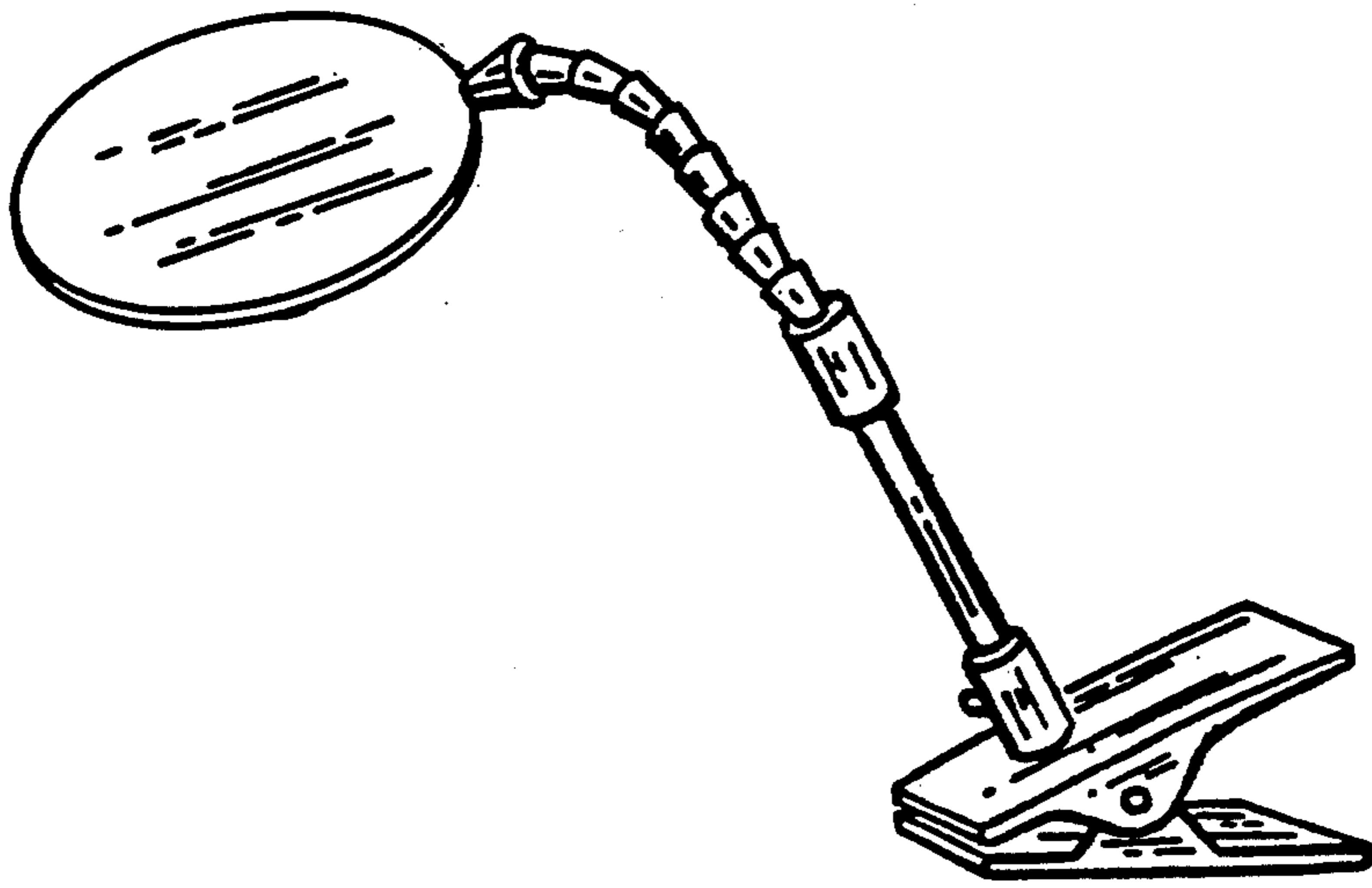

FIG. 5

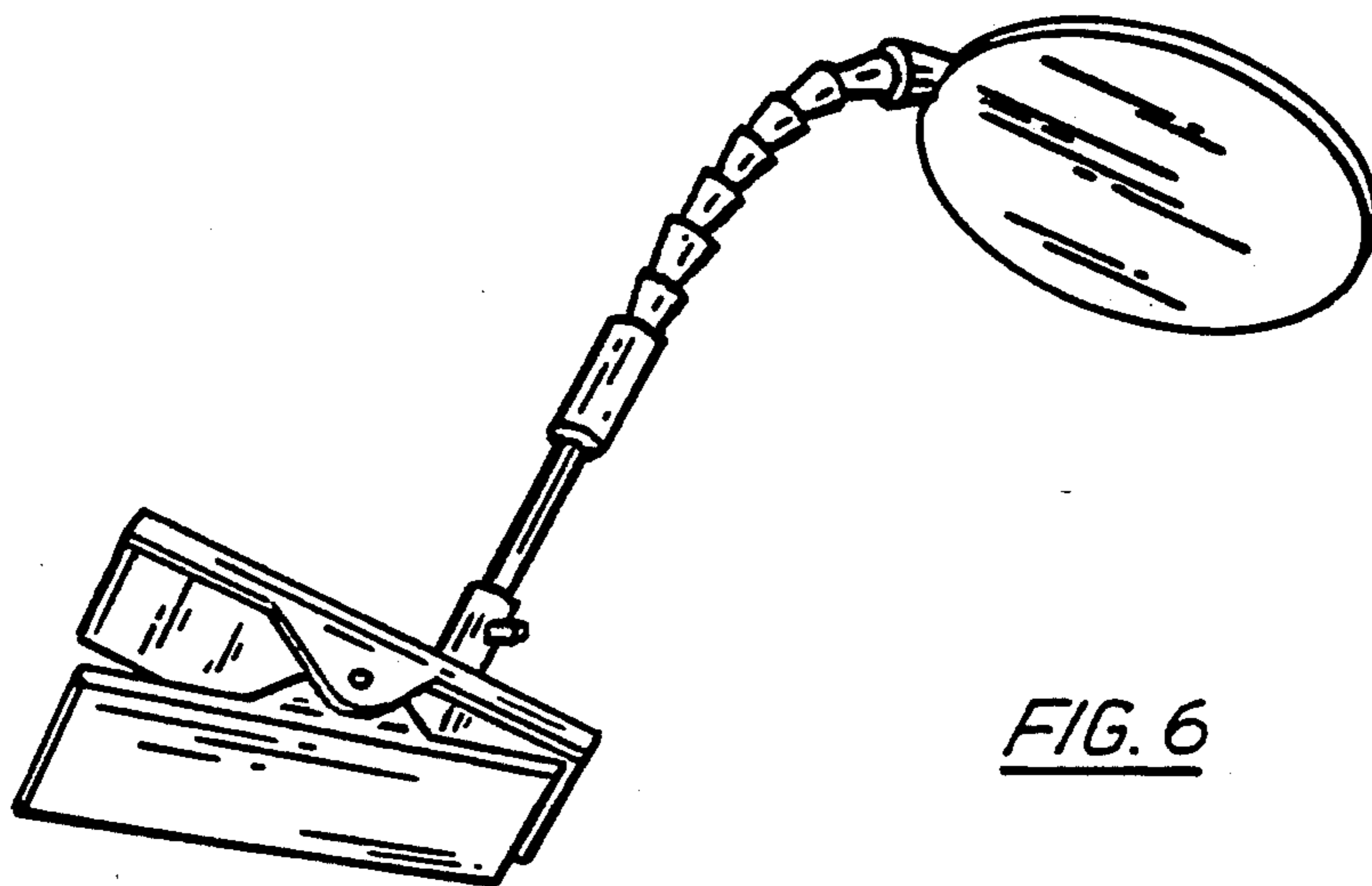

FIG. 6