



US00D323552S

United States Patent [19]

[11] Patent Number: **Des. 323,552**

Baldwin et al.

[45] Date of Patent: **** Jan. 28, 1992**

[54] COVER FOR A TRANSPORT REFRIGERATION UNIT

[56] References Cited

U.S. PATENT DOCUMENTS

[75] Inventors: **Mark W. Baldwin**, Speedway; **H. Richard Roudebush**, Greenfield, both of Ind.; **Robert A. Chopko**, Liverpool; **Robert S. Simeone**, Bridgeport, both of N.Y.

D. 242,798	12/1976	Forsty et al.	D23/325
D. 258,234	2/1981	Anderson et al.	D23/325
D. 287,619	1/1987	Allard et al.	D23/325
4,551,986	11/1985	Anderson et al.	62/239

Primary Examiner—James M. Gandy
Assistant Examiner—Lisa Lichtenstein

[73] Assignee: **Carrier Corporation**, Syracuse, N.Y.

[57] CLAIM

[**] Term: **14 Years**

The ornamental design for a cover for a transport refrigeration unit, as shown.

[21] Appl. No.: **116,131**

DESCRIPTION

[22] Filed: **Oct. 30, 1987**

FIG. 1 is a perspective view of a cover for a transport refrigeration unit showing our new design; FIG. 2 is a front elevational view thereof; FIG. 3 is a left side elevational view thereof; FIG. 4 is a right side elevational view thereof; FIG. 5 is a top plan view thereof; and FIG. 6 is a bottom plan view thereof.

[52] U.S. Cl. **D23/325**

[58] Field of Search **D23/325; 296/180.3, 296/180.4, 181; D12/97; 62/243, 239, DIG. 16, 265**

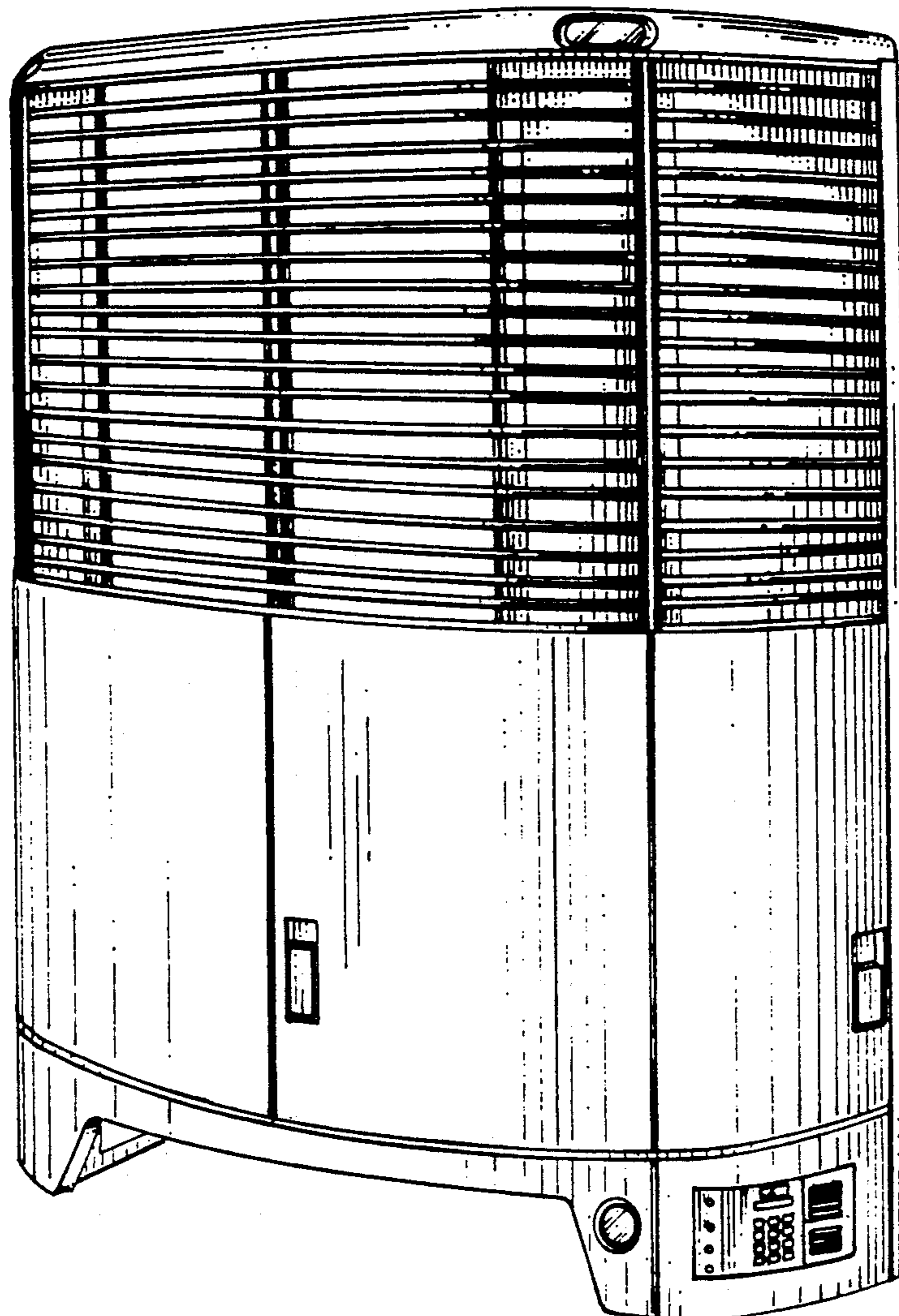

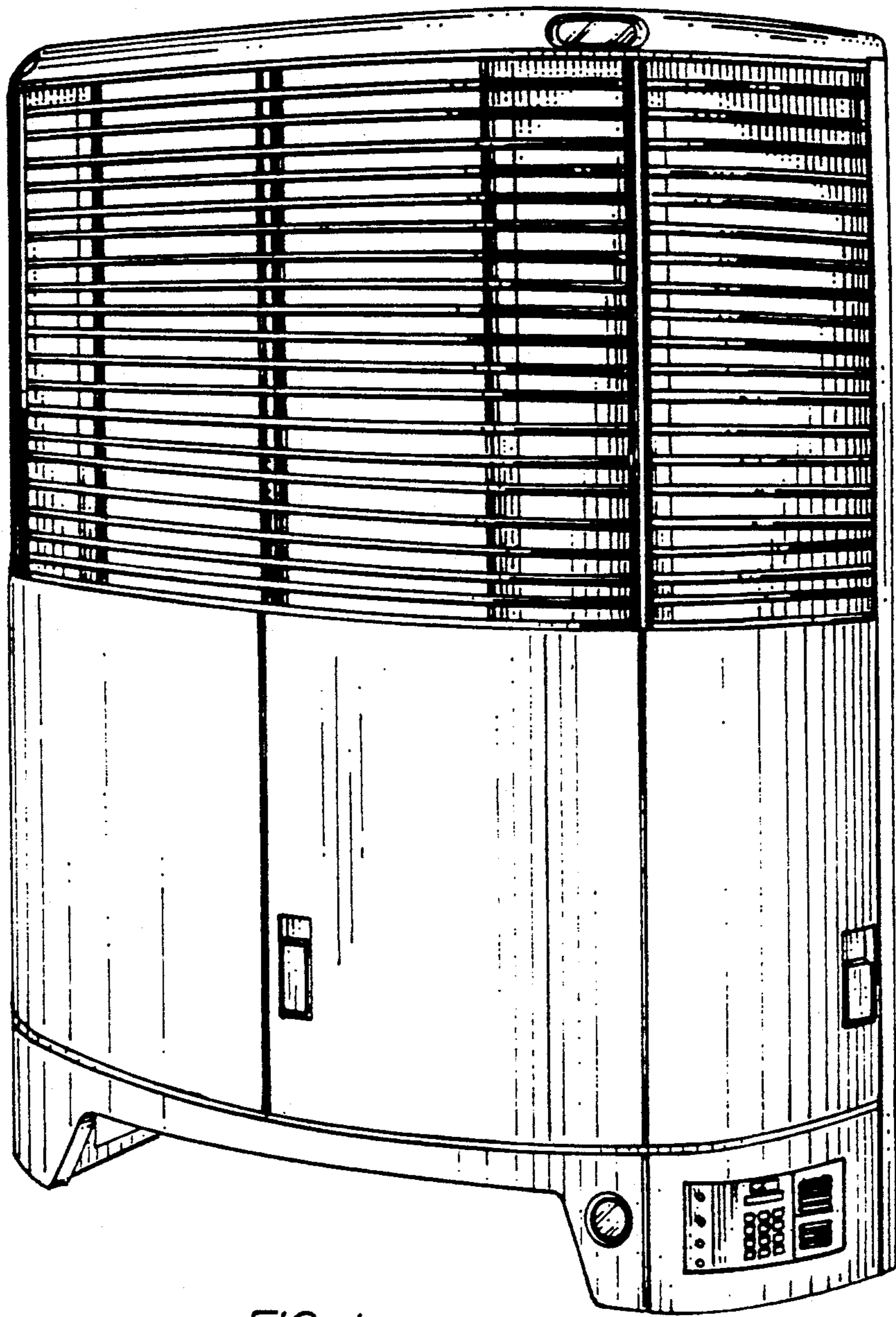

FIG. 1

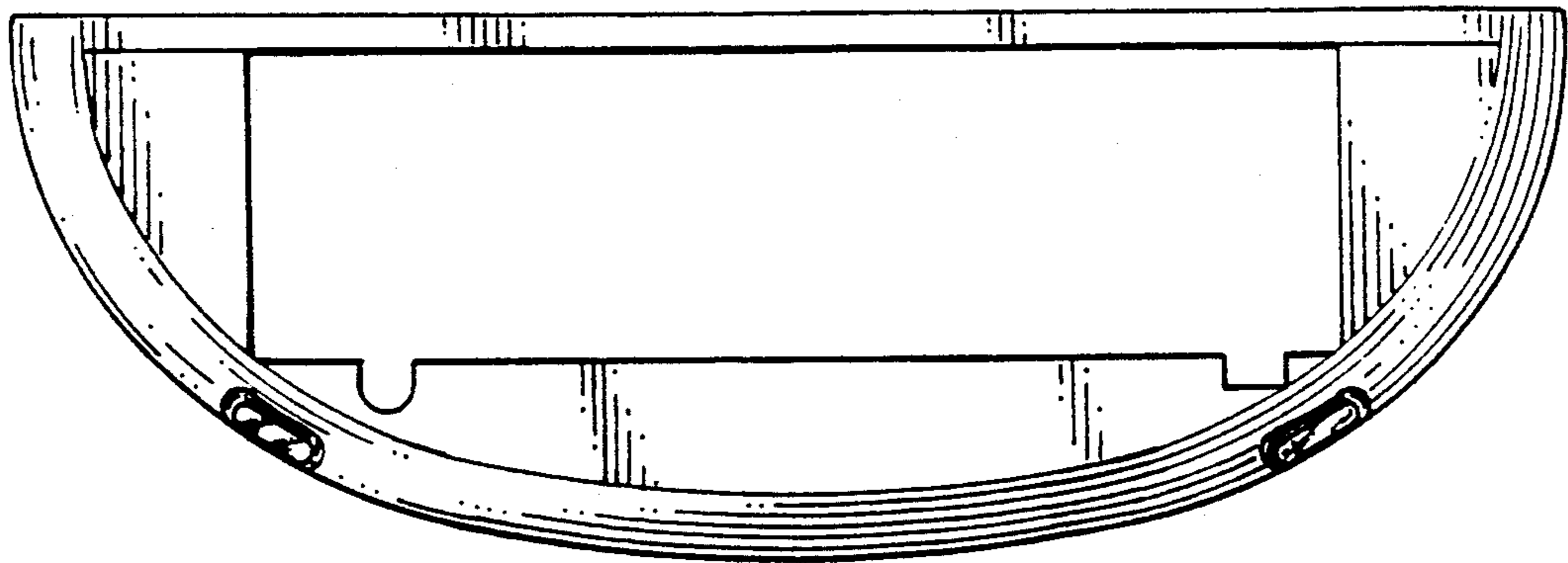

FIG. 5

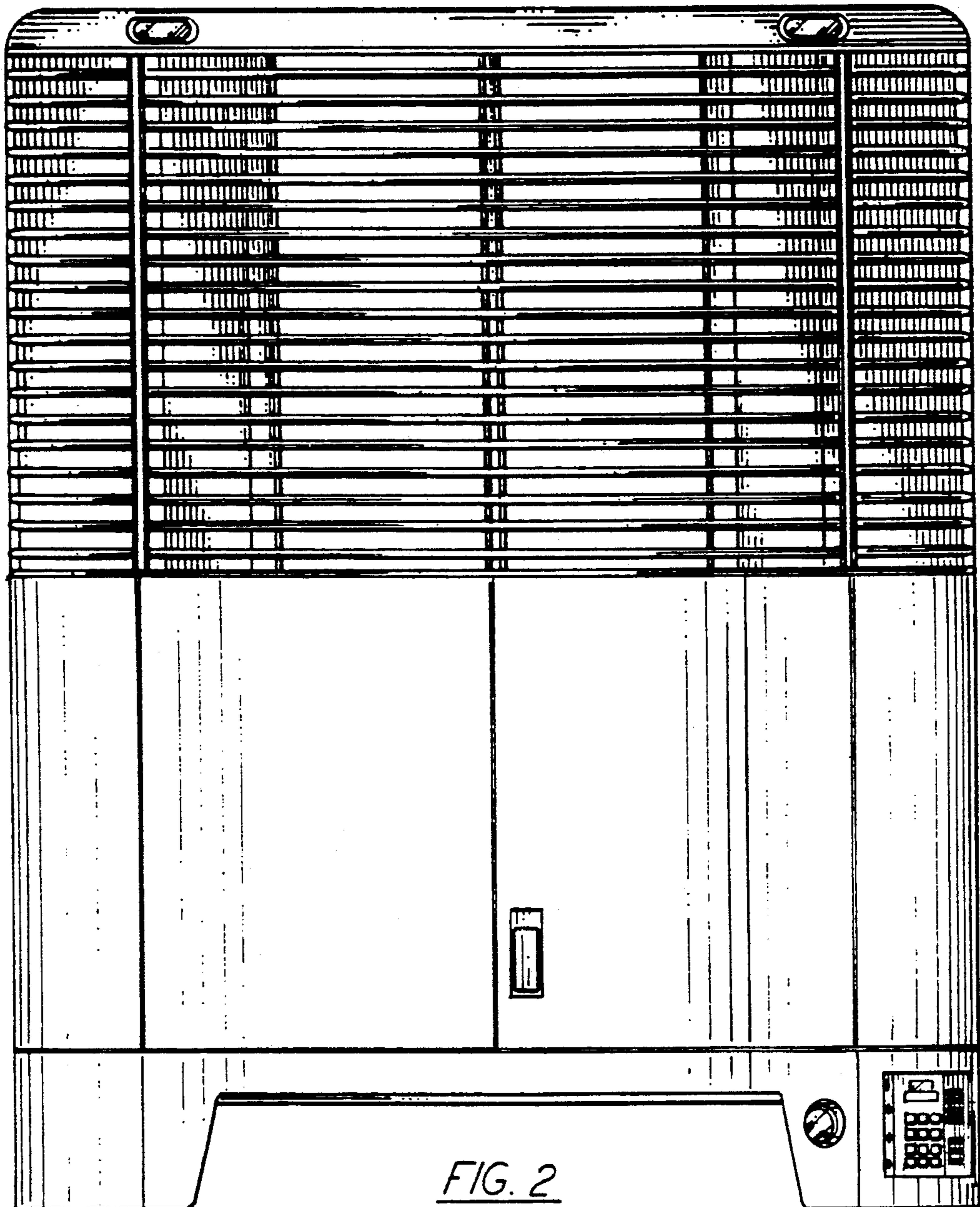

FIG. 2

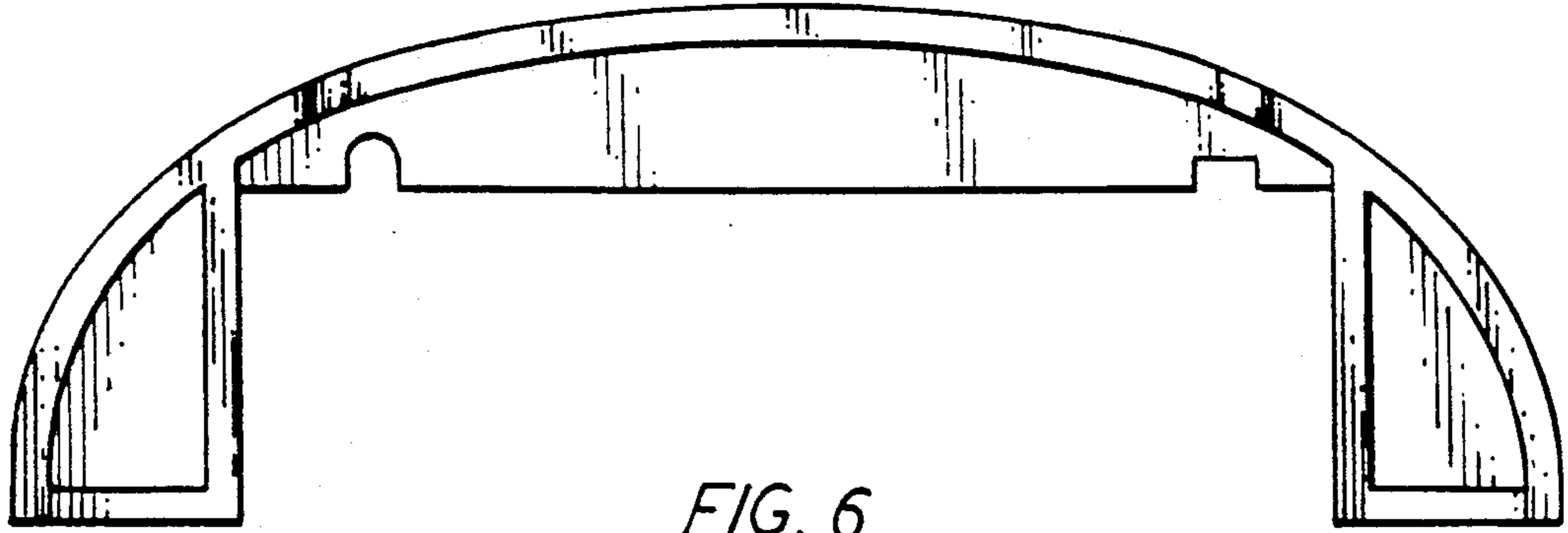

FIG. 6

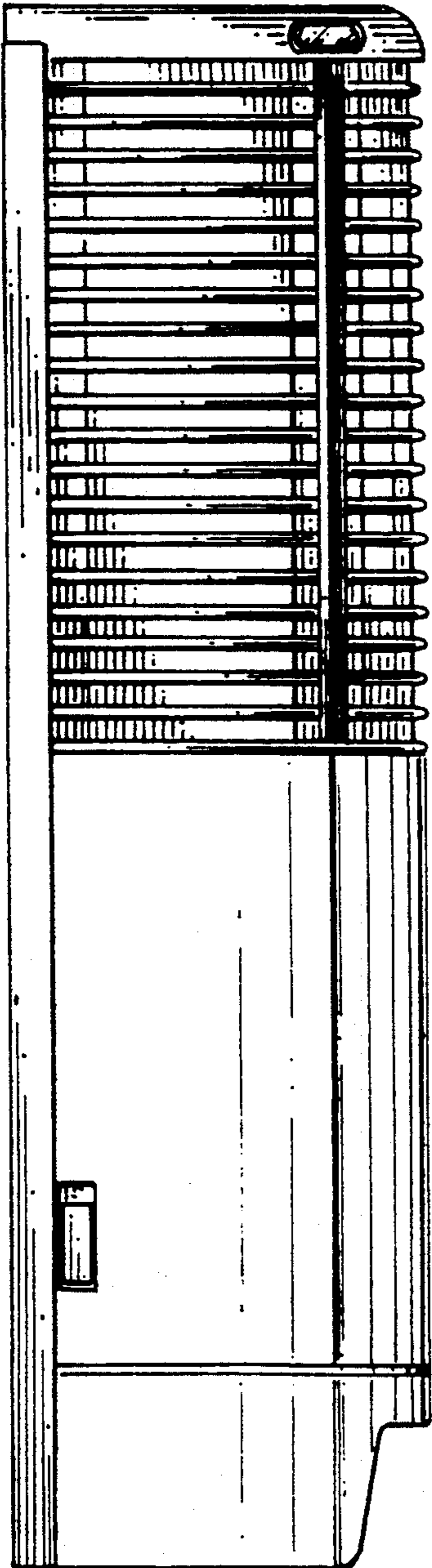

FIG. 3

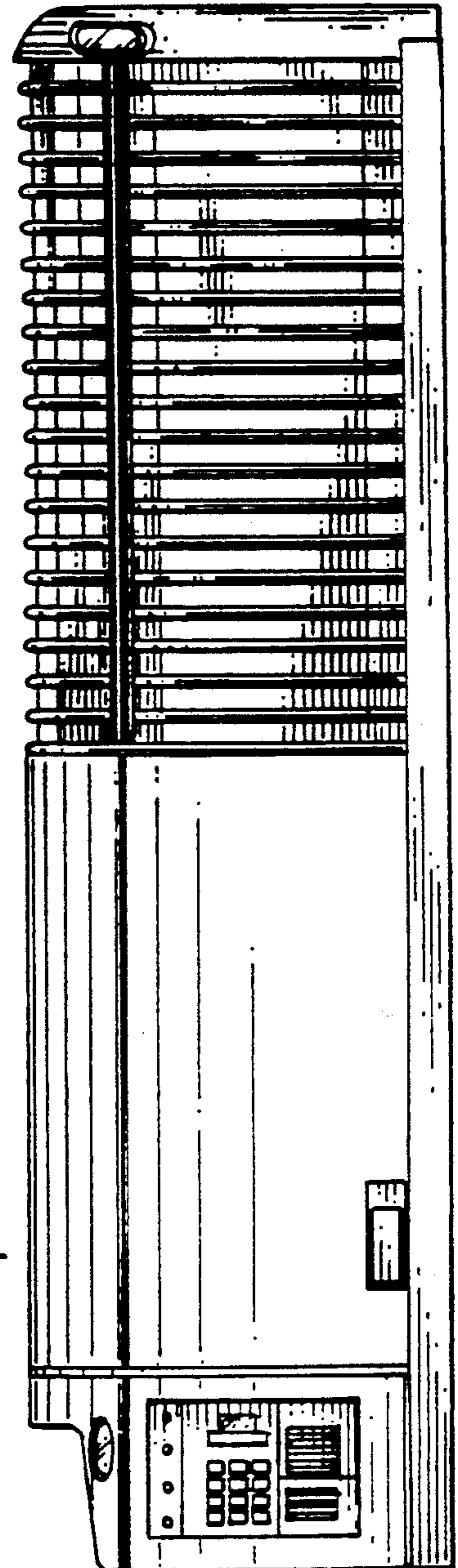

FIG. 4