



US00D323544S

United States Patent [19]

[11] Patent Number: **Des. 323,544**

Davis

[45] Date of Patent: **** Jan. 28, 1992**

[54] WATERING CAN

D. 278,928	5/1985	Gerber	D23/212
D. 314,810	2/1991	Carlson	D23/212
4,700,892	10/1987	Cunning	239/378 X

[75] Inventor: **Norman Davis, Melville, N.Y.**

[73] Assignee: **Majestic Moulded Products, Inc., Holbrook, N.Y.**

[**] Term: **14 Years**

Primary Examiner—Susan J. Lucas
Assistant Examiner—M. H. Tung
Attorney, Agent, or Firm—Finnegan, Henderson, Farabow, Garrett & Dunner

[21] Appl. No.: **544,166**

[57] **CLAIM**

[22] Filed: **Jun. 26, 1990**

The ornamental design for a watering can, as shown and described.

[52] U.S. Cl. **D23/212**

[58] Field of Search **D23/211-212;**
D7/300-302, 514-516, 519; 220/855 P;
222/372, 383, 384-385, 465.1, 468, 478, 481,
565, 567, 571, 572-573; 215/1 R, 1 C;
239/375-379, 289, 333, 443, 446

DESCRIPTION

FIG. 1 is a top perspective view of a watering can showing my new design;
FIG. 2 is a left side elevational view thereof;
FIG. 3 is a right side elevational view thereof;
FIG. 4 is a front elevational view thereof;
FIG. 5 is a rear elevational view thereof;
FIG. 6 is a top plan view thereof; and
FIG. 7 is a bottom plan view thereof.

[56] **References Cited**

U.S. PATENT DOCUMENTS

D. 241,248 8/1976 Burke **D23/212**

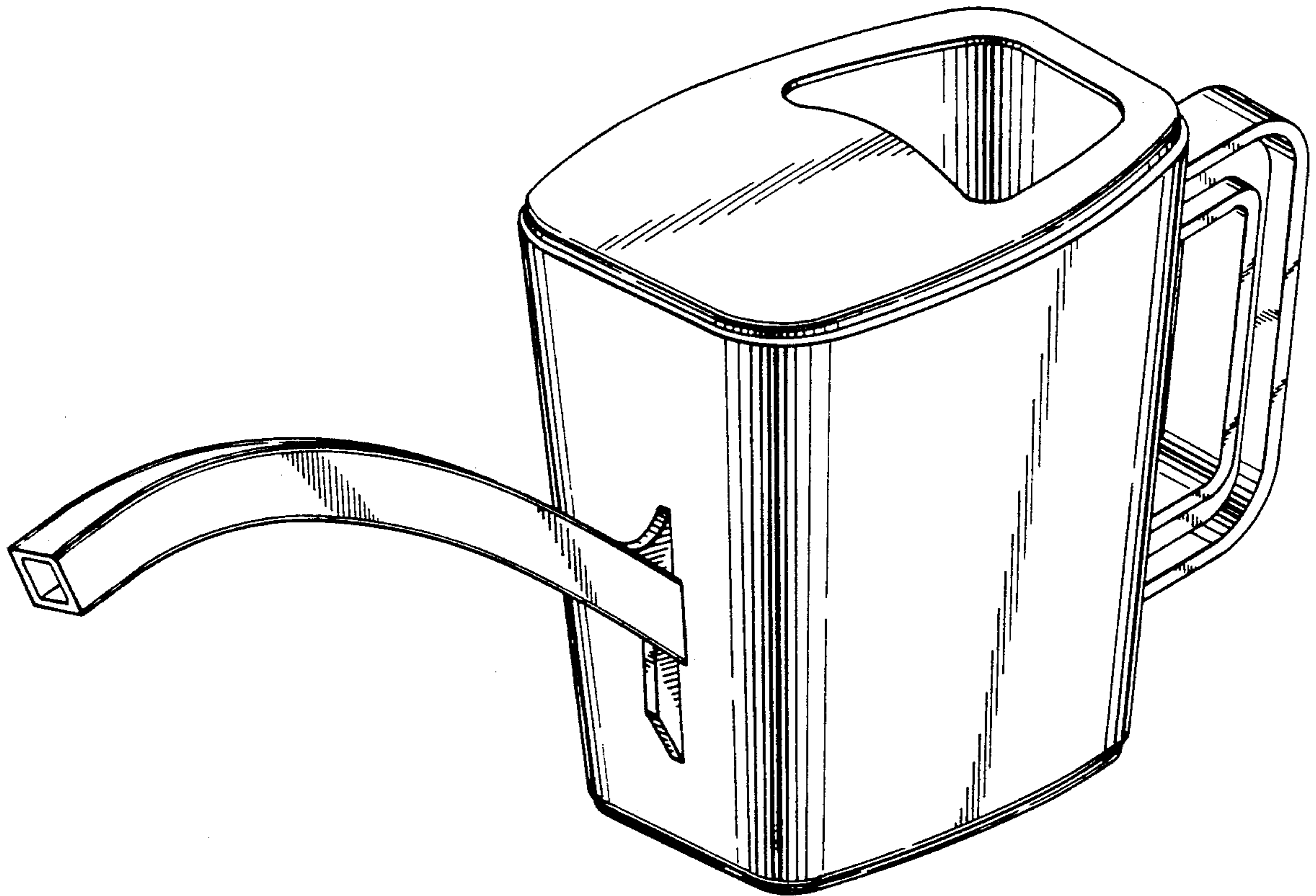

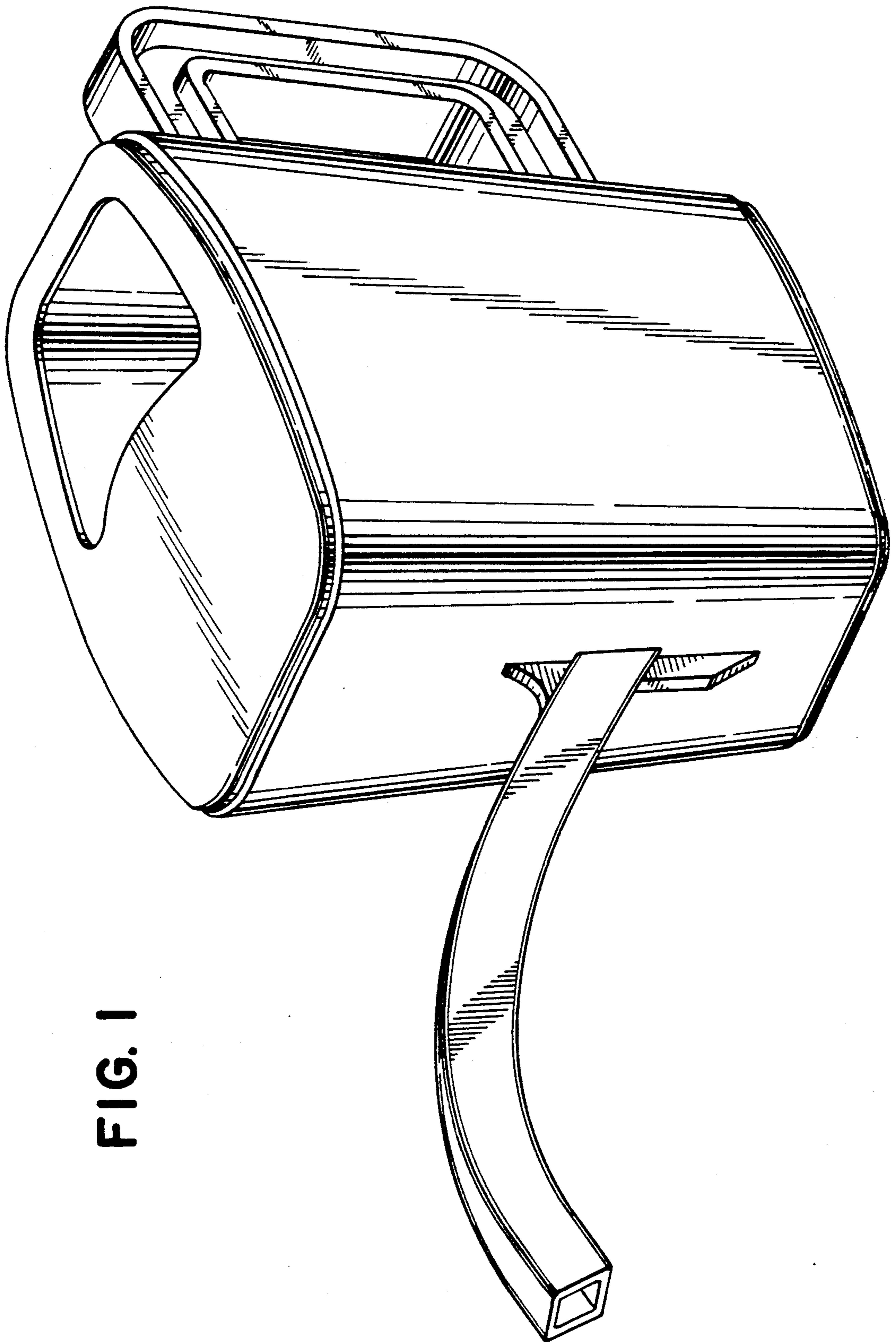

FIG. 1

FIG. 2

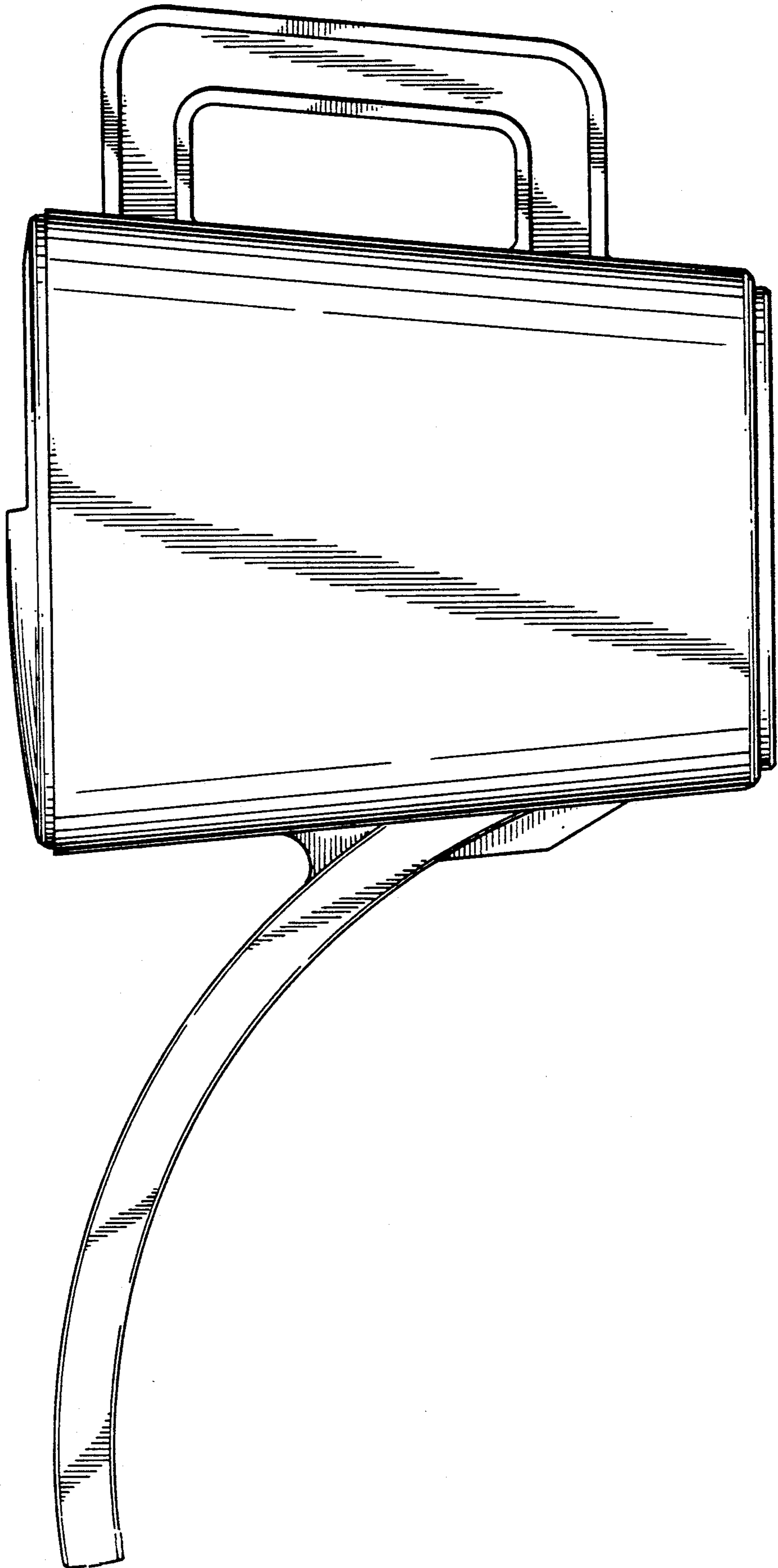

FIG. 3

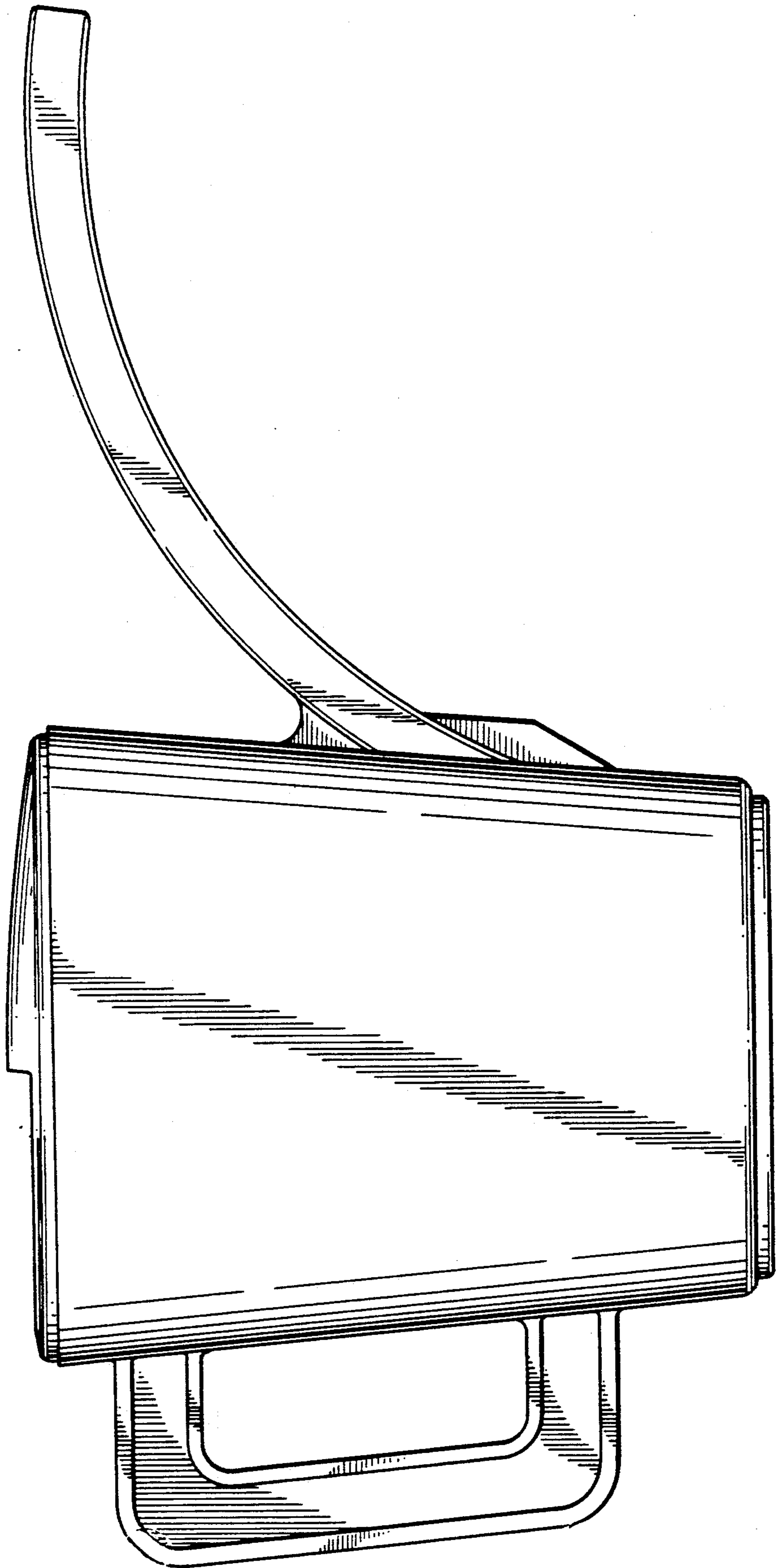

FIG. 5

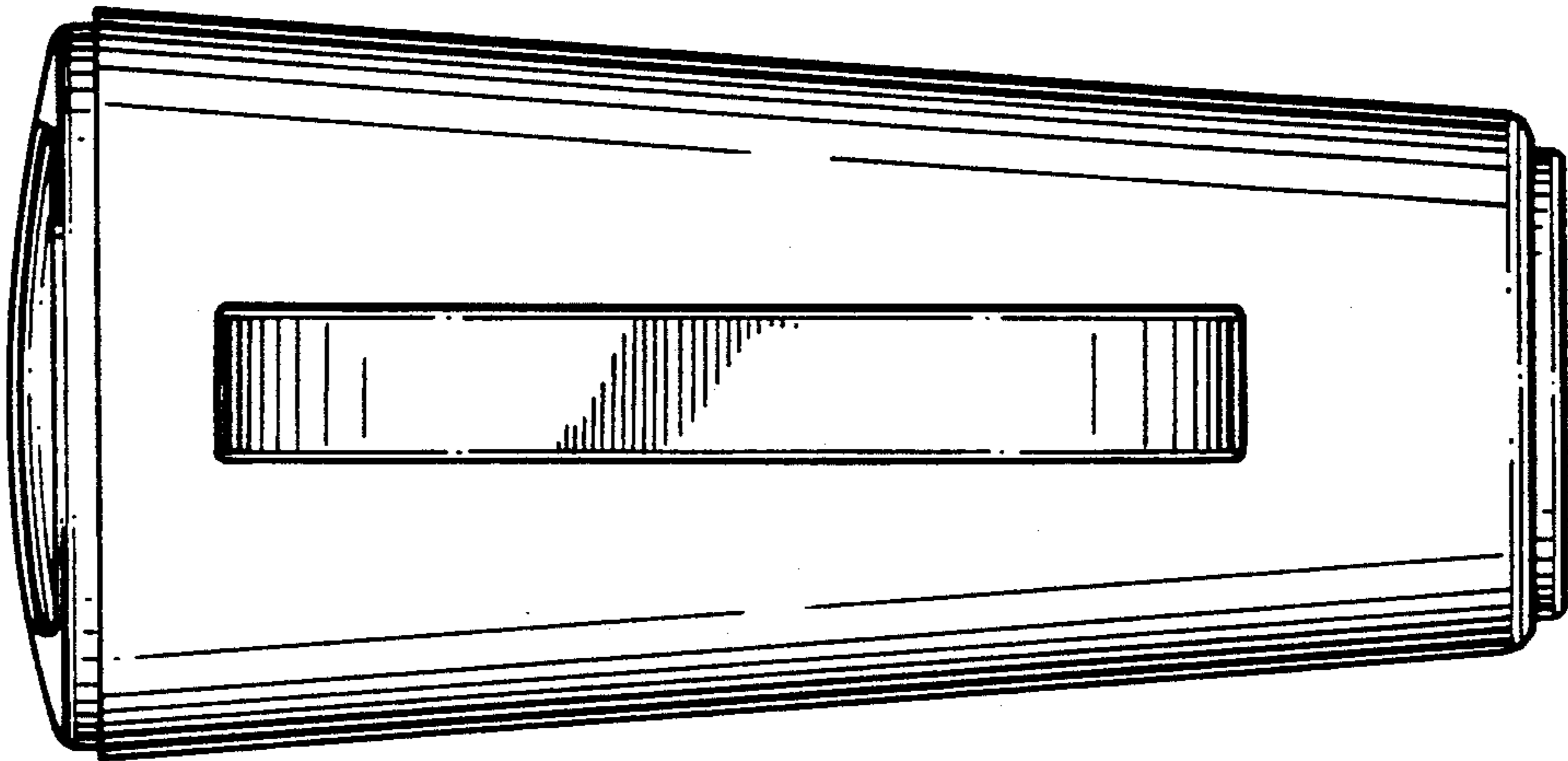
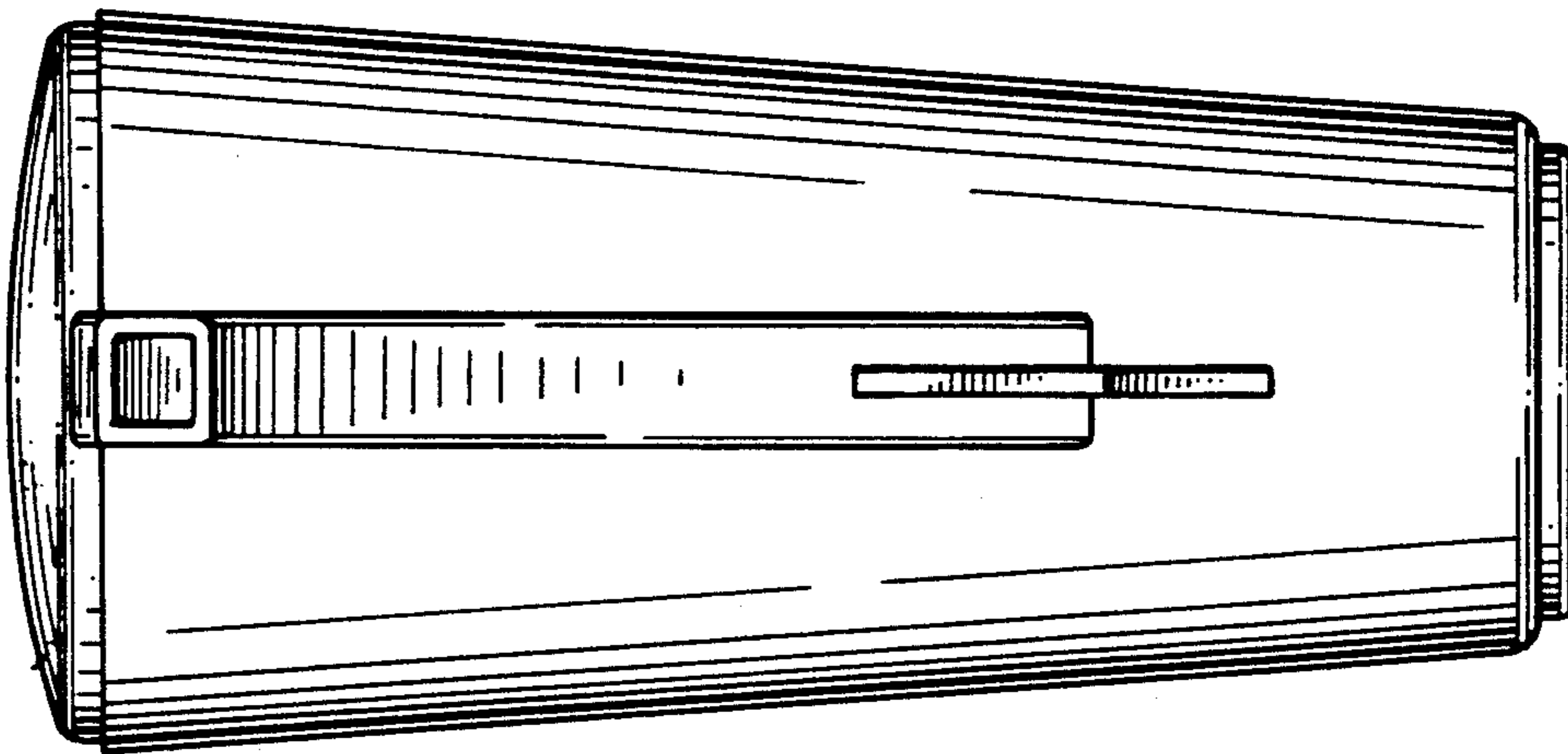

FIG. 4



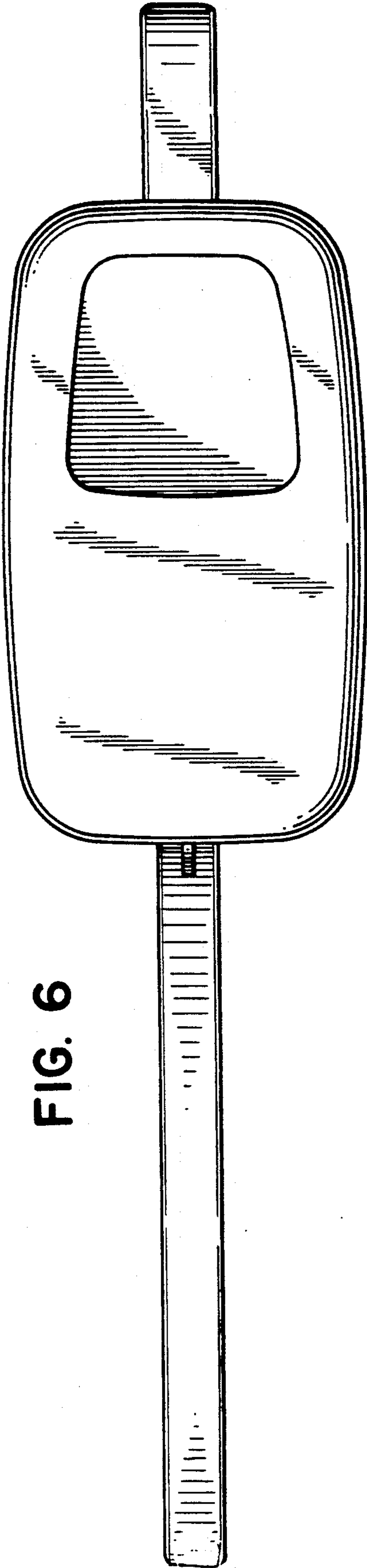

FIG. 6

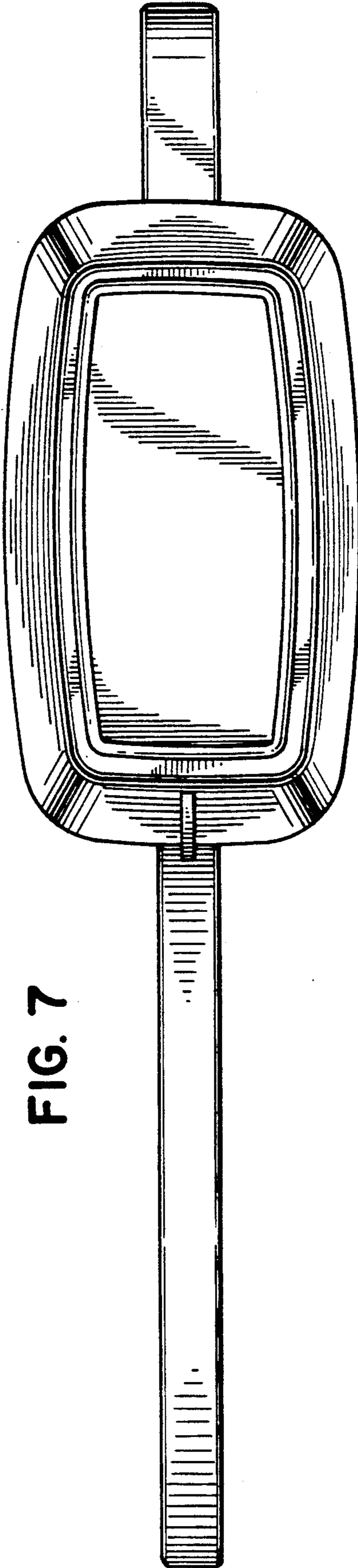

FIG. 7