



US00D323531S

United States Patent [19] Fortune

[11] Patent Number: **Des. 323,531**

[45] Date of Patent: **** Jan. 28, 1992**

[54] **STRAND MATERIAL DISPENSER OR THE LIKE**

4,718,633 1/1988 Weixel 242/129
4,763,854 8/1988 Borowski 242/129

[76] Inventor: **William S. Fortune**, 29866 Cuthbert Rd., Malibu, Calif. 90265

[**] Term: **14 Years**

[21] Appl. No.: **252,870**

[22] Filed: **Oct. 3, 1988**

[52] U.S. Cl. **D19/69; D19/67**

[58] Field of Search **D19/67, 68, 69, 65, D19/99, 100; D6/518; 225/6, 39, 45, 56, 65, 89; 206/389; D9/419; 242/129, 55.3**

[56] **References Cited**

U.S. PATENT DOCUMENTS

D. 134,545	12/1942	Fischer	D19/69
D. 136,657	11/1943	Funke	D19/69 X
D. 139,665	12/1944	Kahn	D19/69
D. 186,343	10/1959	Gershen	D19/69
D. 194,756	3/1963	Norman	D19/69 X
D. 298,839	12/1988	Söderberg et al.	D19/69
D. 299,602	1/1989	Nordlander	D6/518
1,151,971	8/1915	Schulz	D19/69 X
1,166,352	12/1915	Bauer	D19/69 X
2,080,052	5/1937	Lemaster	D19/69 X
2,545,145	3/1951	Hoyle	242/129
2,678,777	5/1954	Donkin	D19/69 X
2,694,533	11/1954	Zucker	242/55.3
2,844,334	7/1958	Luth	242/129
4,715,549	12/1987	Travlos	242/129 X

OTHER PUBLICATIONS

Radio Shack 1987 catalog—See reel of solder upper center, p. 132.

Allied Electronics ©1985, see p. 367, wire dispenser, lower left.

Primary Examiner—Bruce W. Dunkins

Assistant Examiner—Martha Thompson

Attorney, Agent, or Firm—Daniel T. Anderson

[57] **CLAIM**

The ornamental design for a strand material dispenser or the like, as shown and described.

DESCRIPTION

FIG. 1 is a front elevational view of a strand material dispenser or the like, showing my new design; FIG. 2 is a left side elevational view thereof; FIG. 3 is a right side elevational view thereof; FIG. 4 is a top, plan view thereof; FIG. 5 is a bottom plan view thereof; FIG. 6 is a rear elevational view thereof; FIG. 7 is a front perspective view thereof; FIG. 8 is a rear perspective view thereof; FIG. 9 is a front perspective view thereof in an exploded condition; and FIG. 10 is a rear perspective view thereof in an exploded condition.

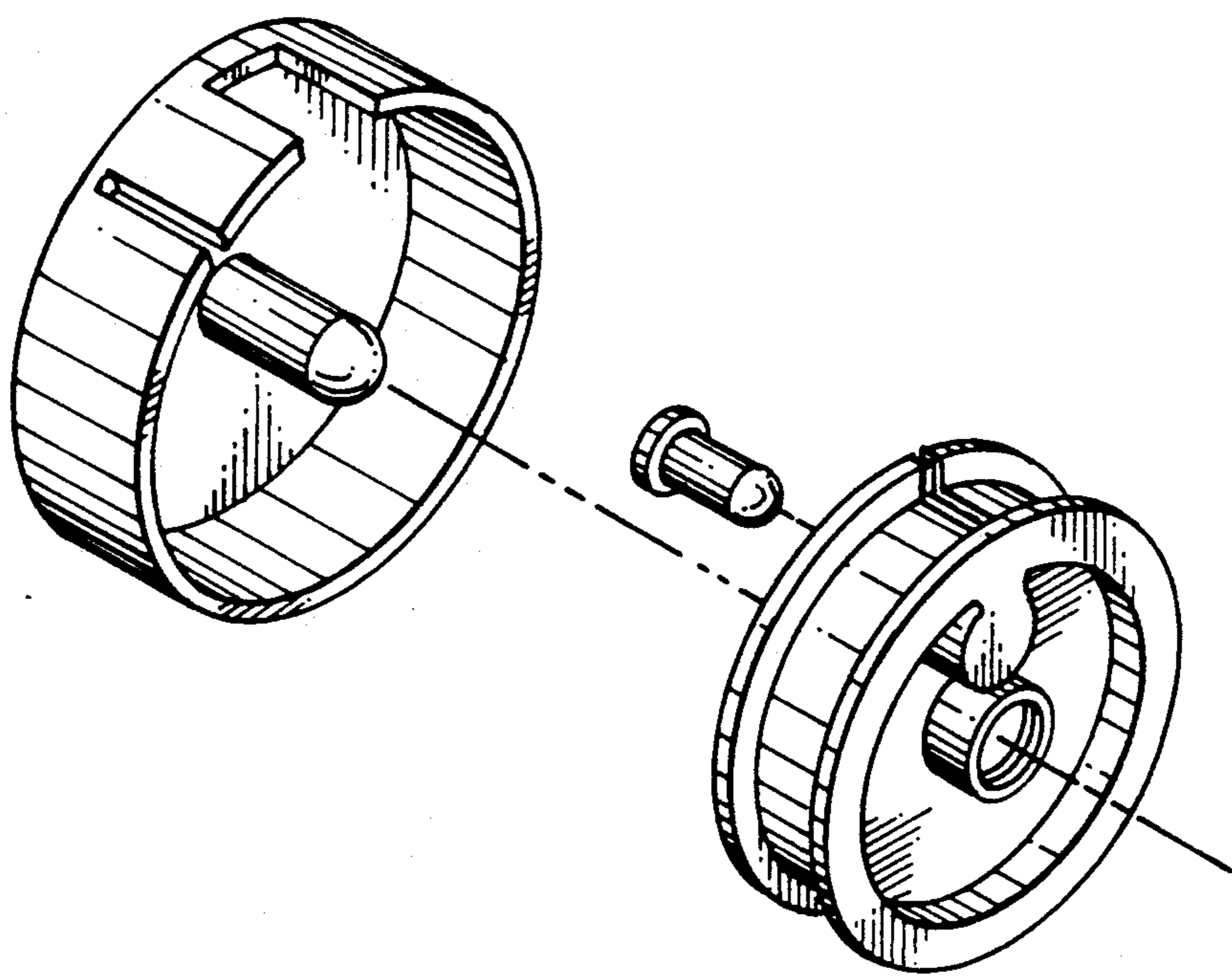

Fig. 4

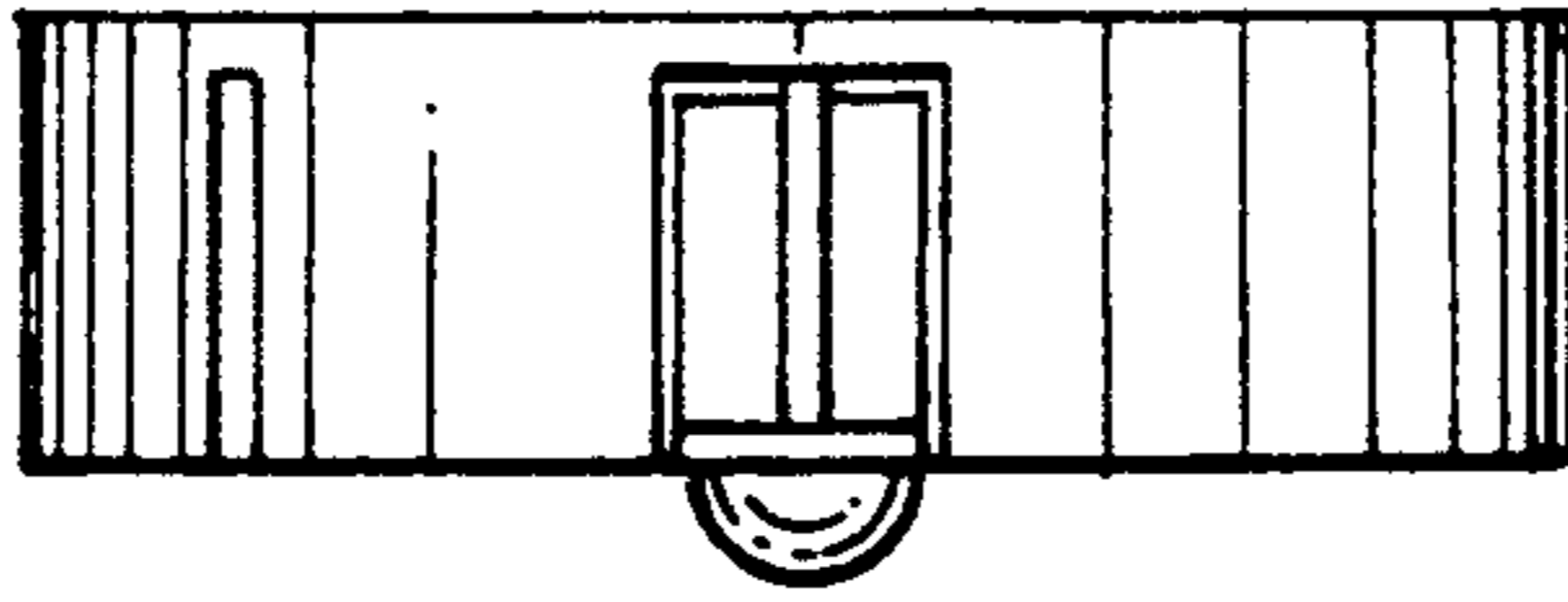

Fig. 2

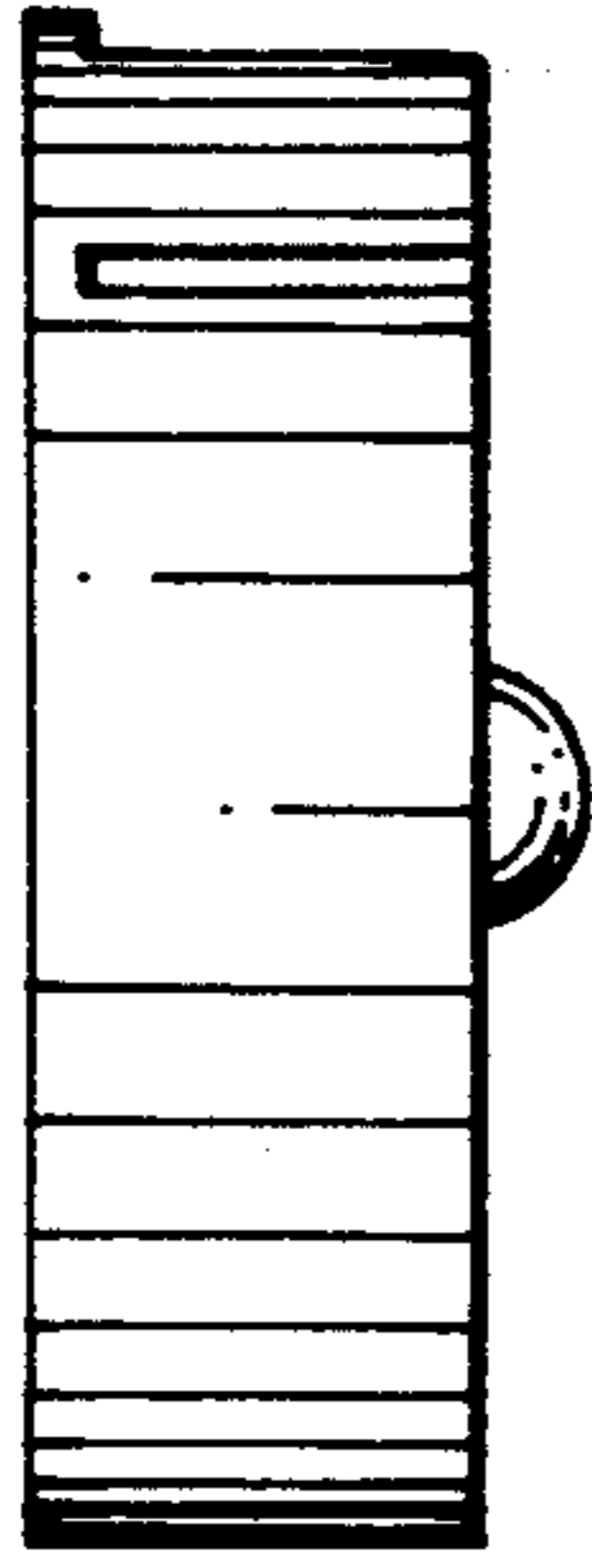

Fig. 3

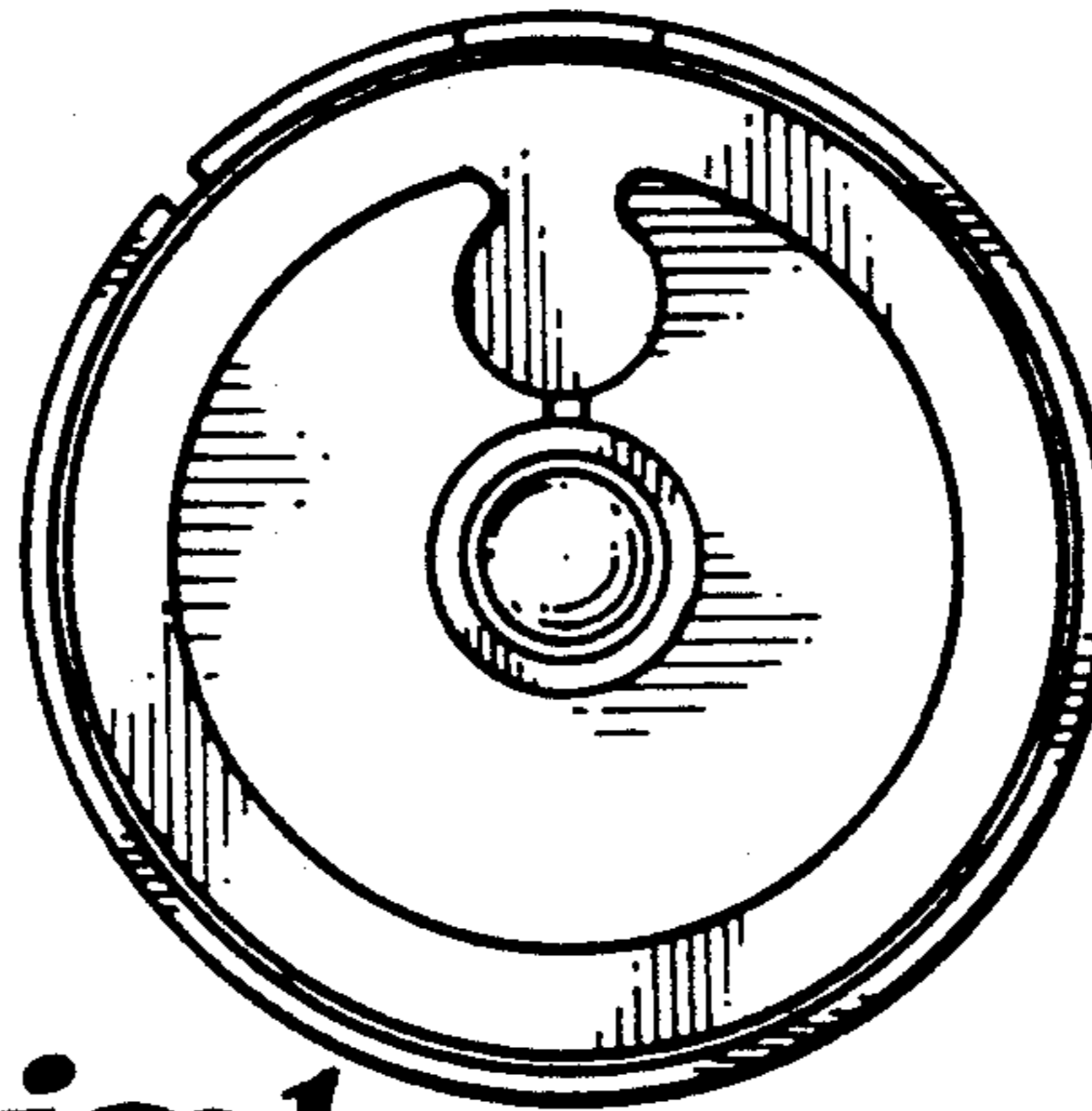
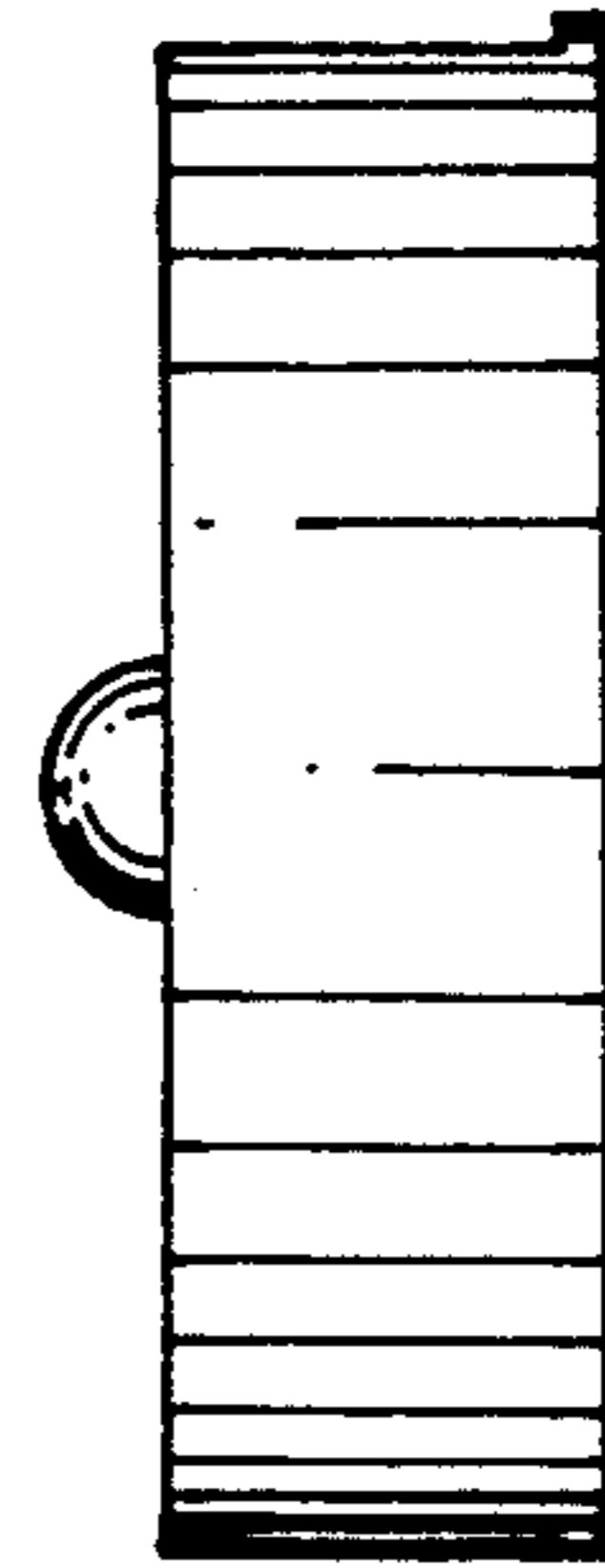

Fig. 1

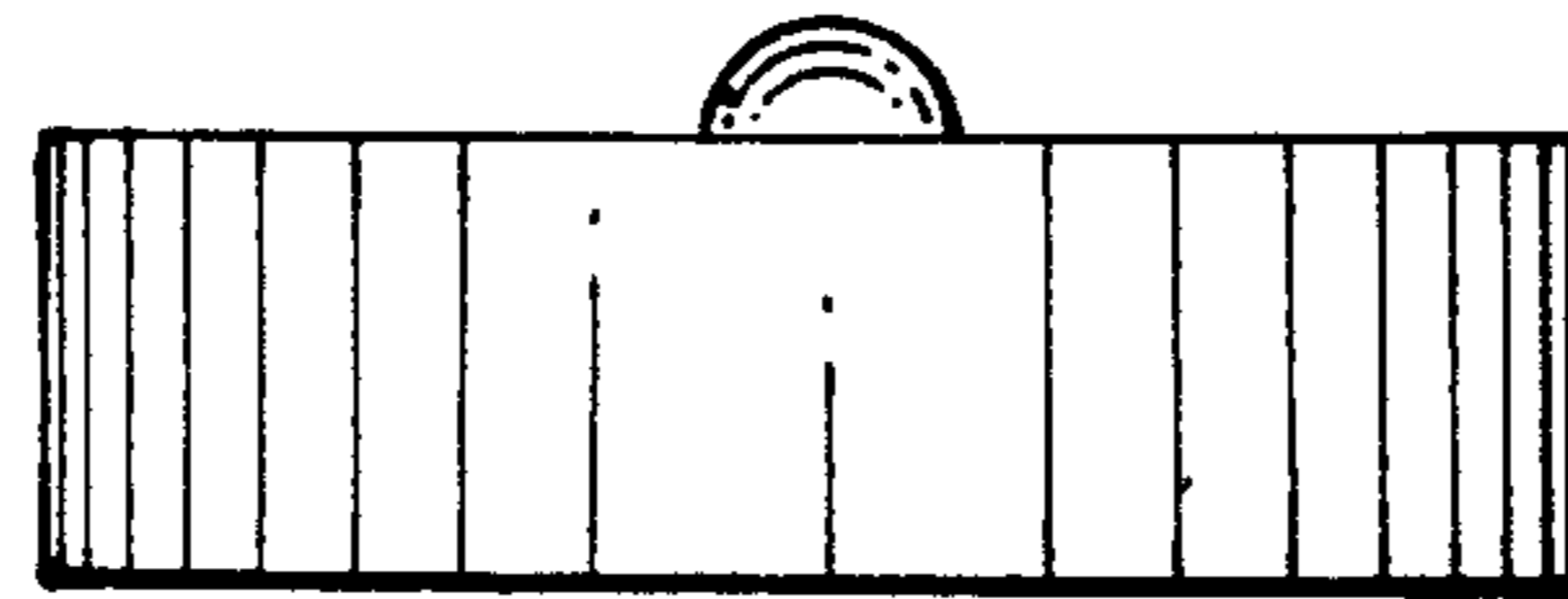

Fig. 5

Fig. 6

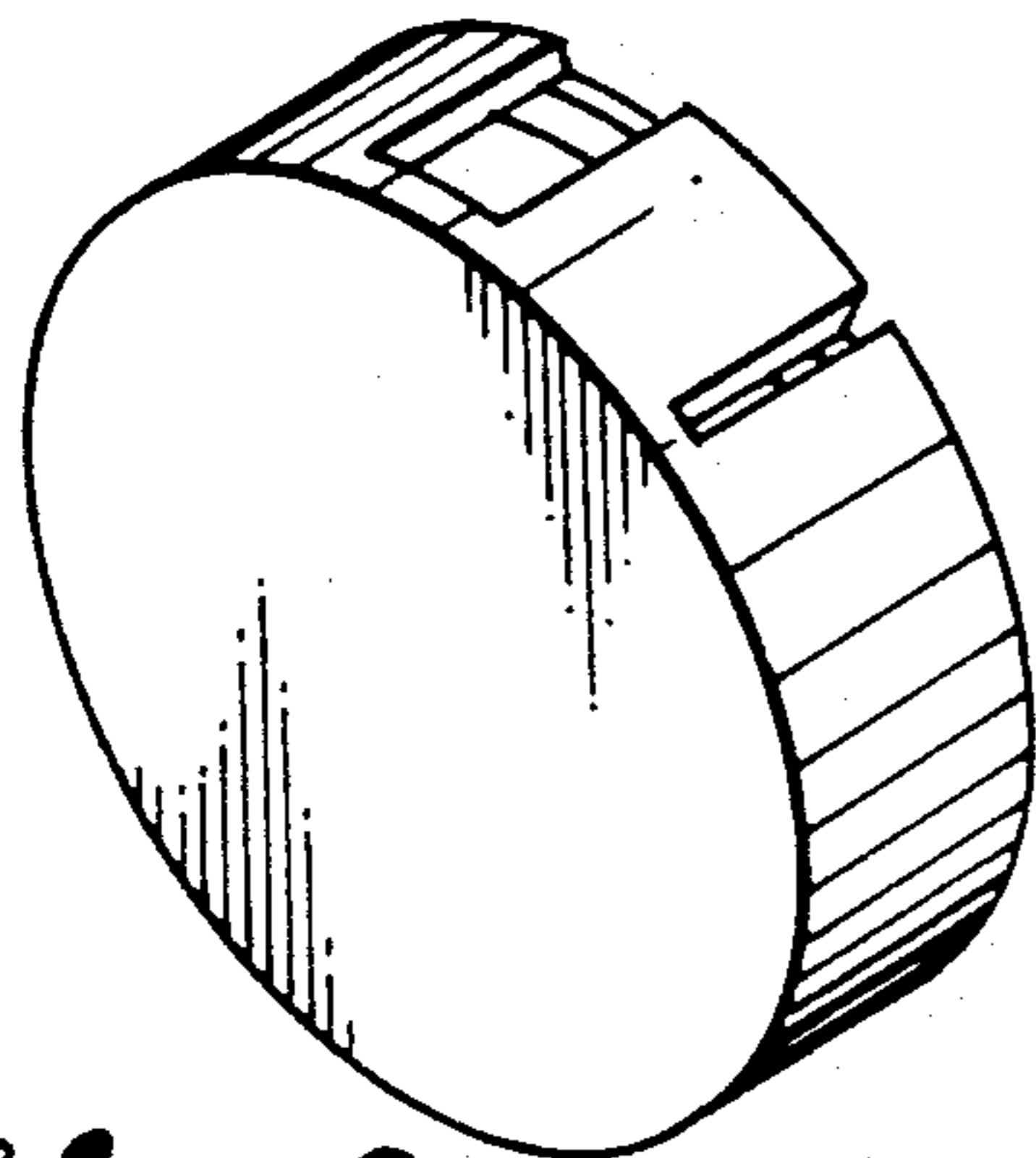
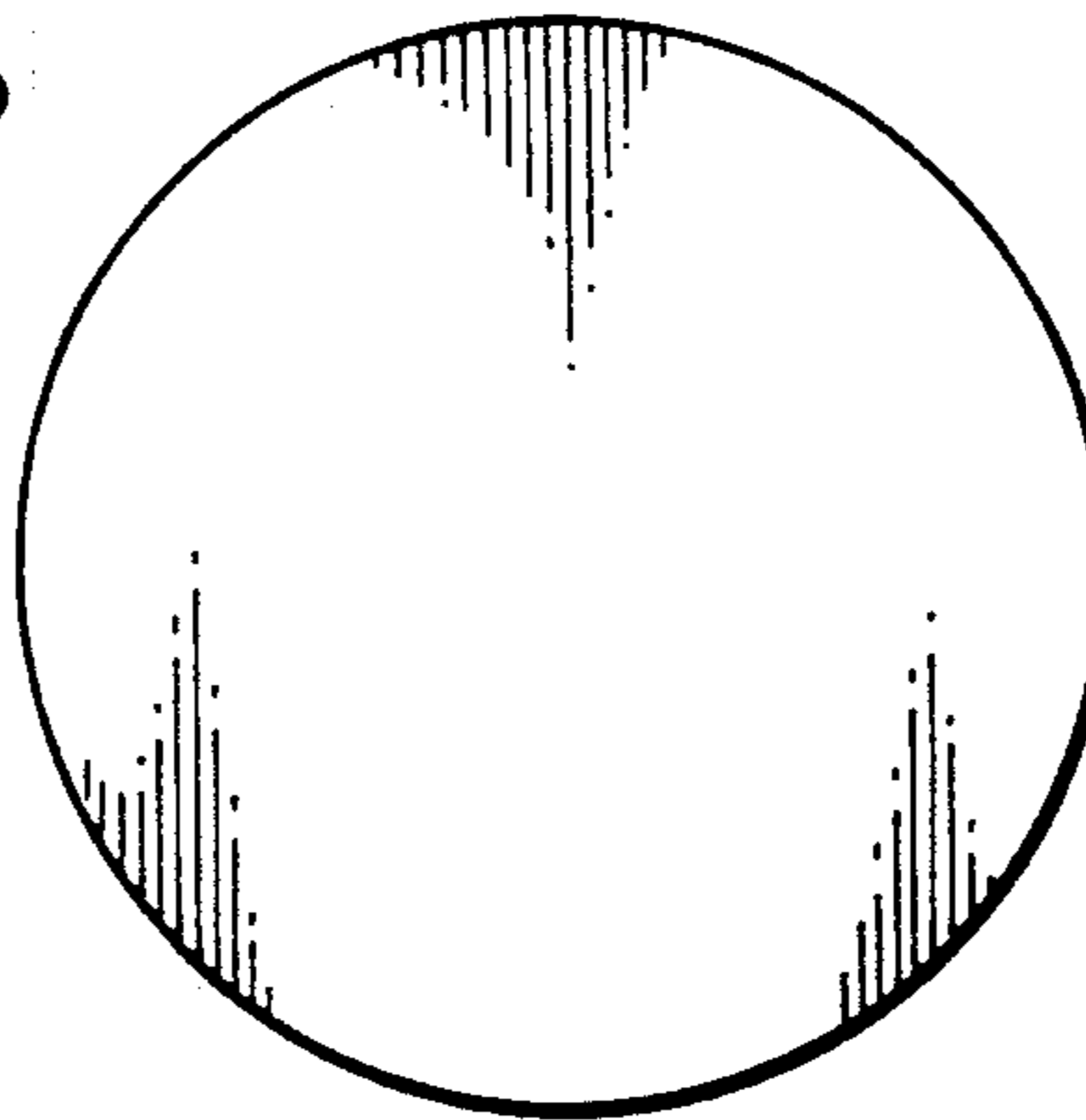

Fig. 8

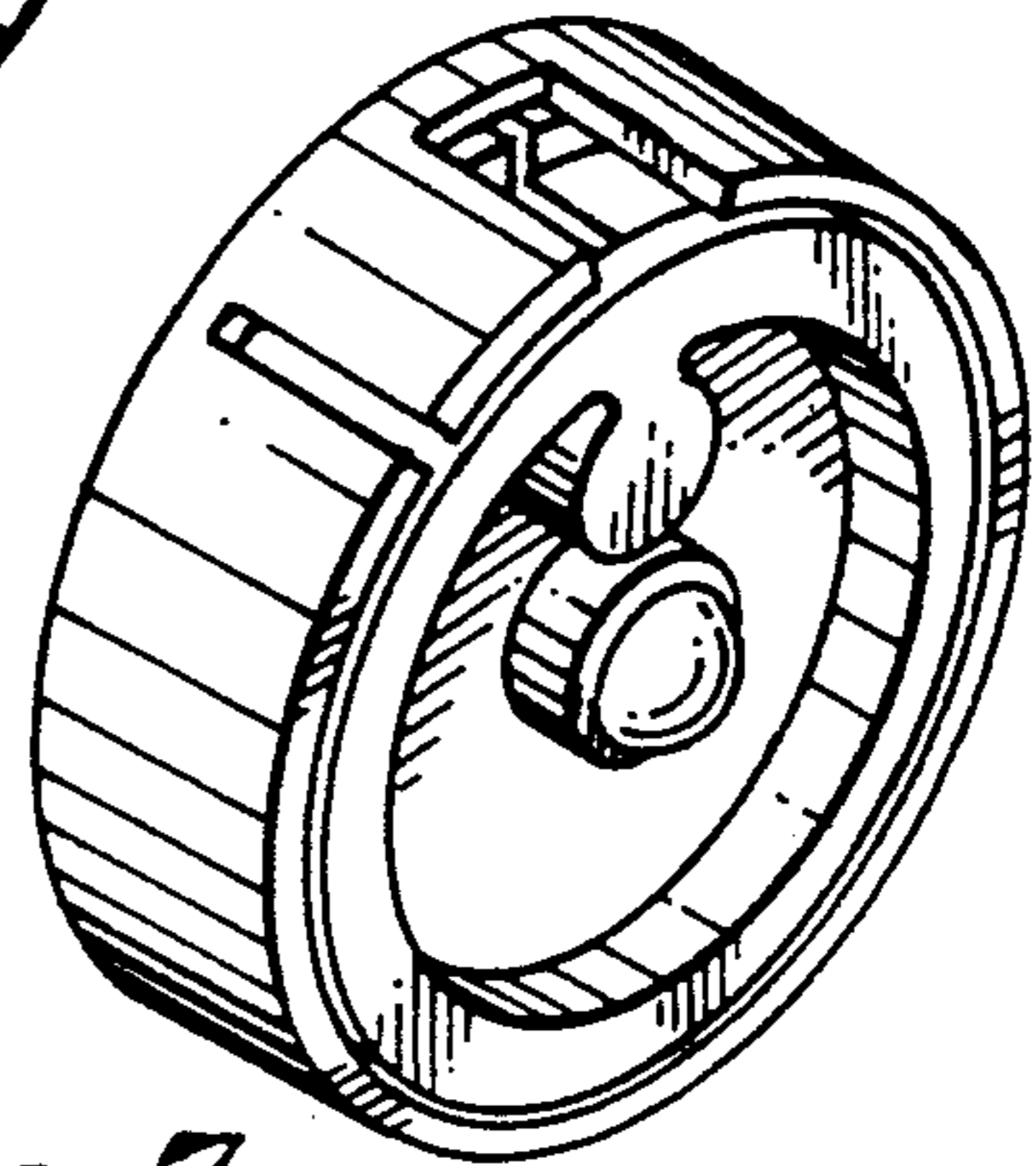

Fig. 7

