



US00D323517S

United States Patent [19]

[11] Patent Number: **Des. 323,517**

Hoeft

[45] Date of Patent: **** Jan. 28, 1992**

[54] **COMBINED APPLICATOR AND REMOVER FOR A CONTACT LENS**

4,338,936 7/1982 Nelson D24/141

[76] Inventor: **Harley E. Hoeft, R.R. 2, Box 401-A, Hardy, Ark. 72542-9552**

FOREIGN PATENT DOCUMENTS

2375004 8/1978 France 294/1.2

[**] Term: **14 Years**

Primary Examiner—A. Hugo Word
Assistant Examiner—Celia A. Murphy
Attorney, Agent, or Firm—Richard C. Litman

[21] Appl. No.: **345,526**

[57] CLAIM

[22] Filed: **May 1, 1989**

The ornamental design for a combined applicator and remover for contact lens, as shown and described.

[52] U.S. Cl. **D16/124; D9/373**

[58] **Field of Search** **D3/30.1, 34; D9/301, D9/338, 373, 374, 375, 376; D16/124; D24/117, 118, 141, 150; D28/7; 215/1 C, 31; 294/1.2; 606/107**

DESCRIPTION

[56] References Cited

U.S. PATENT DOCUMENTS

D. 48,215	11/1915	Zwack	D9/373
D. 237,256	10/1975	Weckman	D9/375
D. 301,836	6/1989	van Lit	D9/301
D. 307,191	4/1990	Blutenthal	D28/7
D. 310,380	9/1990	Yngland	D16/124
4,071,272	1/1978	Drdlik	294/1.2
4,122,142	10/1978	Lawrence et al.	215/1 C
4,201,408	5/1980	Tressel	294/1.2

FIG. 1 is a top plan view of a combined applicator and remover for a contact lens showing my new design; FIG. 2 is a left side elevational view thereof; FIG. 3 is a right side elevational view thereof; FIG. 4 is a front elevational view thereof, the rear being a mirror image; FIG. 5 is a bottom plan view thereof; FIG. 6 is a perspective view thereof; and FIG. 7 is a sectional view taken on line 7—7 of FIG. 1 showing the design in the position of use, and the broken lines showing a contact lens and case being for illustrative purposes only and claiming no part of the claimed design.

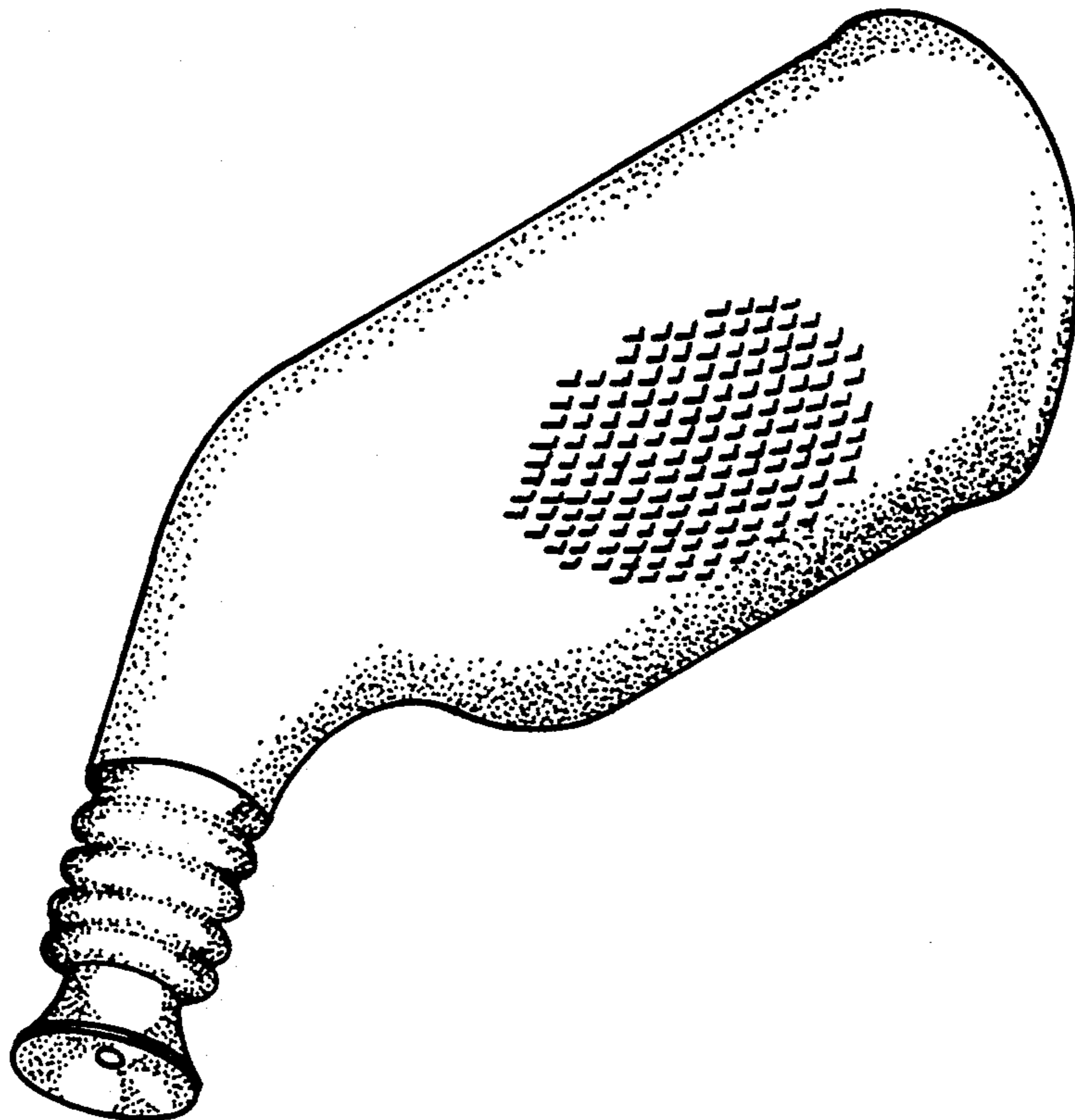

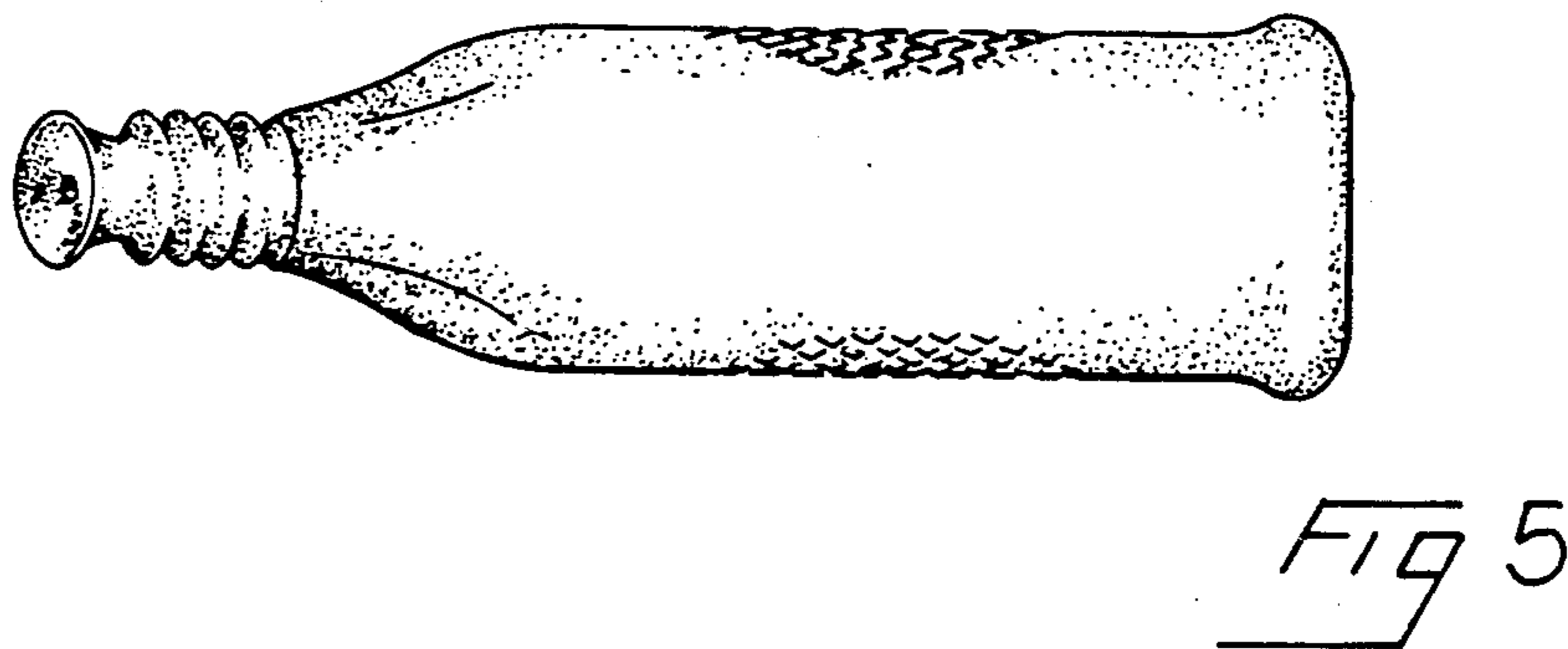
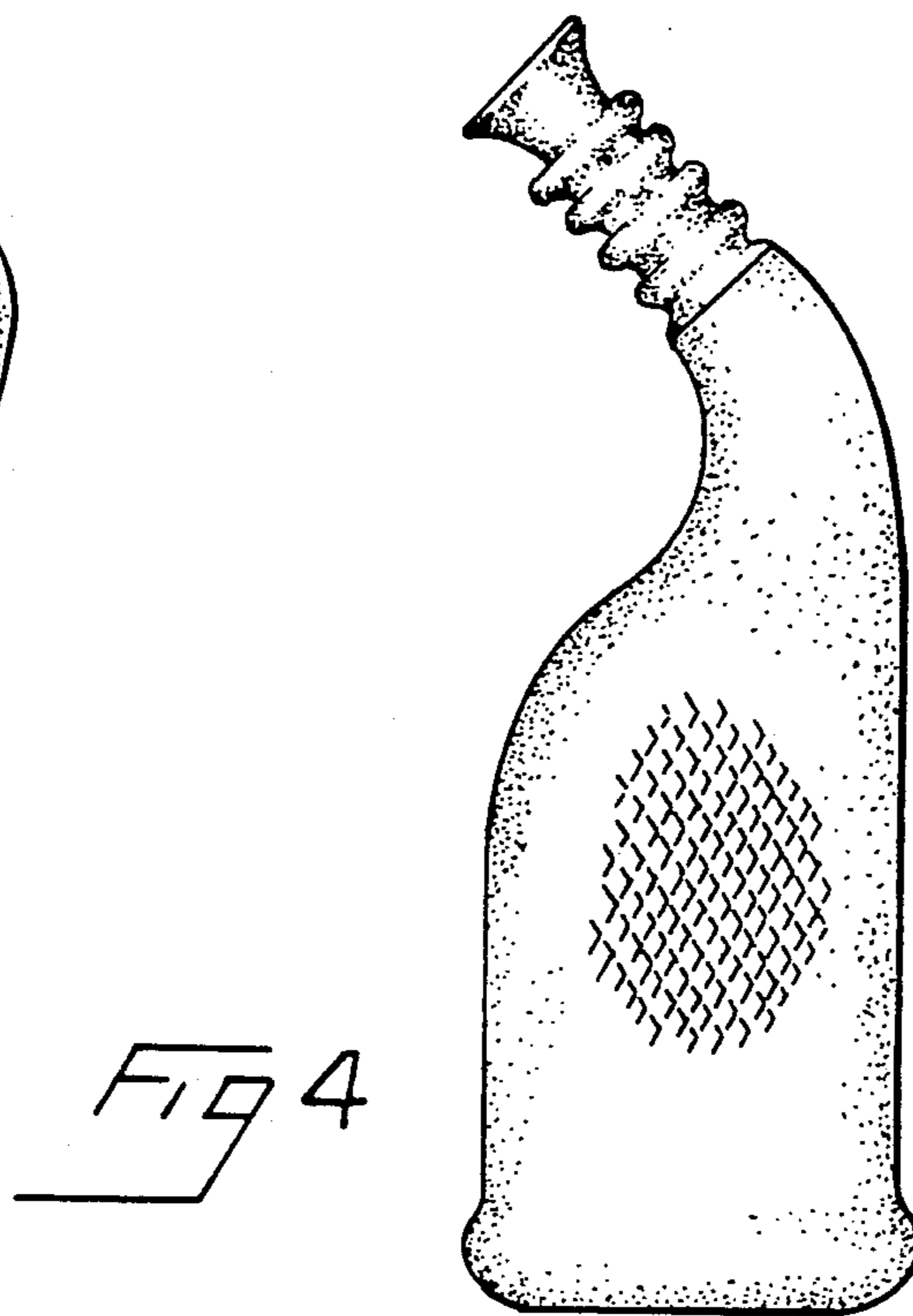
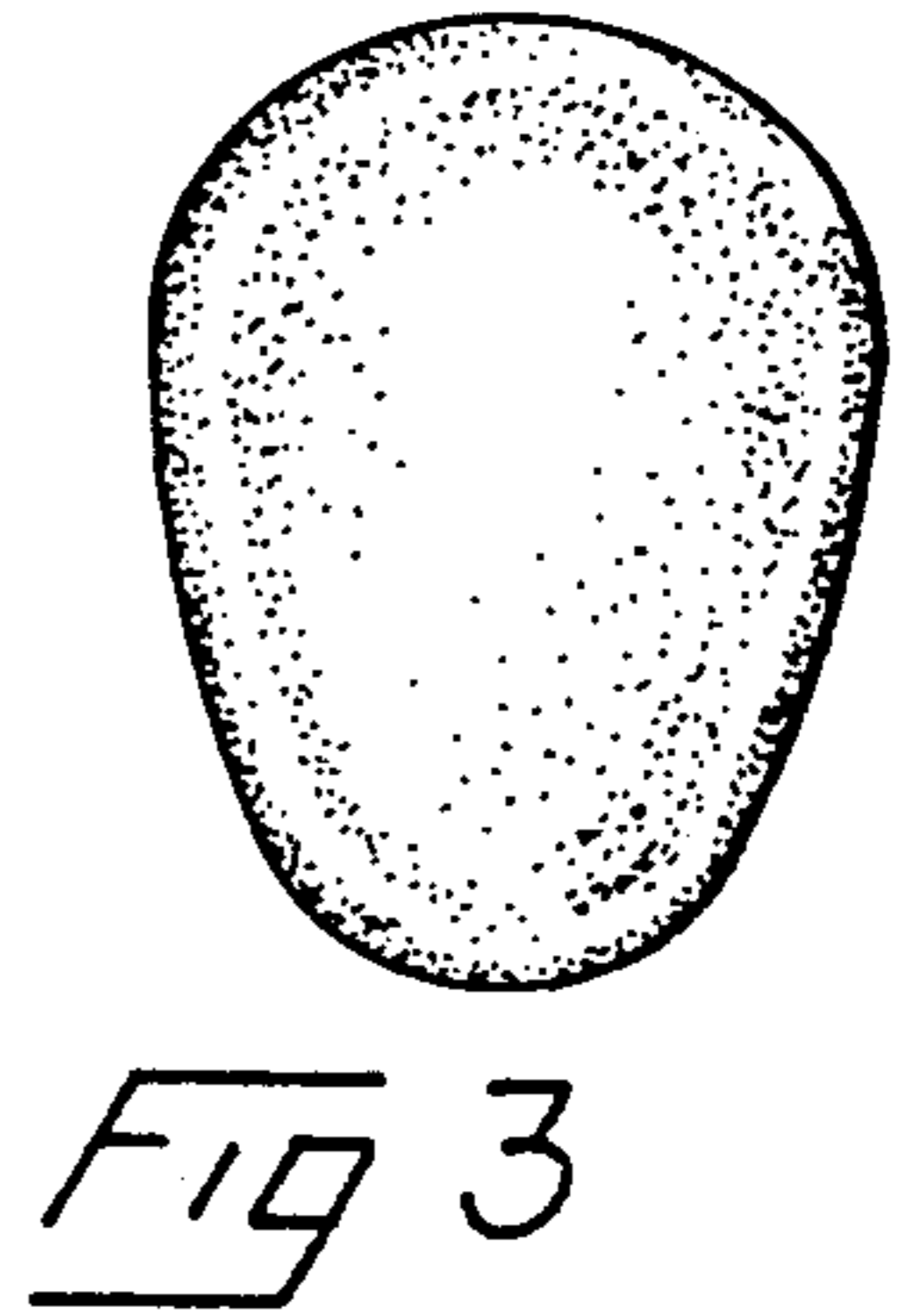
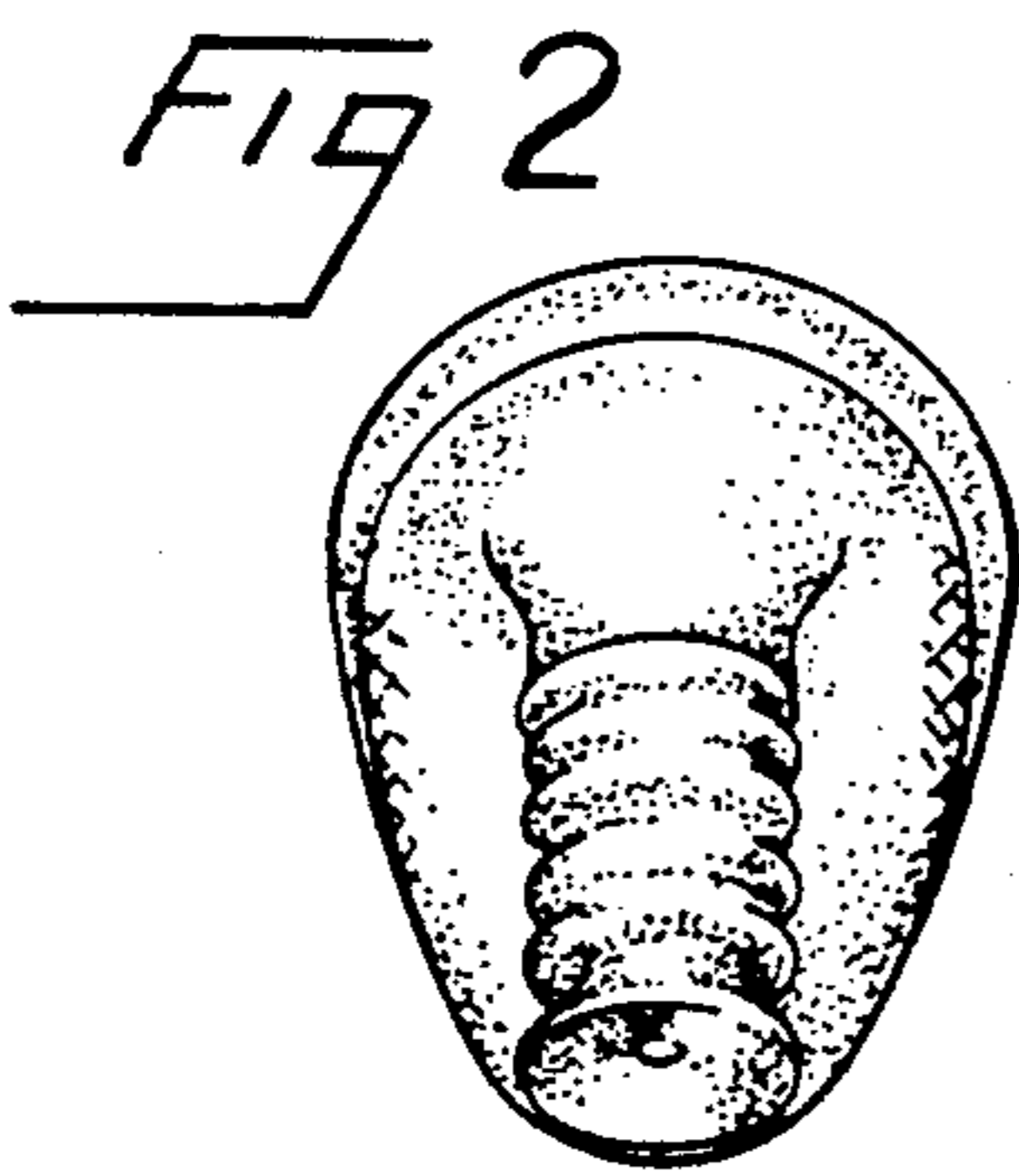
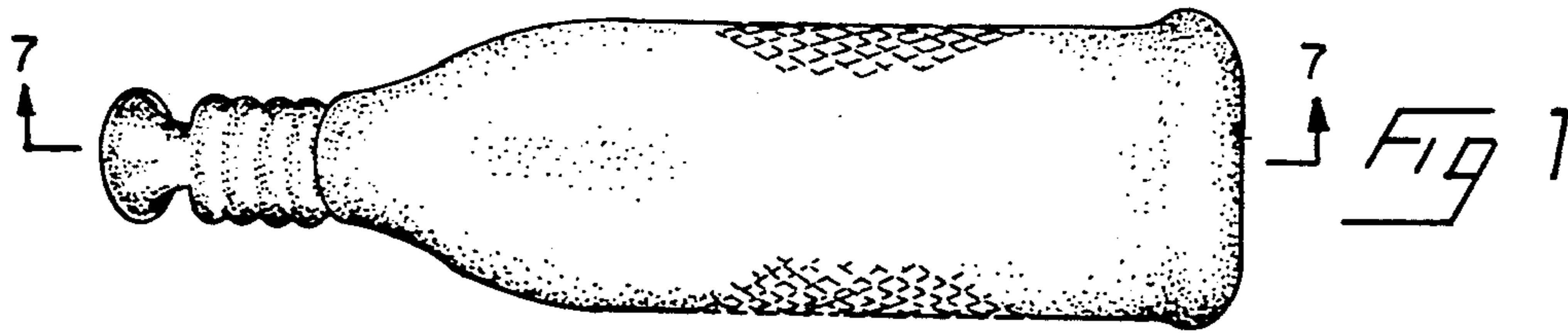

FIG. 6

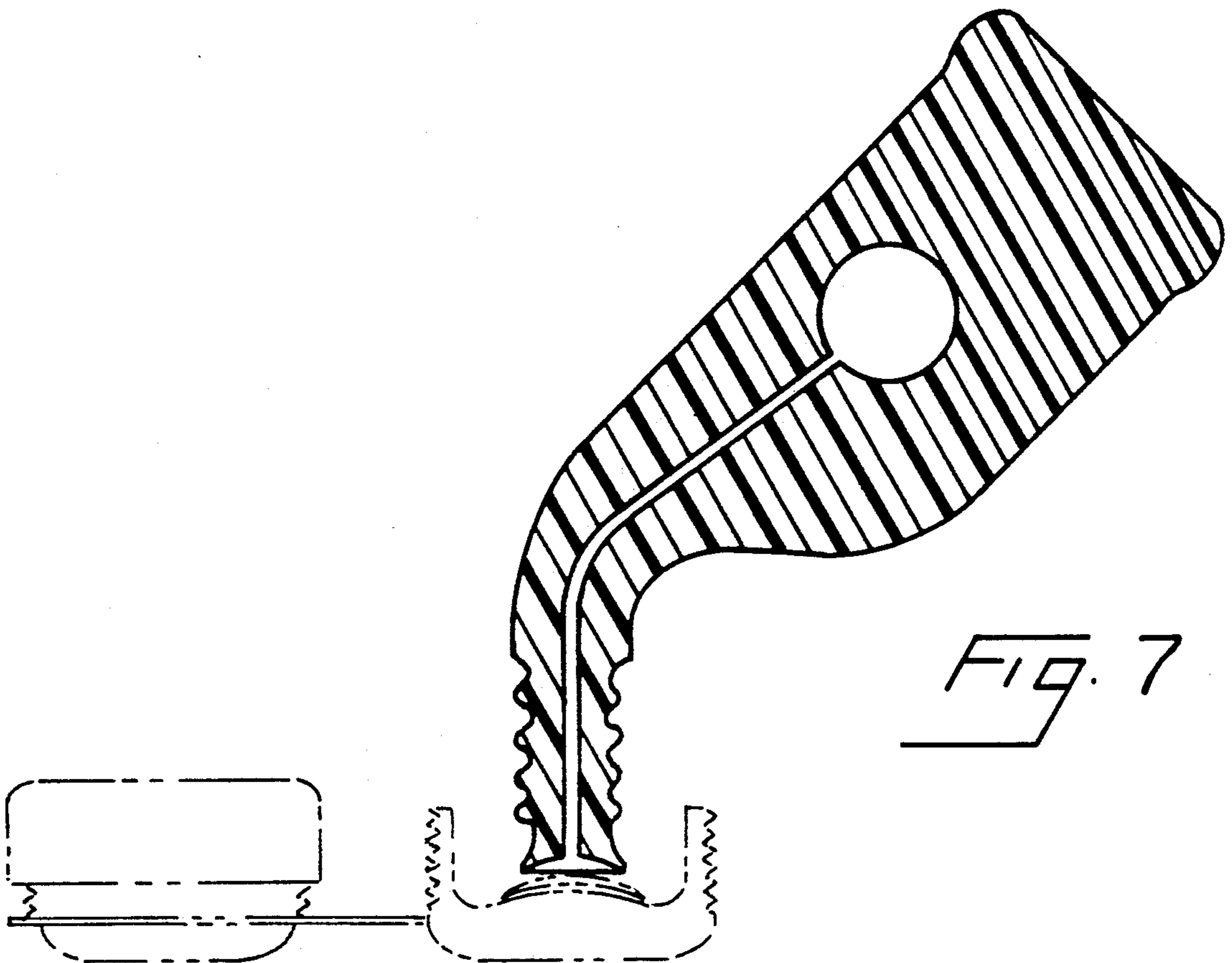
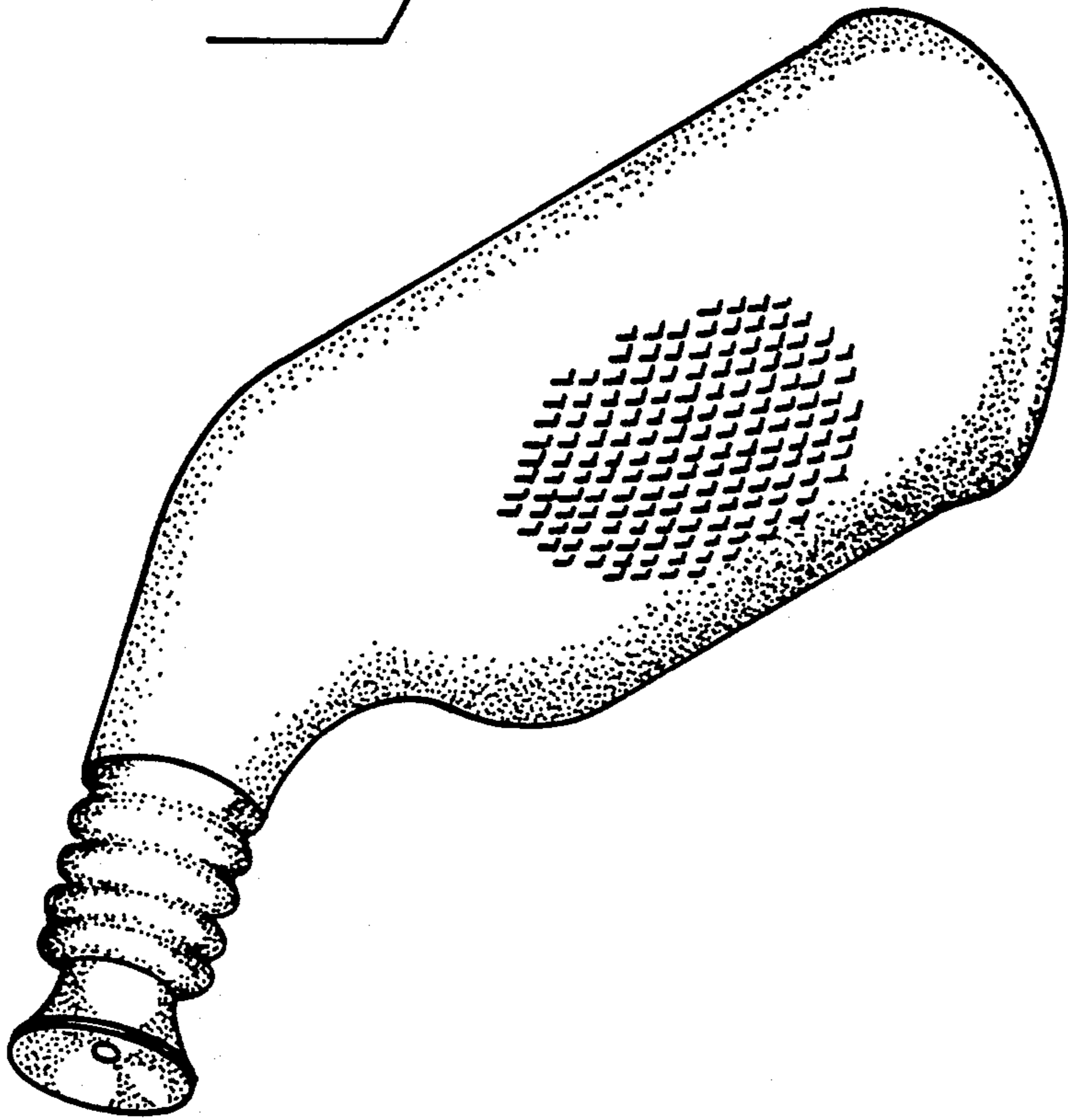

FIG. 7