



US00D323513S

United States Patent [19]

van Asten

[11] Patent Number: **Des. 323,513**

[45] Date of Patent: **** Jan. 28, 1992**

[54] ICE CREAM MAKER

[56] References Cited

[75] Inventor: **Jan F. van Asten,**
Wölfnitz-Klagenfurt, Austria

U.S. PATENT DOCUMENTS

D. 254,972	5/1980	Rakocy et al.	D15/82
D. 293,448	12/1987	Uesaka	D15/82
D. 296,749	7/1988	Threadgill, Jr. et al.	D15/82
5,022,315	6/1991	Bertram	62/342

[73] Assignee: **U.S. Philips Corporation,** New York,
N.Y.

Primary Examiner—Bernard Ansher
Assistant Examiner—Sandra Morris
Attorney, Agent, or Firm—Jack E. Haken

[**] Term: **14 Years**

[57] CLAIM

[21] Appl. No.: **515,157**

The ornamental design for an ice cream maker, as shown.

[22] Filed: **Apr. 26, 1990**

DESCRIPTION

[30] Foreign Application Priority Data

Nov. 6, 1989 [WO] World Int. Prop. O. ... DM/014.993
 [52] U.S. Cl. D15/82
 [58] Field of Search D7/376; D15/81, 82;
 62/340-344, 371; 366/244

FIG. 1 is a perspective view of an ice cream maker, showing my new design;
 FIG. 2 is a front elevational view thereof;
 FIG. 3 is a rear elevational view thereof;
 FIG. 4 is a right side elevational view thereof;
 FIG. 5 is a left side elevational view thereof;
 FIG. 6 is a top plan view thereof; and
 FIG. 7 is a bottom plan view thereof.

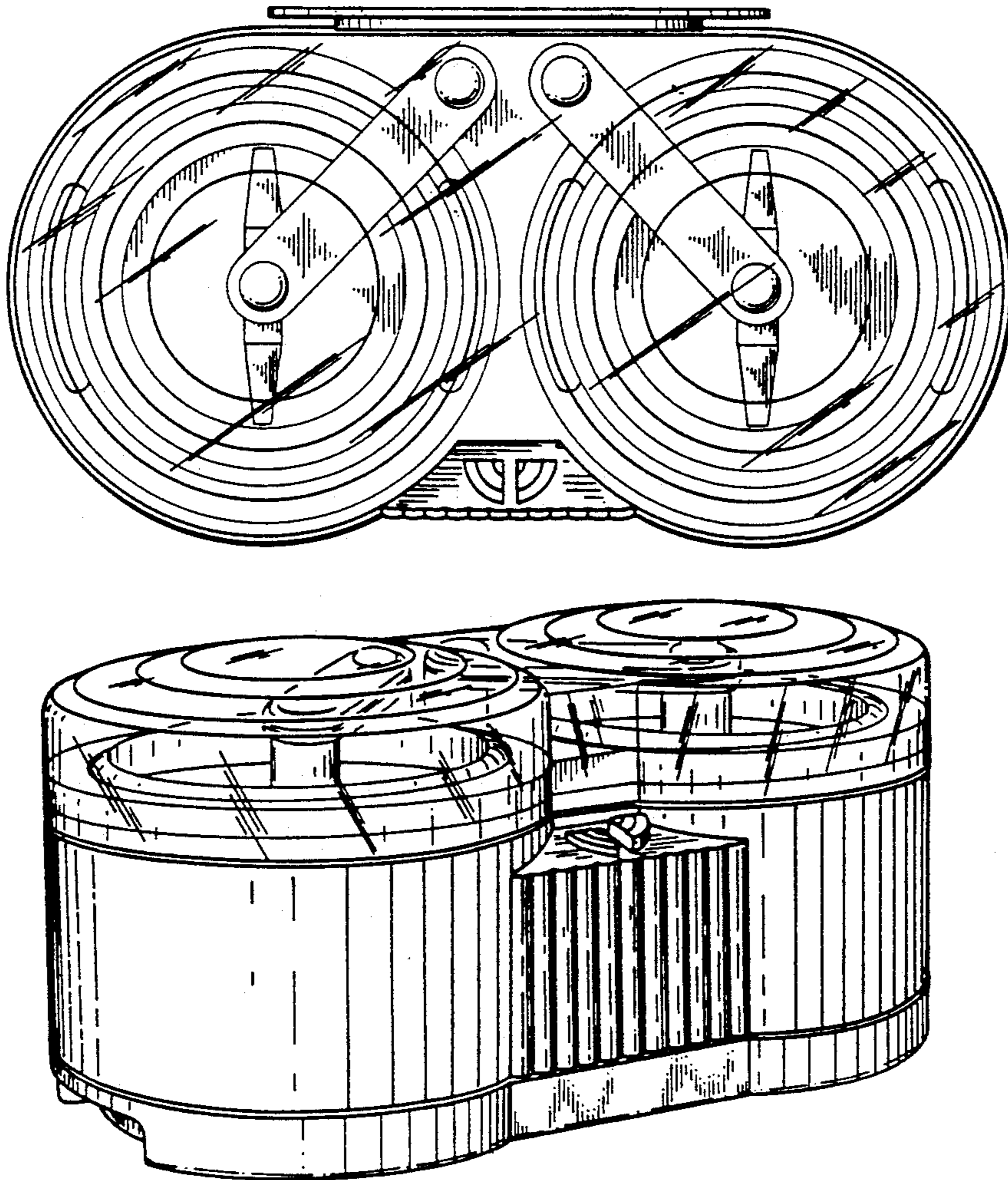

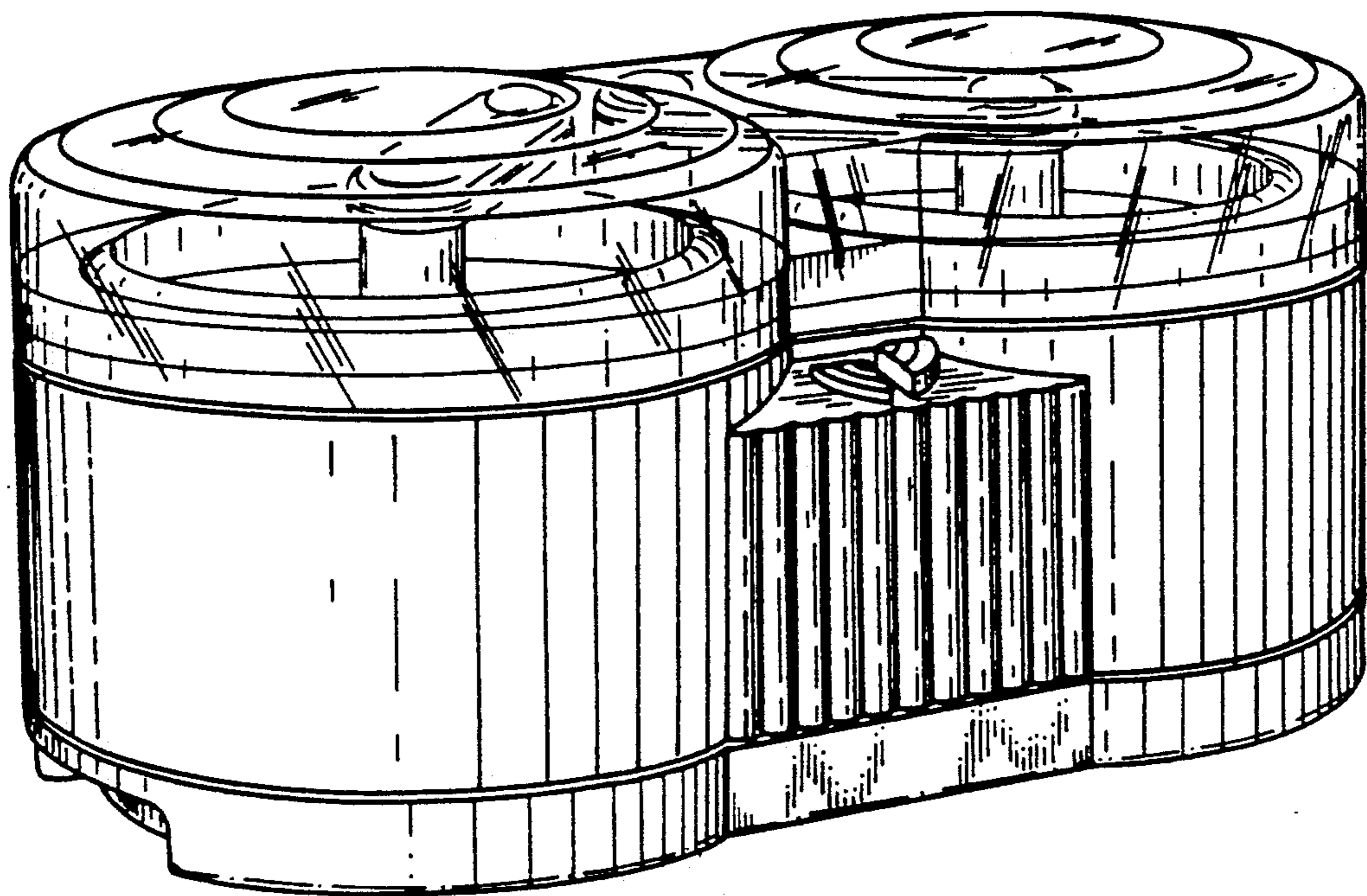

FIG. 1

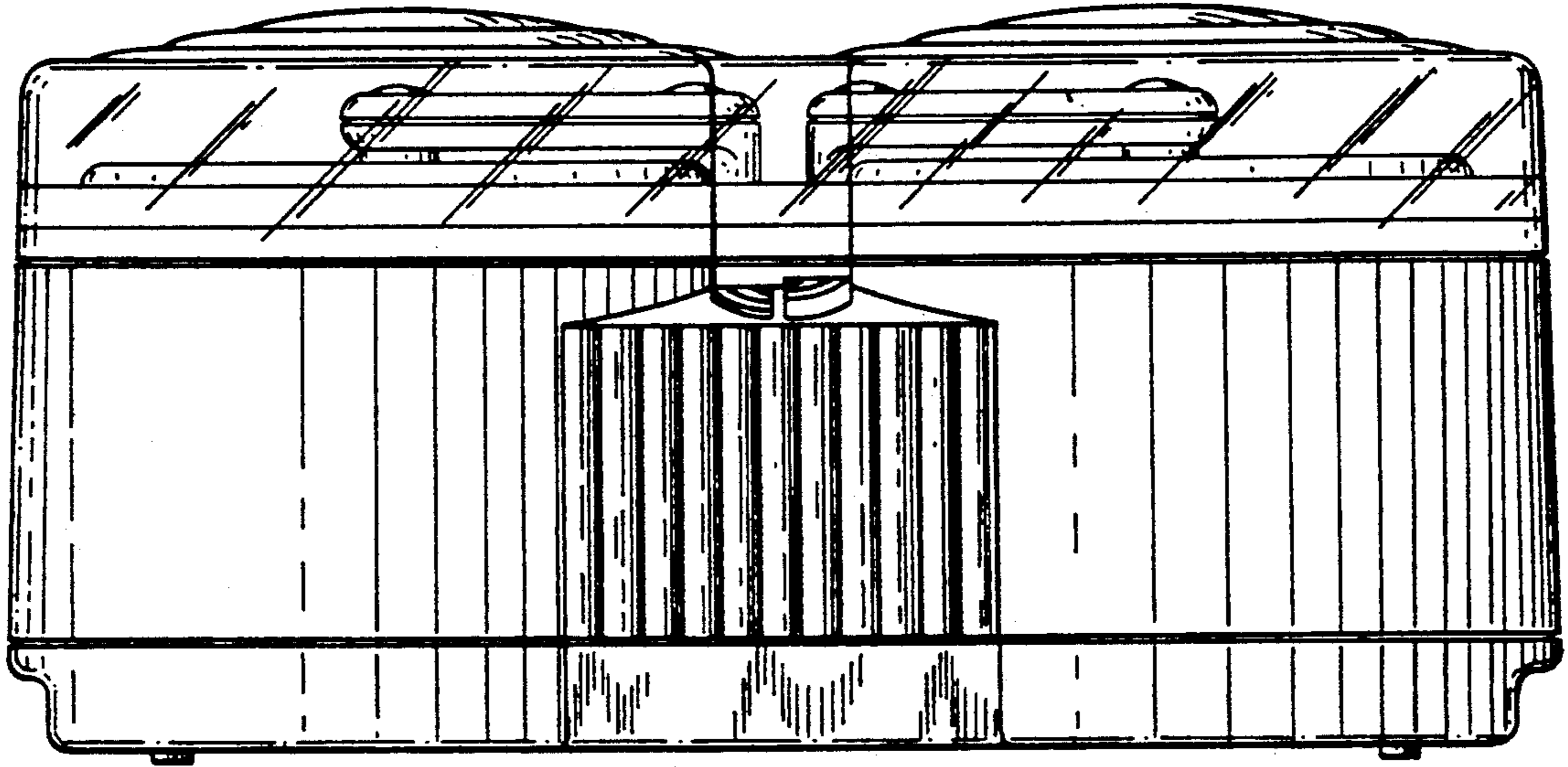

FIG. 2

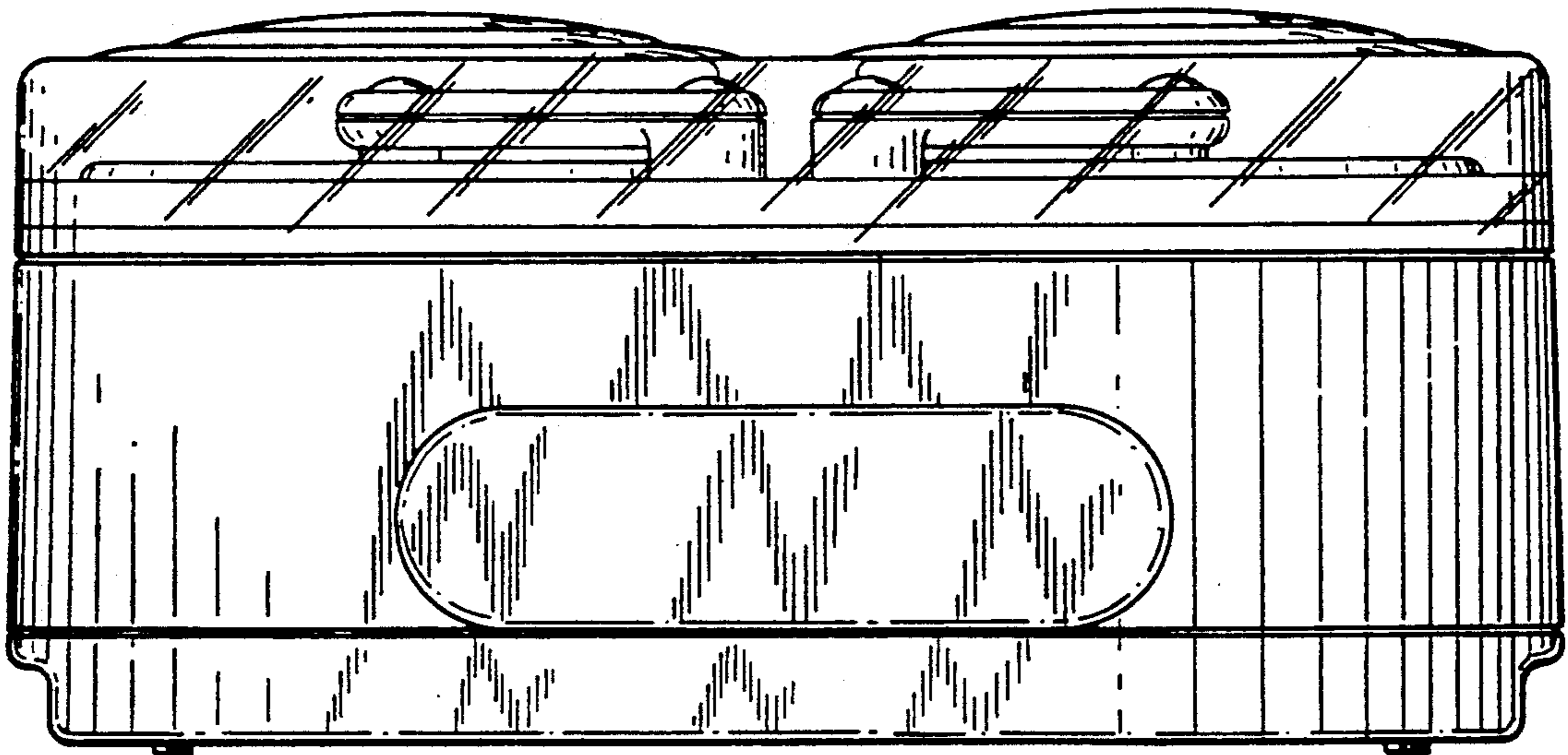

FIG. 3

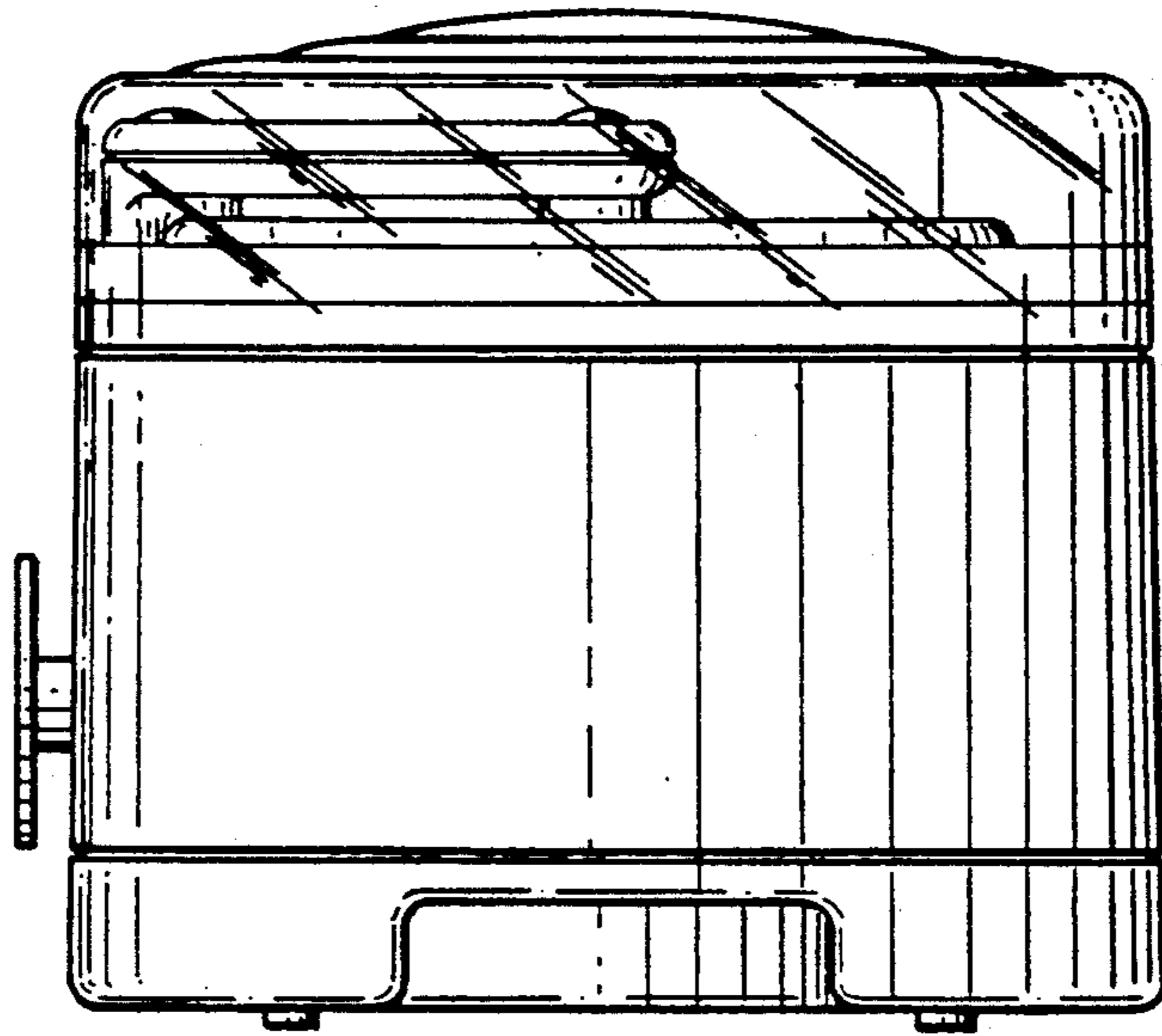

FIG. 4

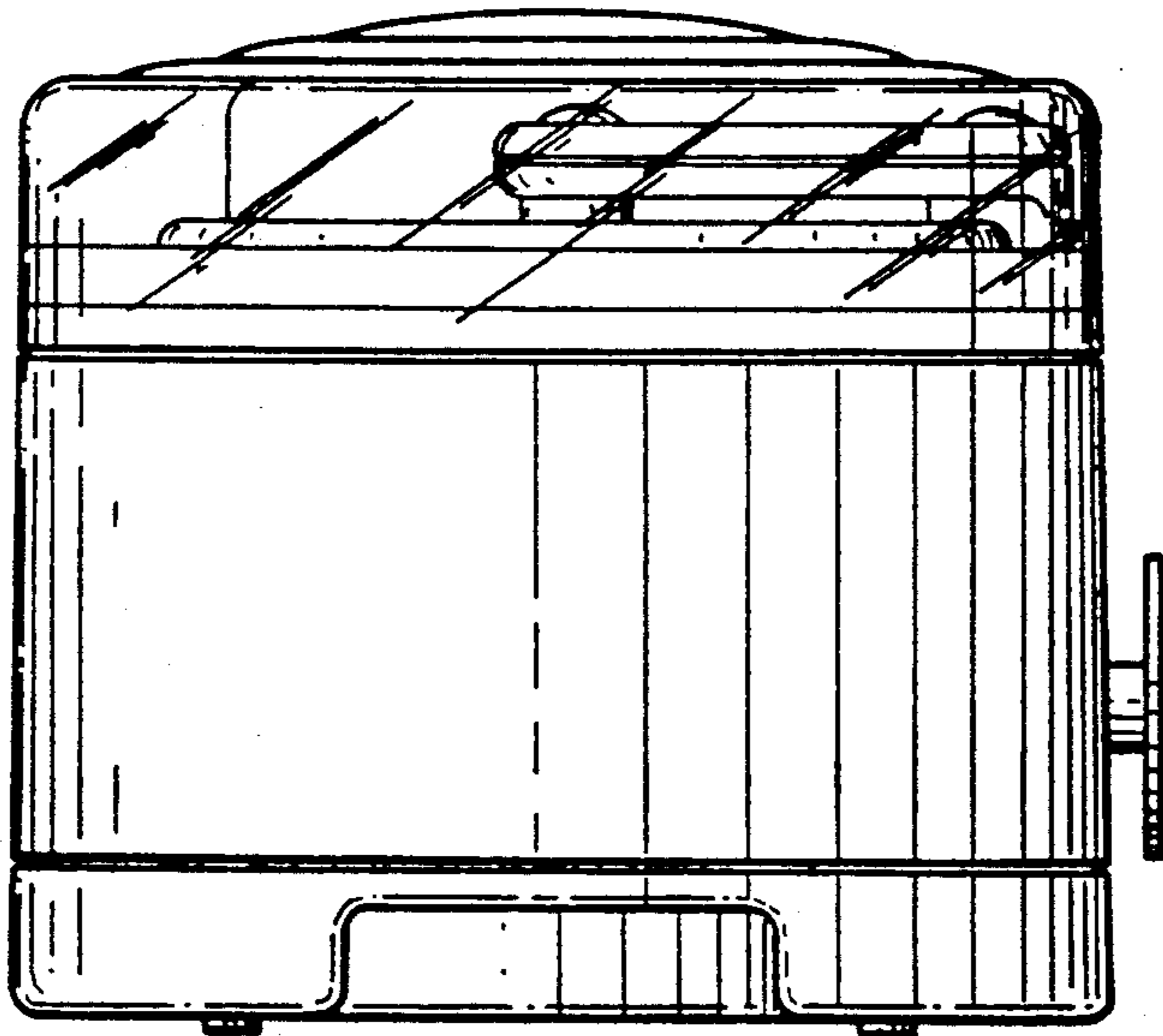

FIG. 5

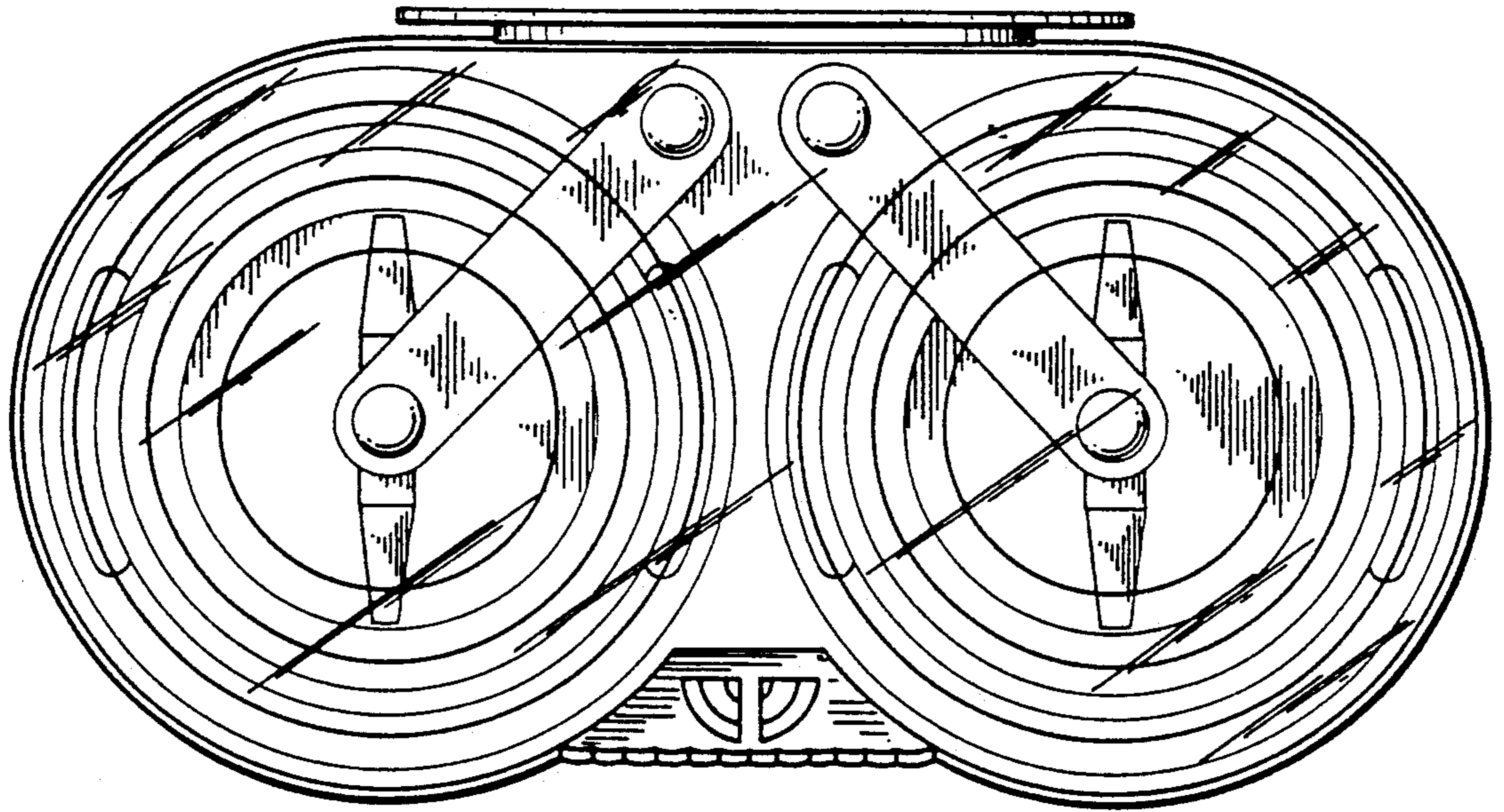

FIG. 6

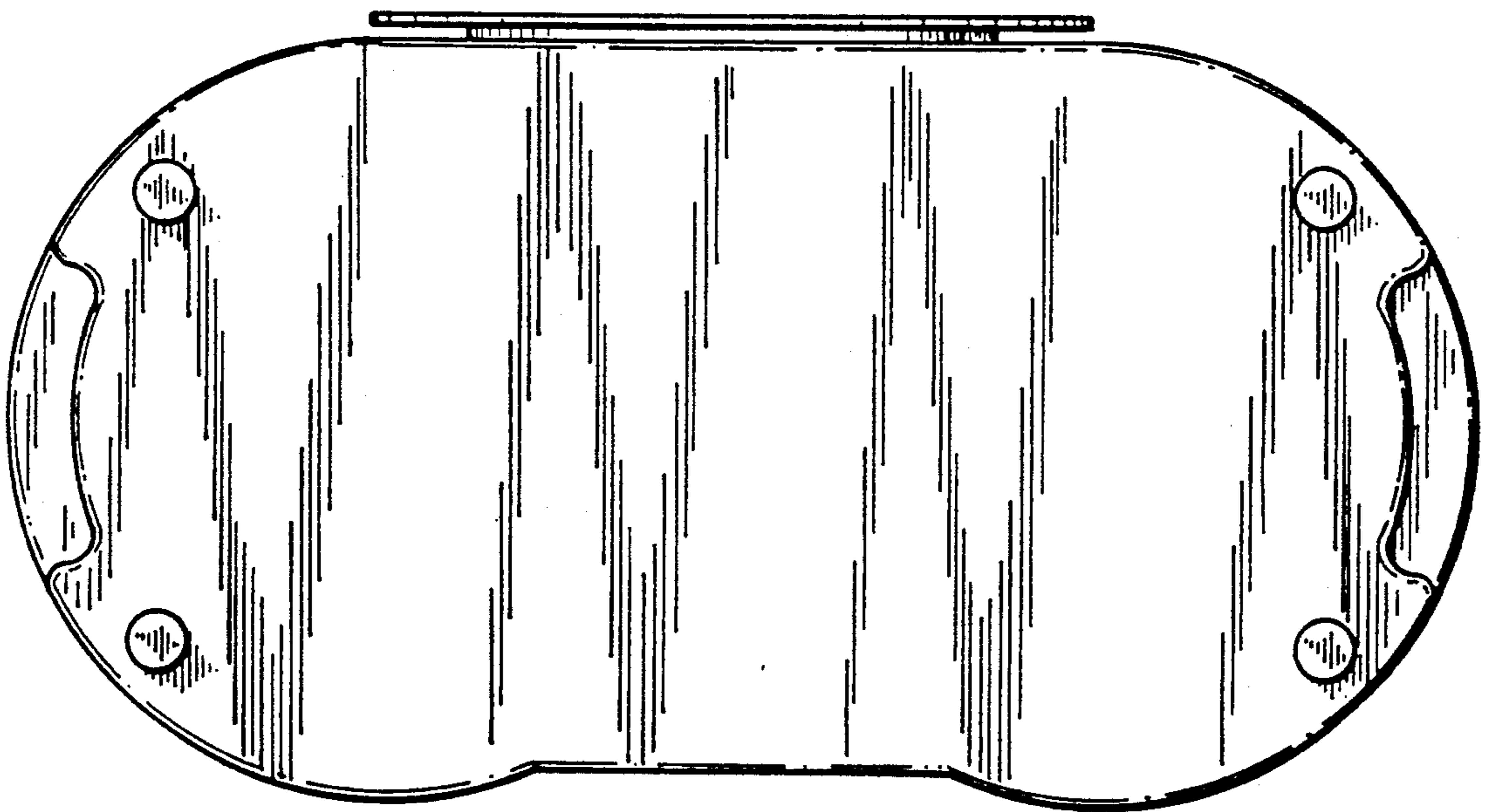

FIG. 7