



US00D323450S

# United States Patent [19]

Shimizu

[11] Patent Number: **Des. 323,450**

[45] Date of Patent: **\*\* Jan. 28, 1992**

[54] **KNIVE SHARPENER**

[76] Inventor: **Kiyoshi Shimizu, 3-7-75 Suehiro, Miki-shi, Hyogo-ken, Japan**

[\*\*] Term: **14 Years**

[21] Appl. No.: **324,891**

[22] Filed: **Mar. 14, 1989**

[30] **Foreign Application Priority Data**

Sep. 16, 1988 [JP] Japan ..... 63-36496

[52] U.S. Cl. .... **D8/93**

[58] Field of Search ..... **D8/91, 92, 93; 51/214, 51/205 WG, 173, 211 R, 211 H; 76/82, 83**

[56] **References Cited**

**U.S. PATENT DOCUMENTS**

- D. 173,204 10/1954 Hussar ..... D8/93
- D. 276,886 12/1984 Carter ..... D8/91
- D. 299,308 1/1989 Prindle ..... D8/93
- D. 304,414 7/1990 Shimizu ..... D8/93

- D. 309,415 7/1990 Shimizu ..... D8/93
- D. 315,663 3/1991 Dolbosco ..... D8/93

*Primary Examiner*—Bernard Ansher  
*Assistant Examiner*—Philip Hyder  
*Attorney, Agent, or Firm*—Bruce L. Adams; Van C. Wilks

[57] **CLAIM**

The ornamental design for a knife sharpener, as shown and described.

**DESCRIPTION**

FIG. 1 is a top plan view of a knife sharpener showing my new design;  
FIG. 2 is a right side elevational view thereof, the left side being the same in appearance as the right side;  
FIG. 3 is a rear elevational view thereof;  
FIG. 4 is a front elevational view thereof;  
FIG. 5 is a bottom plan view thereof;  
FIG. 6 is a sectional view thereof taken along line 6—6 of FIG. 2; and  
FIG. 7 is a right, top perspective view thereof.

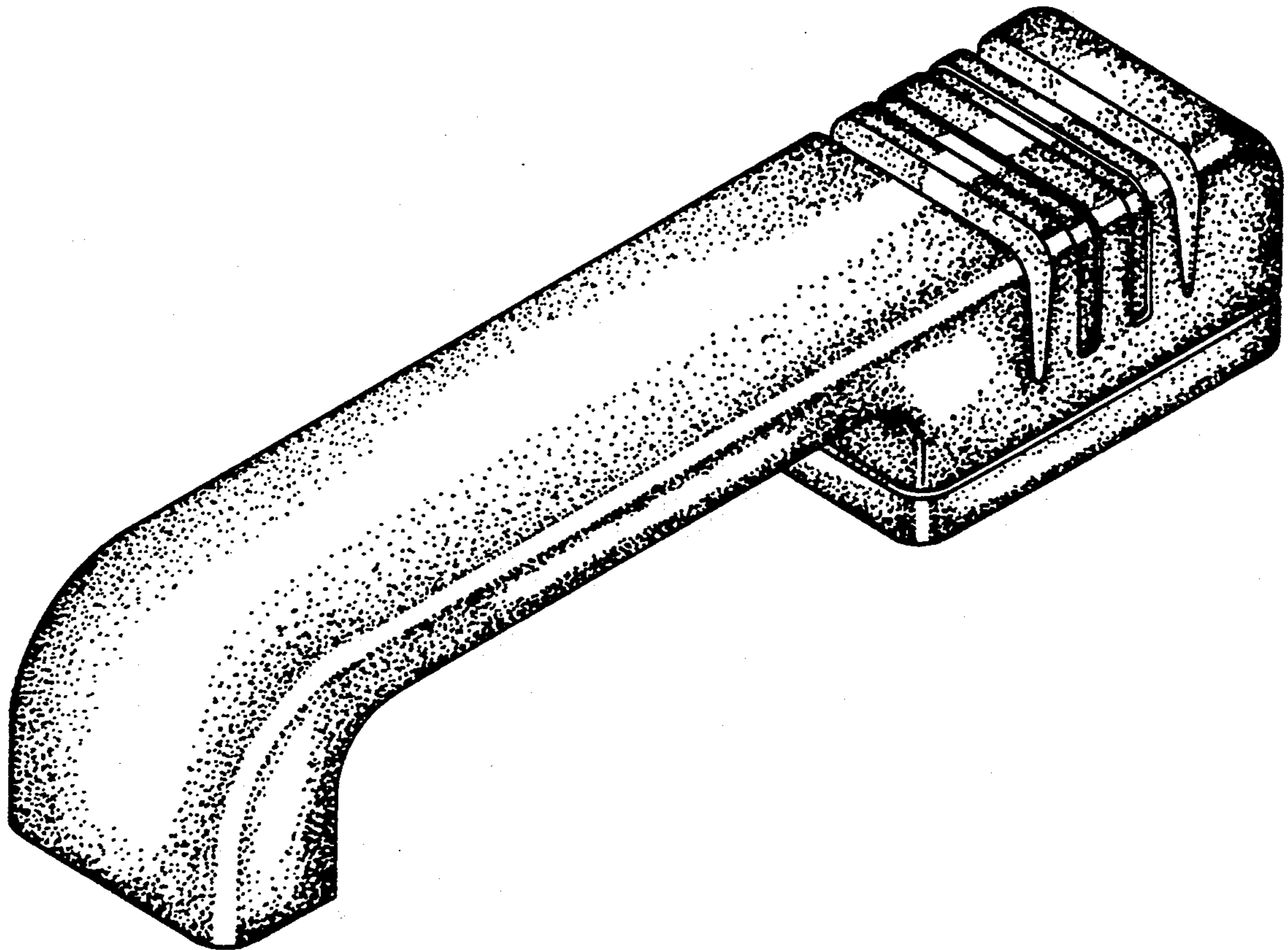

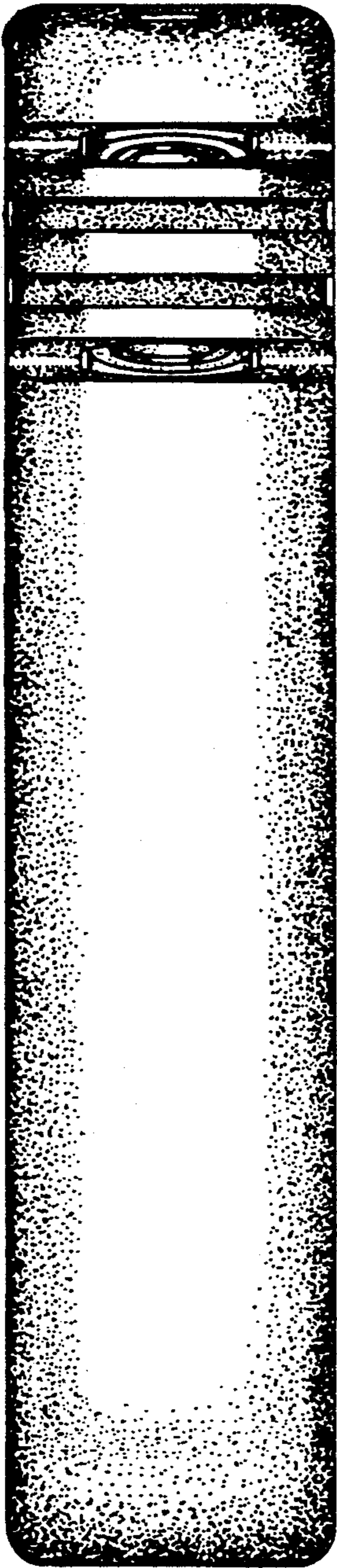

FIG. 1

6 ↙

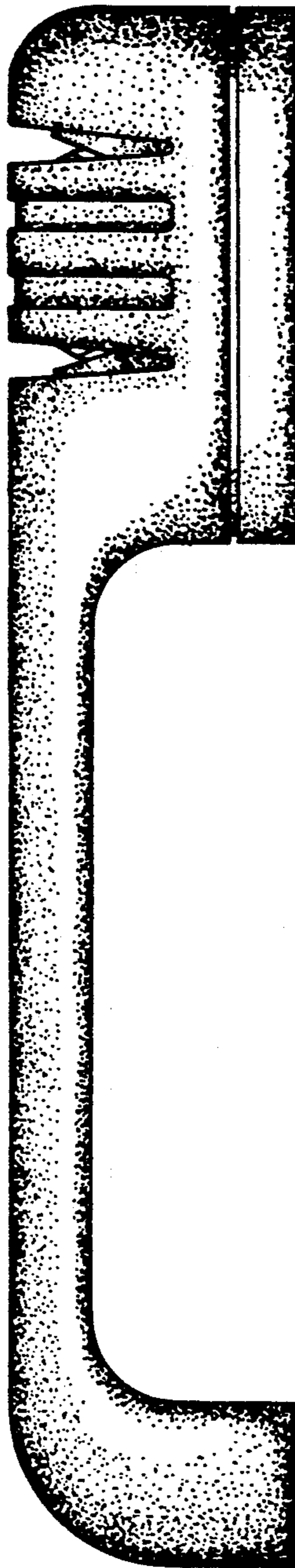

FIG. 2

6 ↙

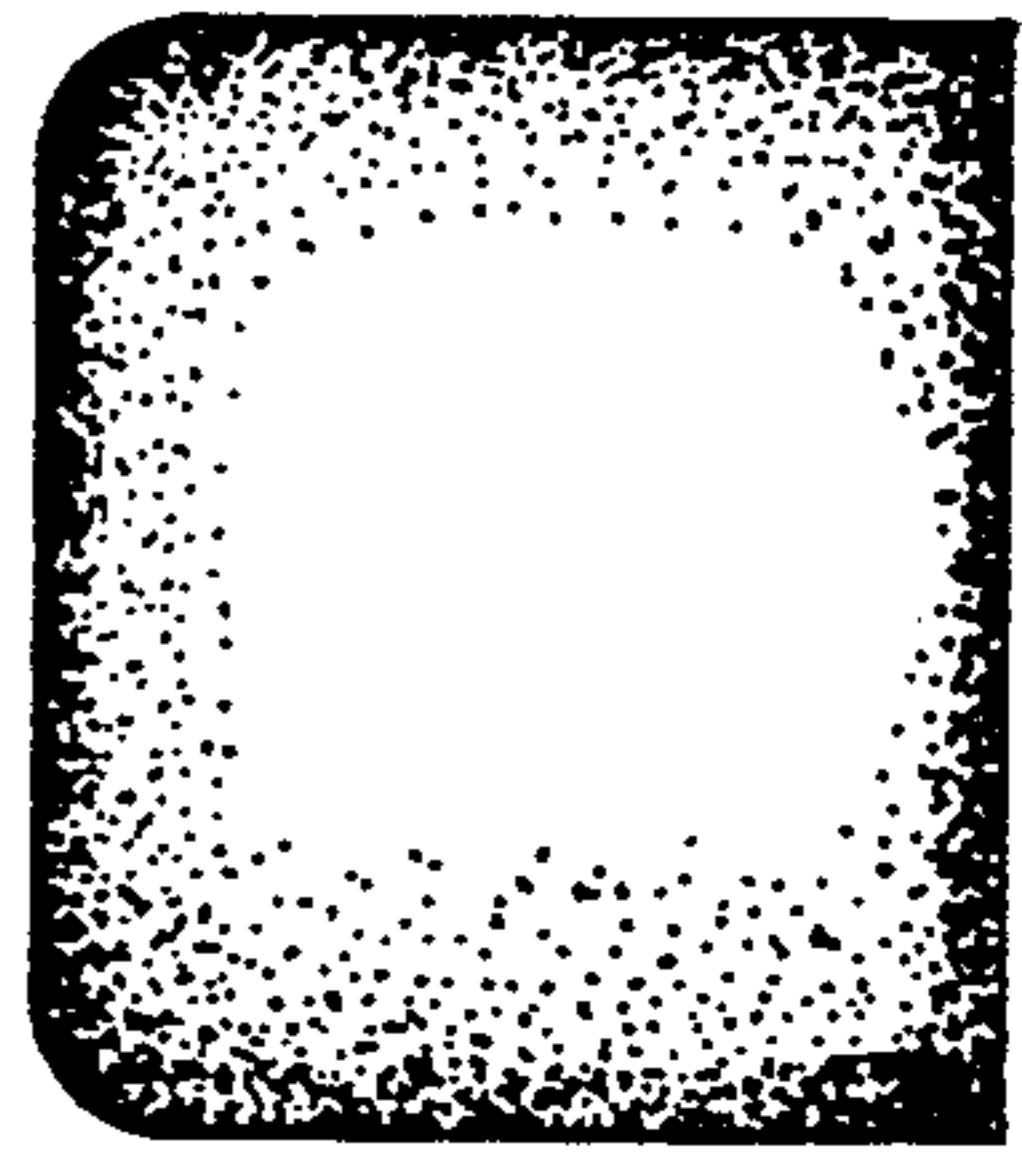

FIG. 3

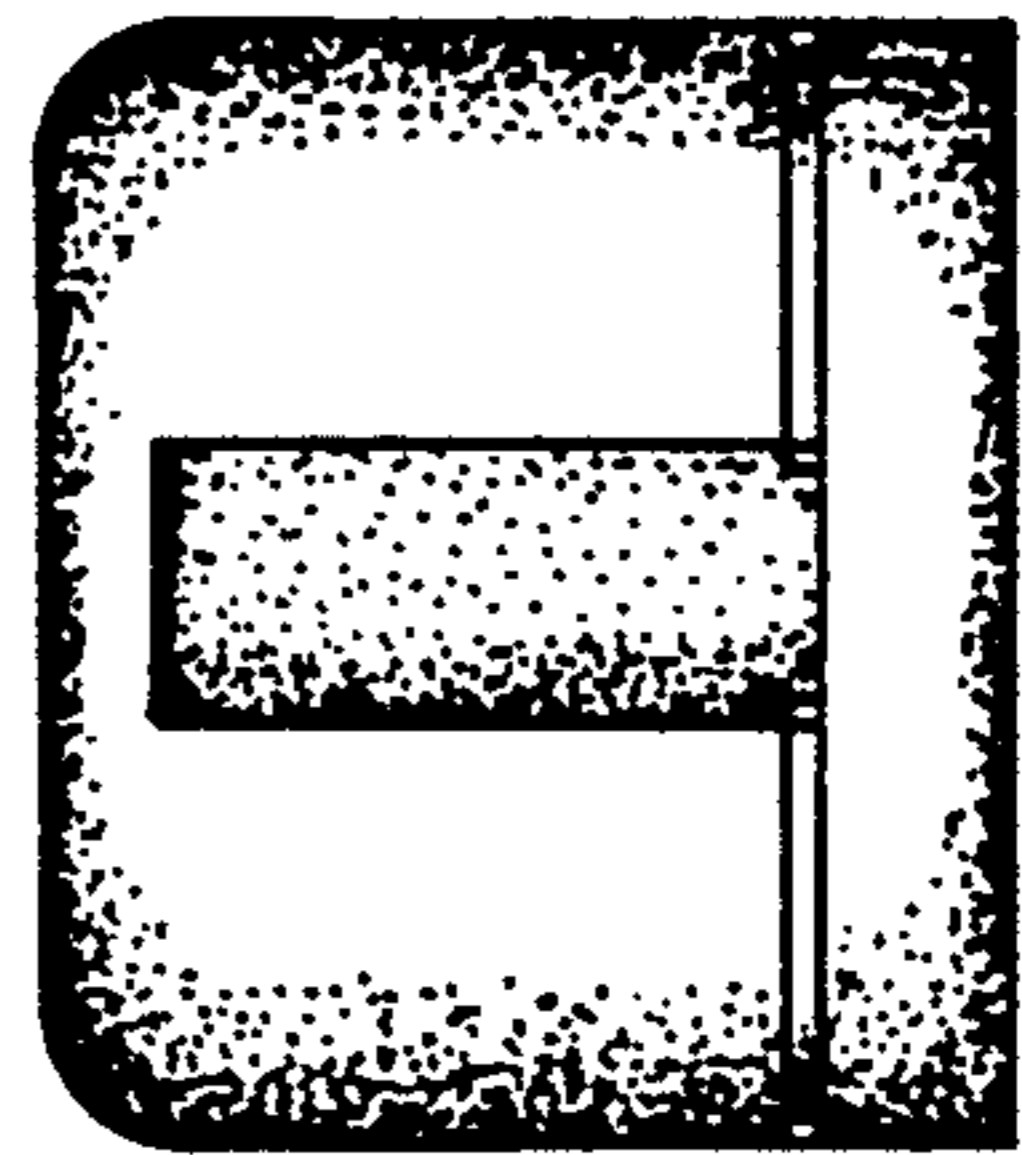

FIG. 4



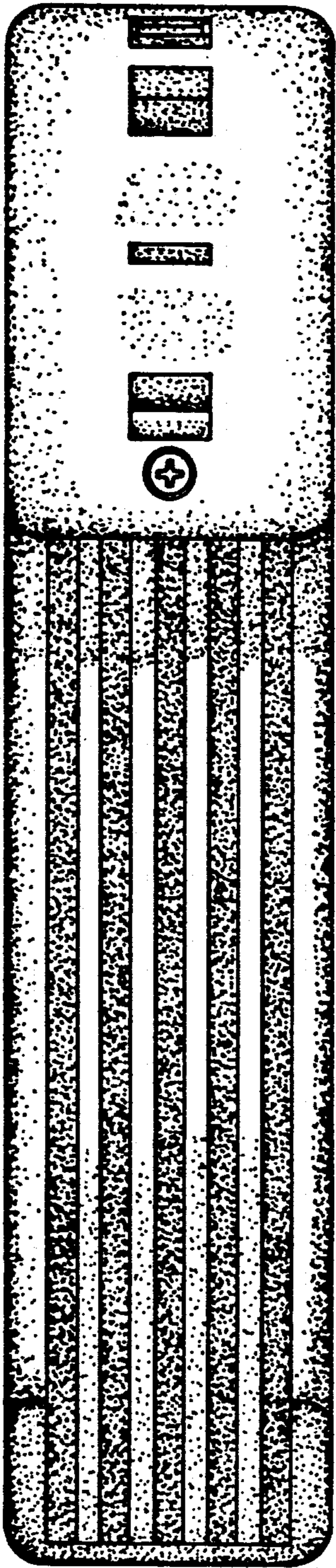

FIG. 5

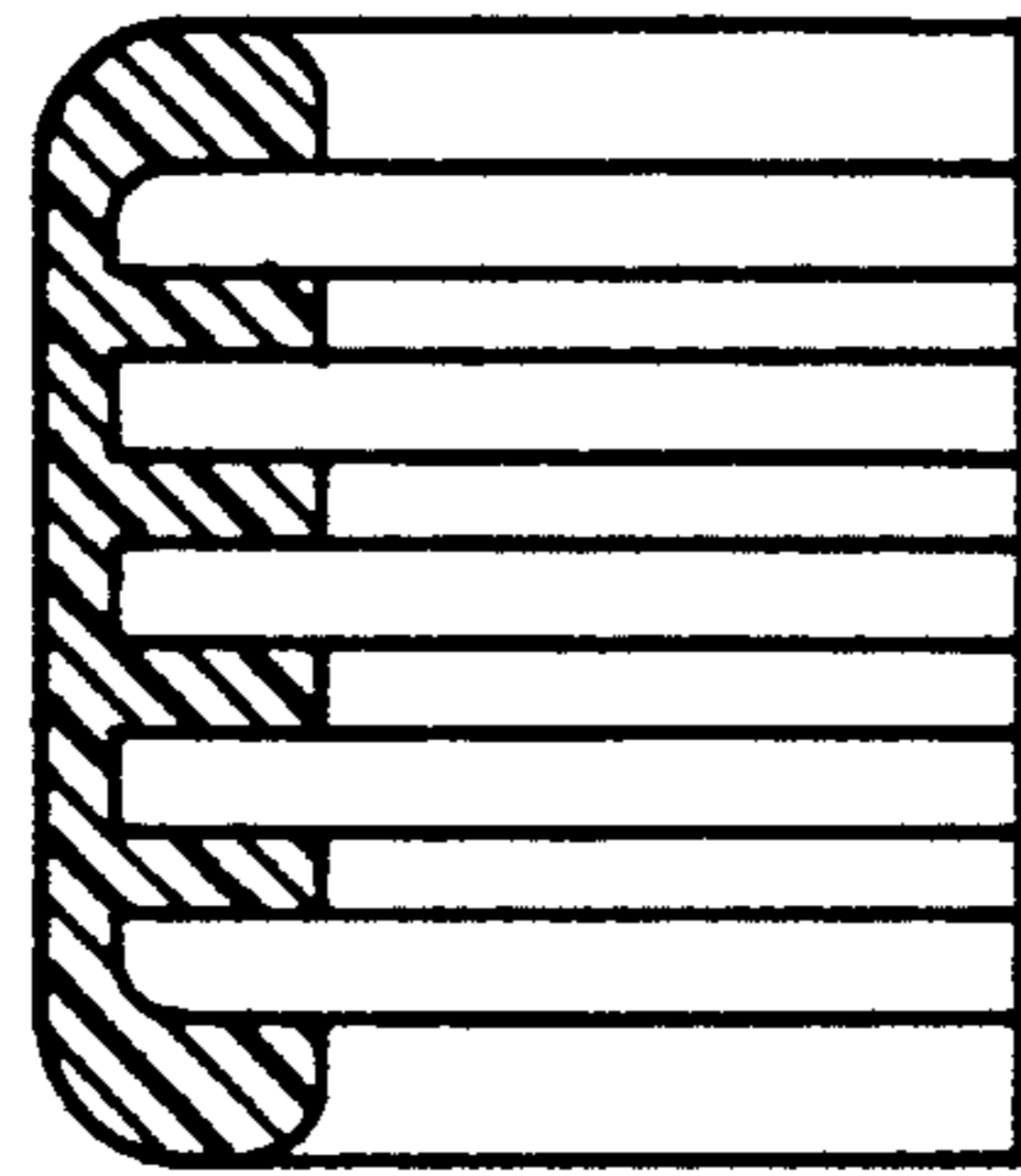

FIG. 6

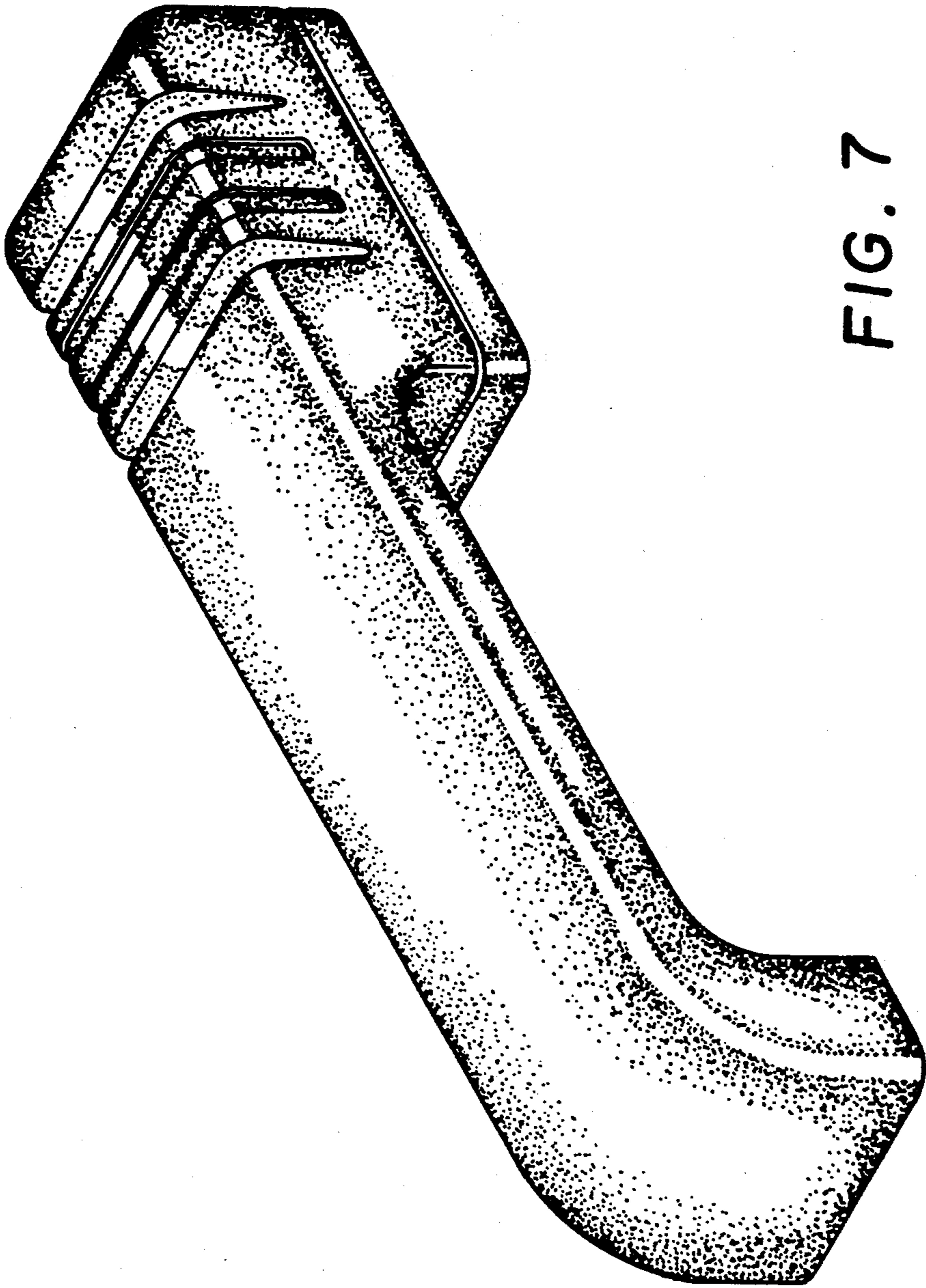

FIG. 7