



US00D323397S

# United States Patent [19]

[11] Patent Number: **Des. 323,397**

**Mann**

[45] Date of Patent: **\*\* Jan. 21, 1992**

[54] **DENTAL IMPRESSION TRAY FOR SMALL ANIMALS**

[76] Inventor: **Lloyd J. Mann, 2040 S. 327th La., #DD201, Federal Way, Wash. 98003**

[\*\*] Term: **14 Years**

[21] Appl. No.: **556,974**

[22] Filed: **Jul. 24, 1990**

[52] U.S. Cl. .... **D24/181**

[58] Field of Search ..... **D24/176-182; 433/1, 34, 36-39, 44, 213-214**

[56] **References Cited**

**U.S. PATENT DOCUMENTS**

D. 281,532	11/1985	Wwissman	.....	D24/181
D. 315,209	5/1991	Mann	.....	D24/181
D. 315,955	4/1991	Mann	.....	D24/181
3,234,942	2/1966	Simon	.....	D24/176 X
3,236,235	2/1966	Jacobs	.....	D24/176 X

*Primary Examiner*—Susan J. Lucas  
*Assistant Examiner*—M. H. Tung  
*Attorney, Agent, or Firm*—James F. Duffy

[57] **CLAIM**

The ornamental design for a dental impression tray for small animals, as shown and described.

**DESCRIPTION**

FIG. 1 is a top side, perspective view of a dental impression tray for small animals showing my new design; FIG. 2 is a rear elevational view thereof; FIG. 3 is a front elevational view thereof; FIG. 4 is an opposite side elevational view thereof; FIG. 5 is a top plan view thereof; FIG. 6 is a bottom plan view thereof; FIG. 7 is a top, side perspective view of a second embodiment thereof; FIG. 8 is a rear elevational view thereof; FIG. 9 is a front elevational view thereof; FIG. 10 is an opposite side elevational view thereof; FIG. 11 is a top plan view thereof; FIG. 12 is a bottom plan view thereof; FIG. 13 is a top, side perspective view of a third embodiment thereof; FIG. 14 is a rear elevational view thereof; FIG. 15 is a front elevational view thereof; FIG. 16 is an opposite side elevational view thereof; FIG. 17 is a top plan view thereof; and FIG. 18 is a bottom plan view thereof.

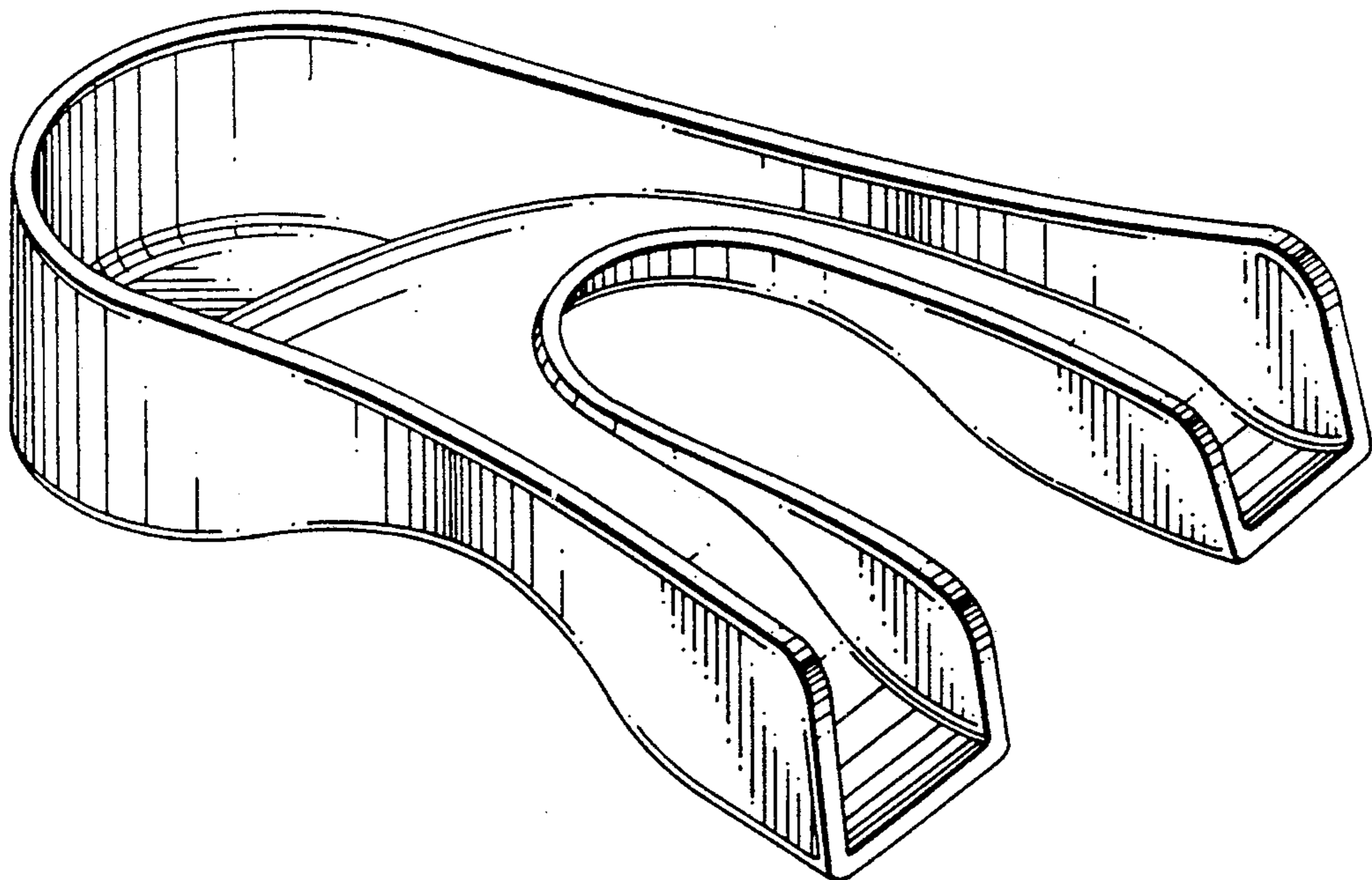

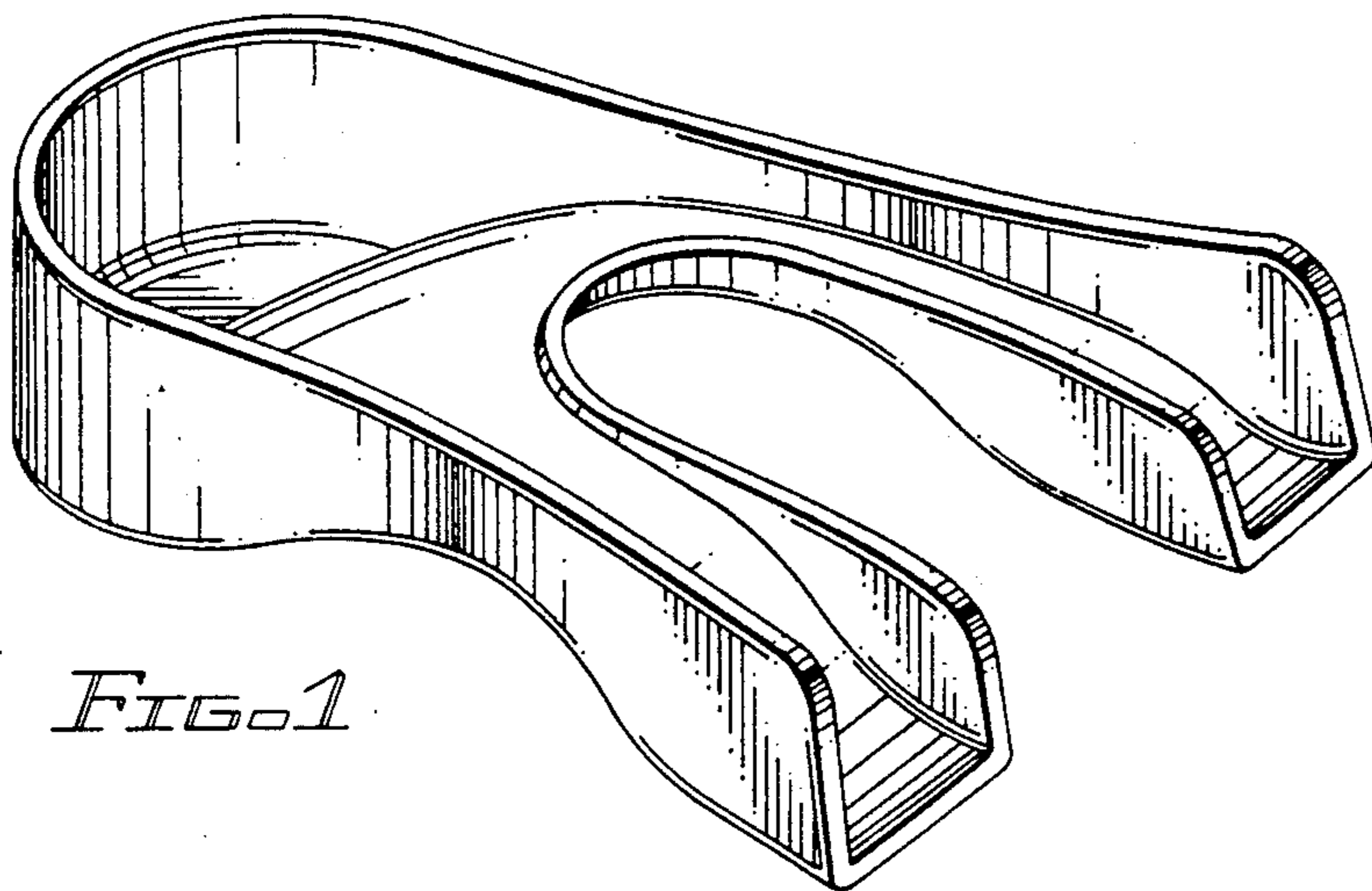

FIG. 1

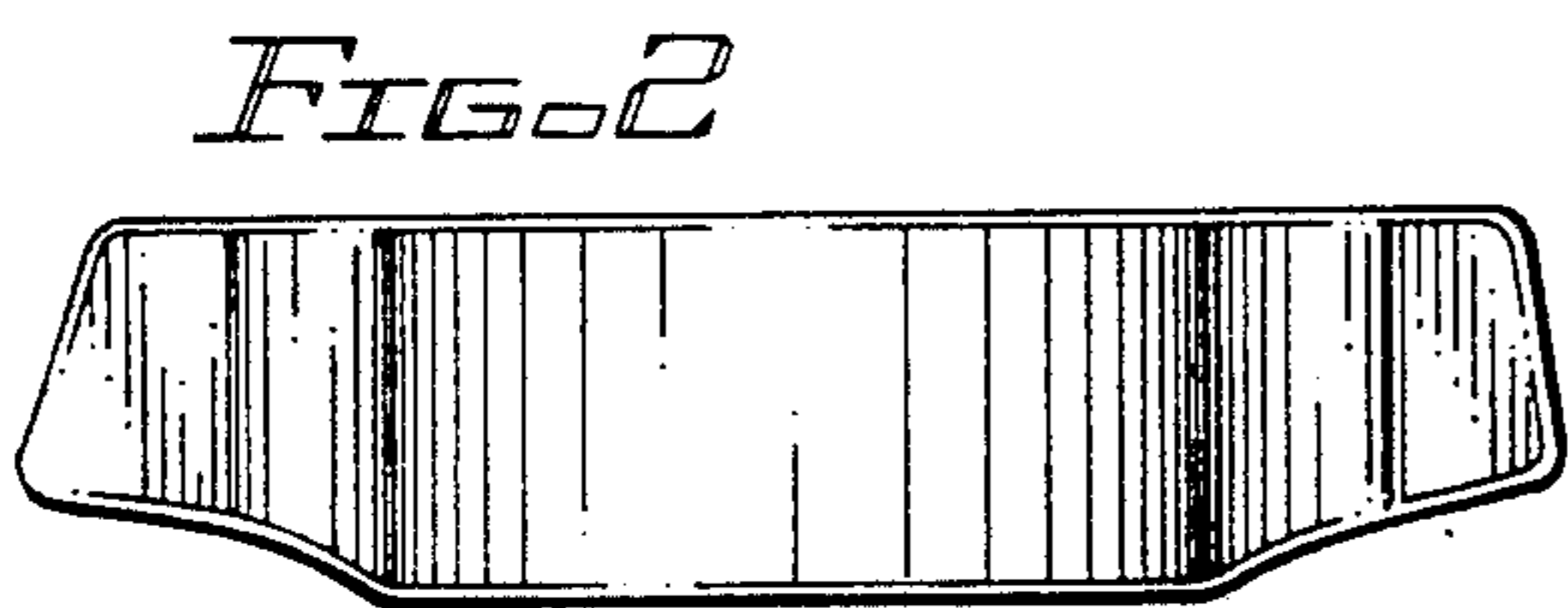

FIG. 2

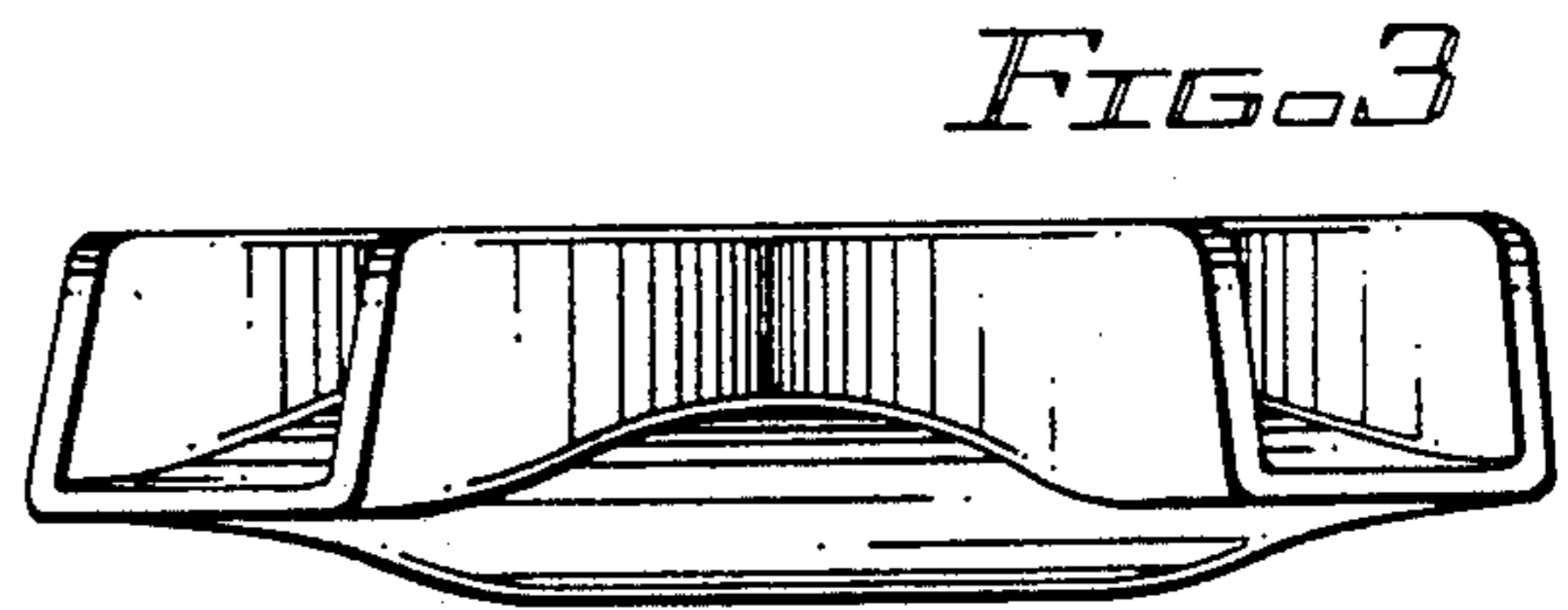

FIG. 3

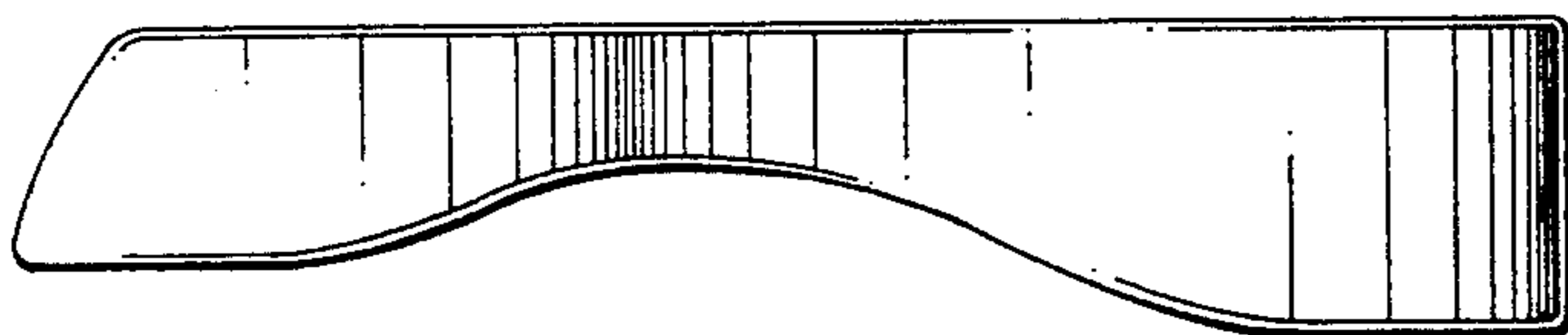

FIG. 4

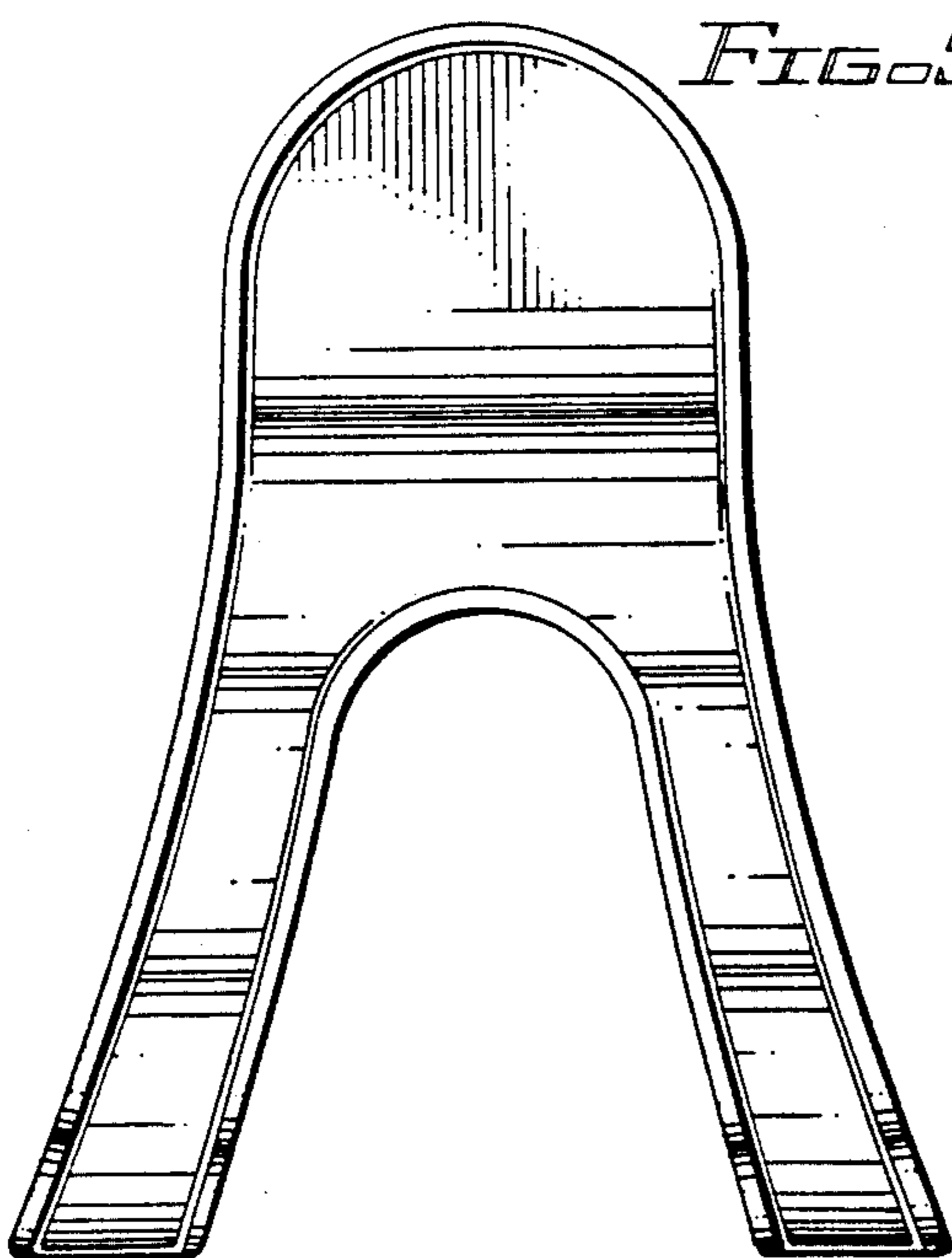

FIG. 5

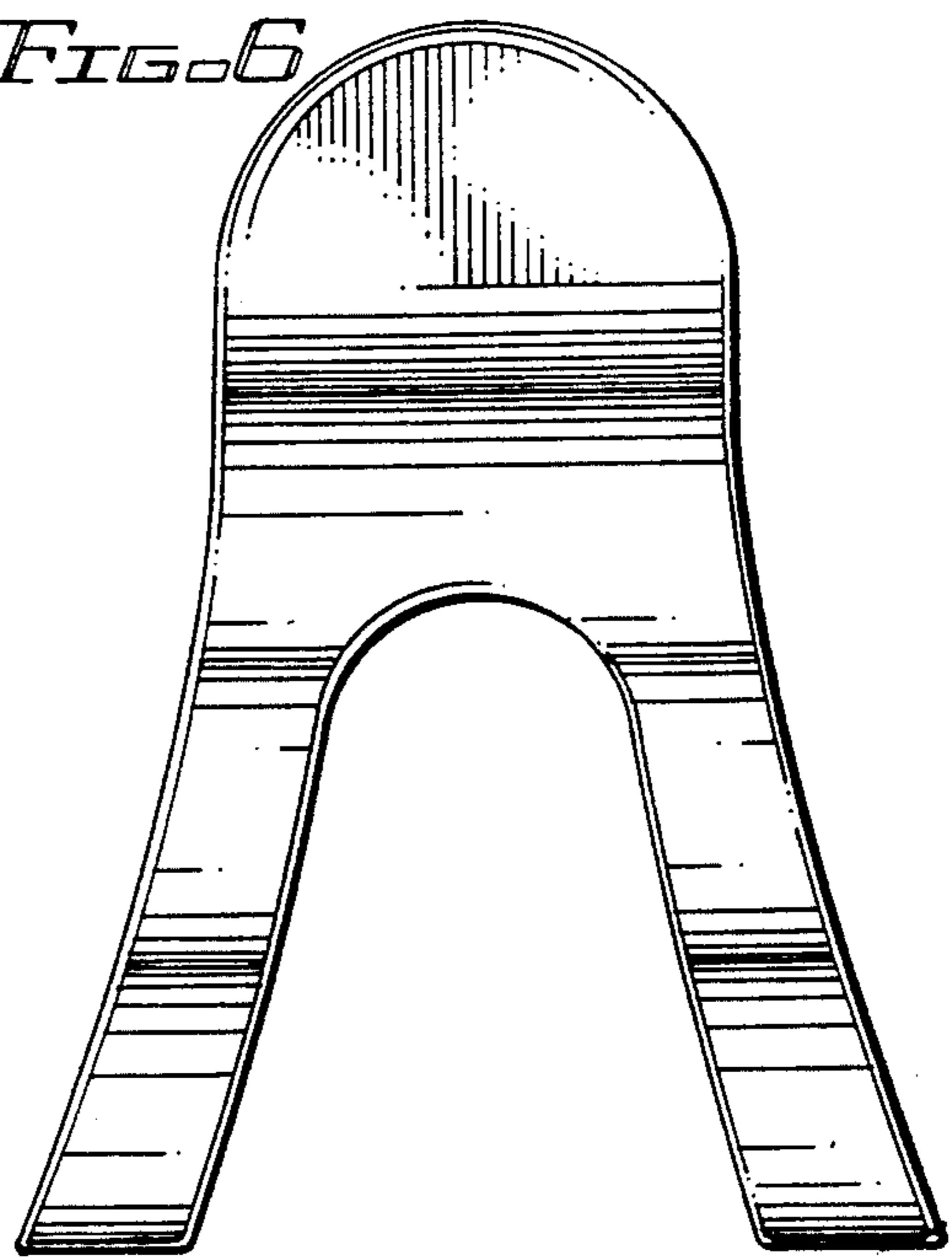

FIG. 6

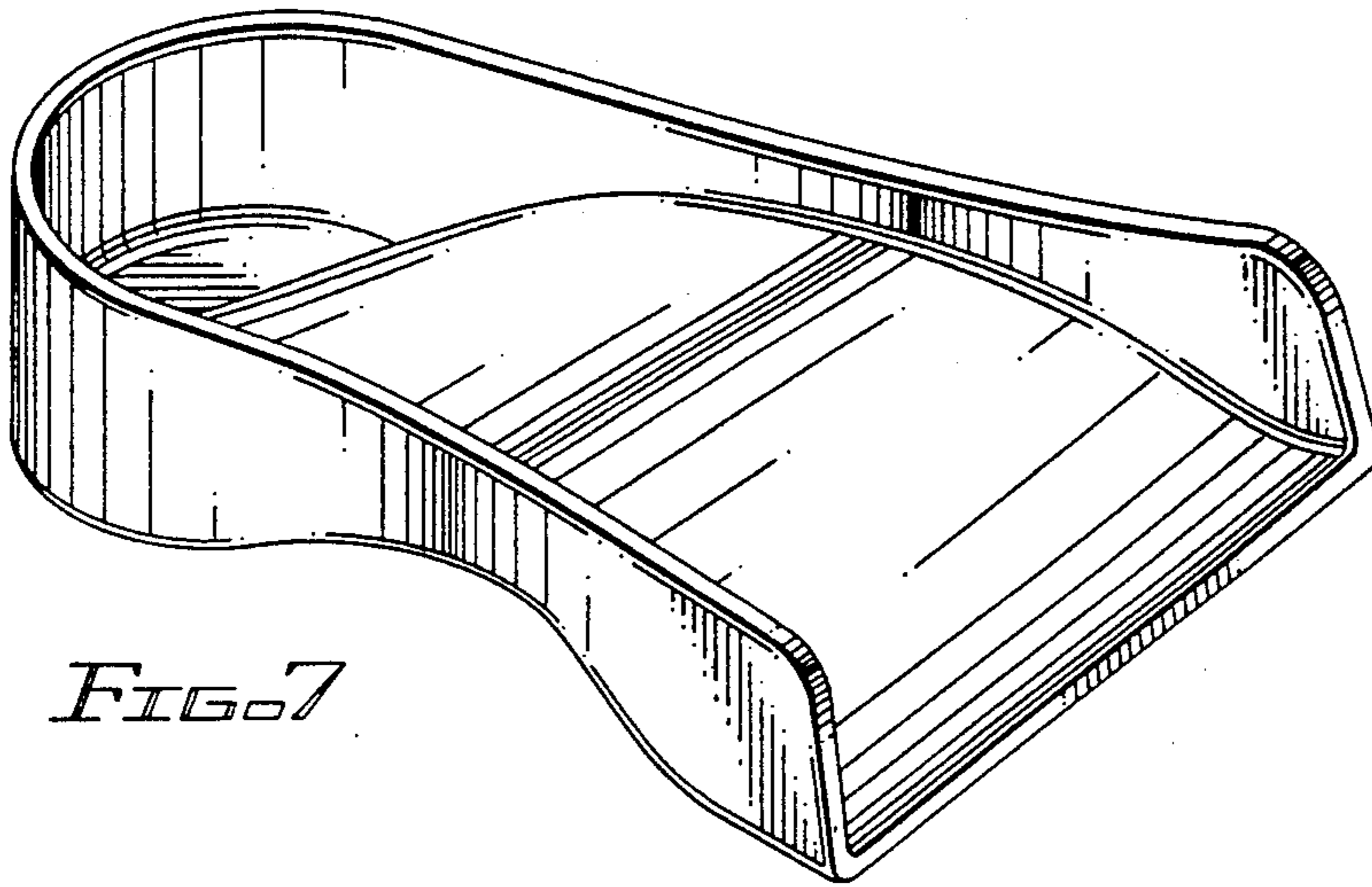

FIG. 7

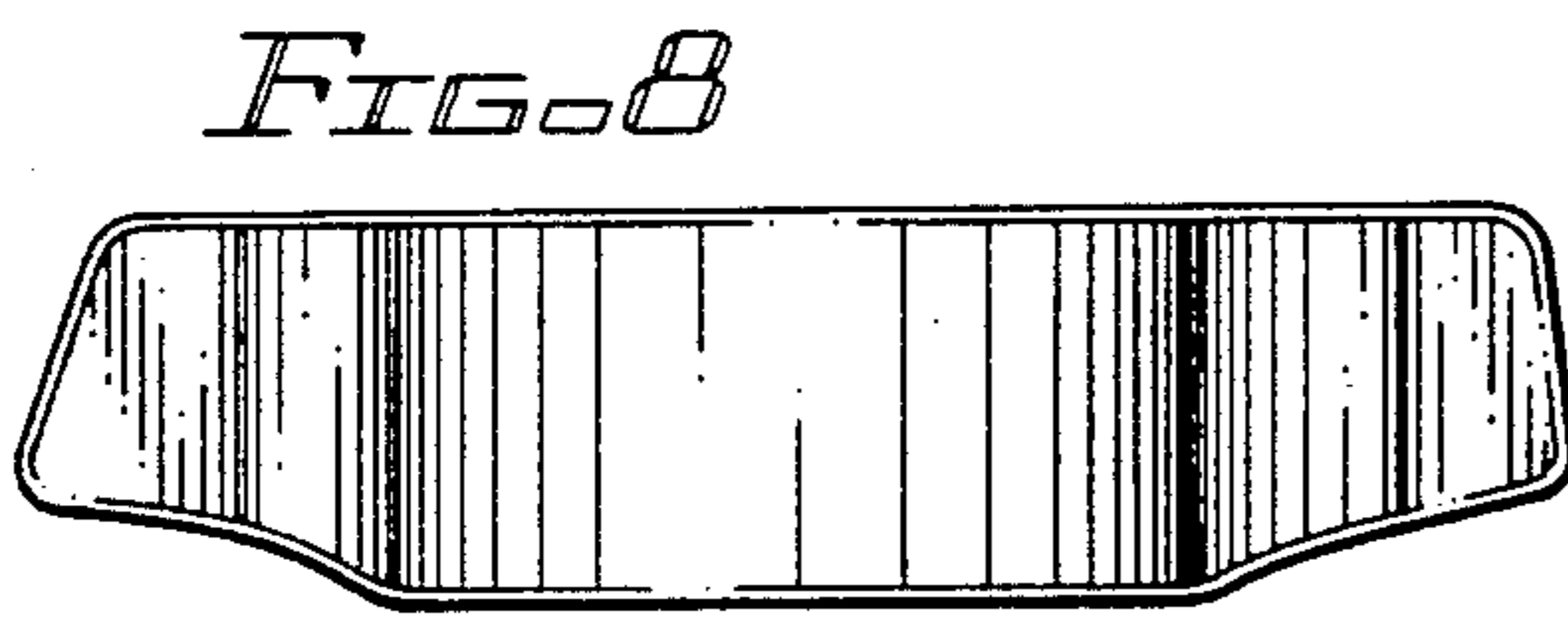

FIG. 8

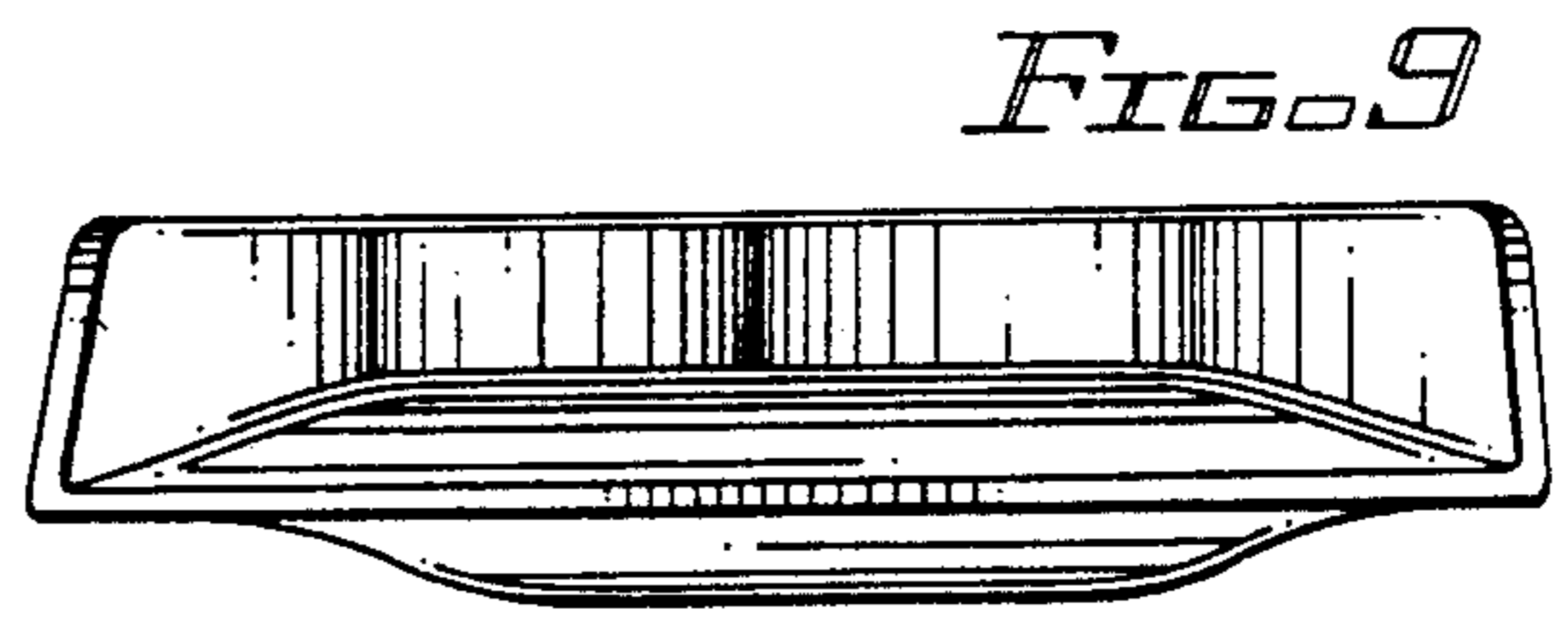

FIG. 9

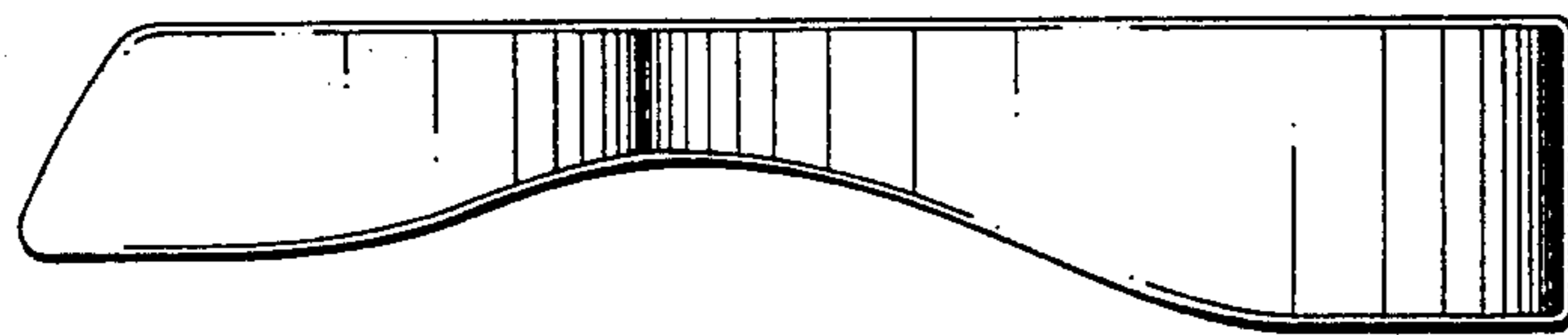

FIG. 10

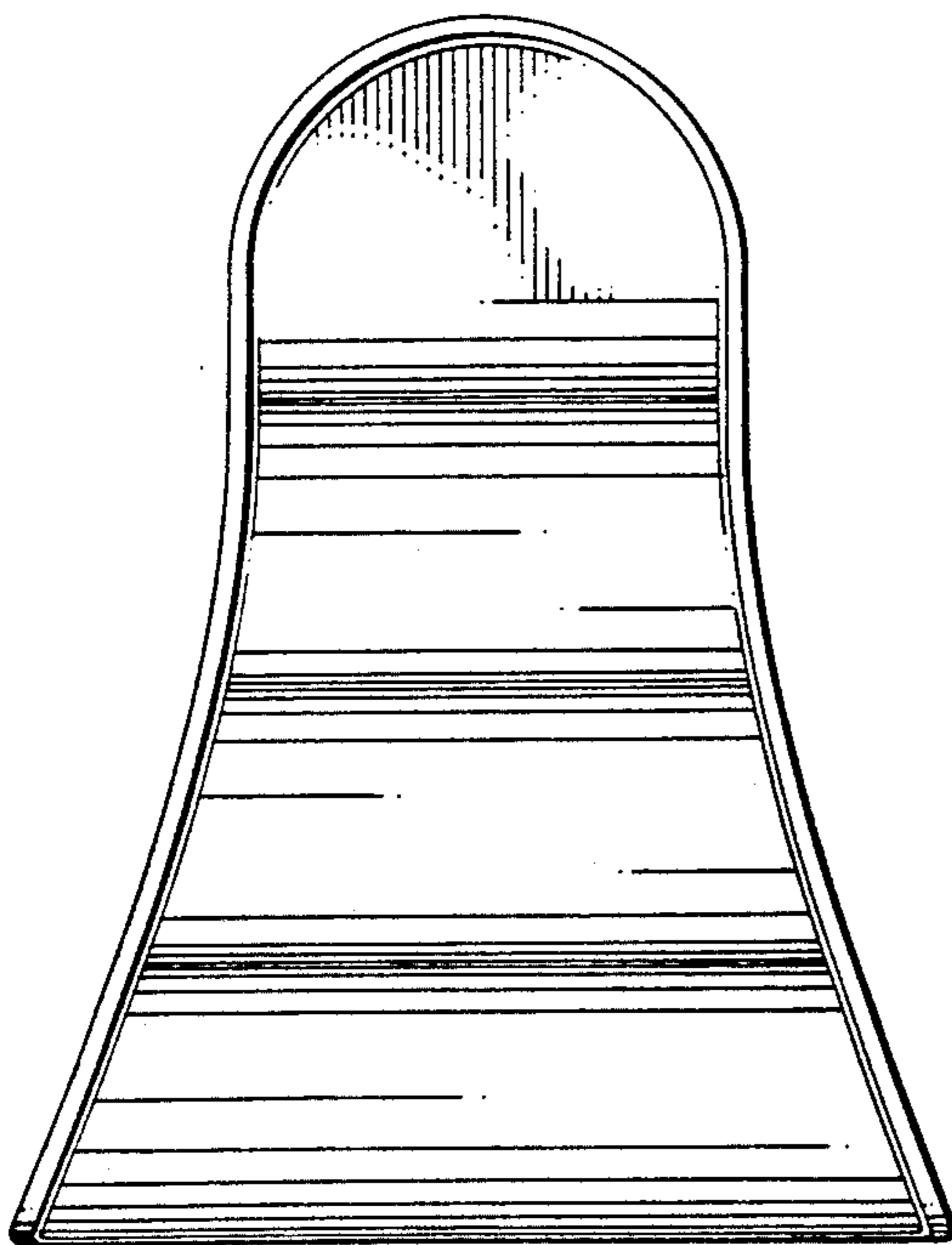

FIG. 11

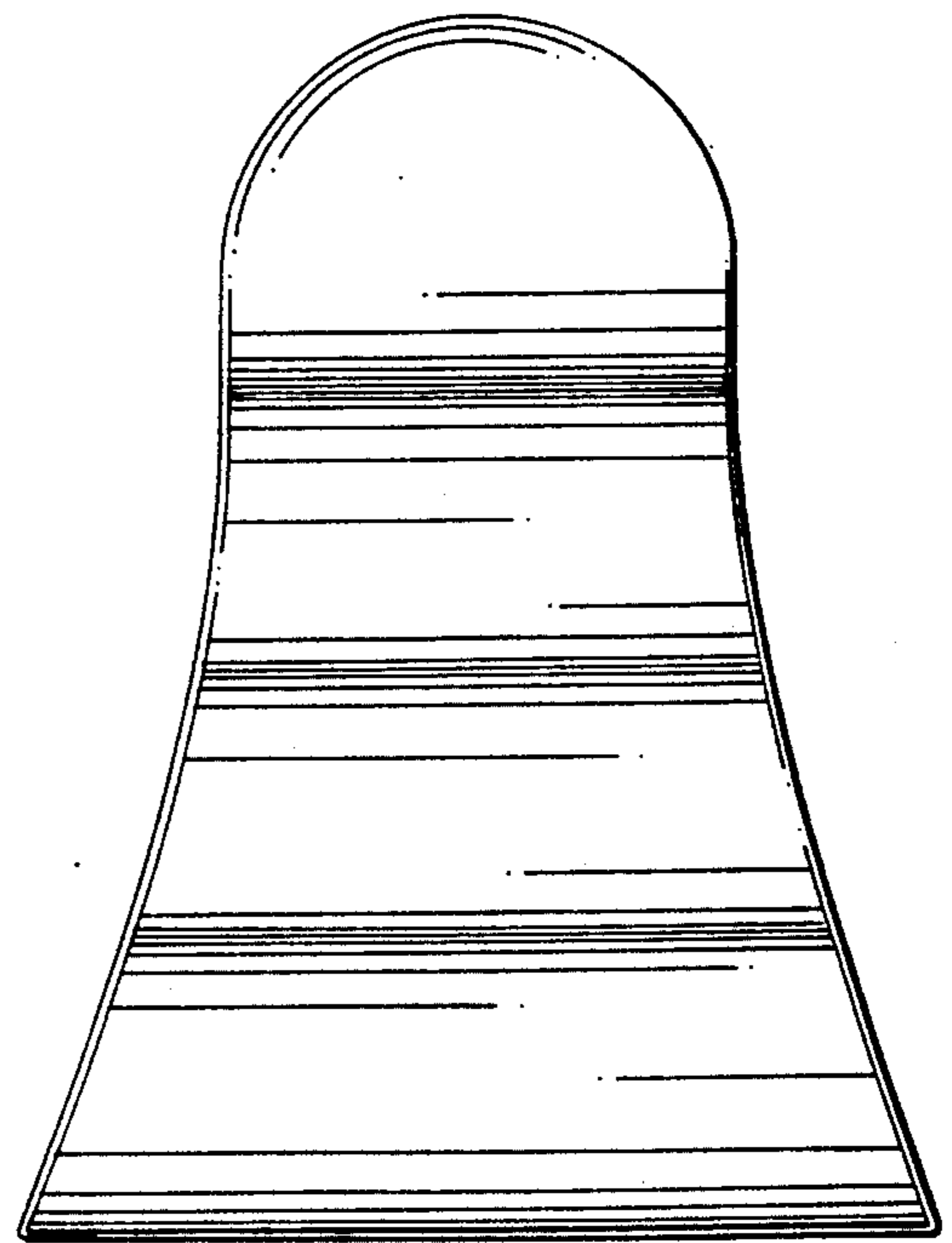

FIG. 12

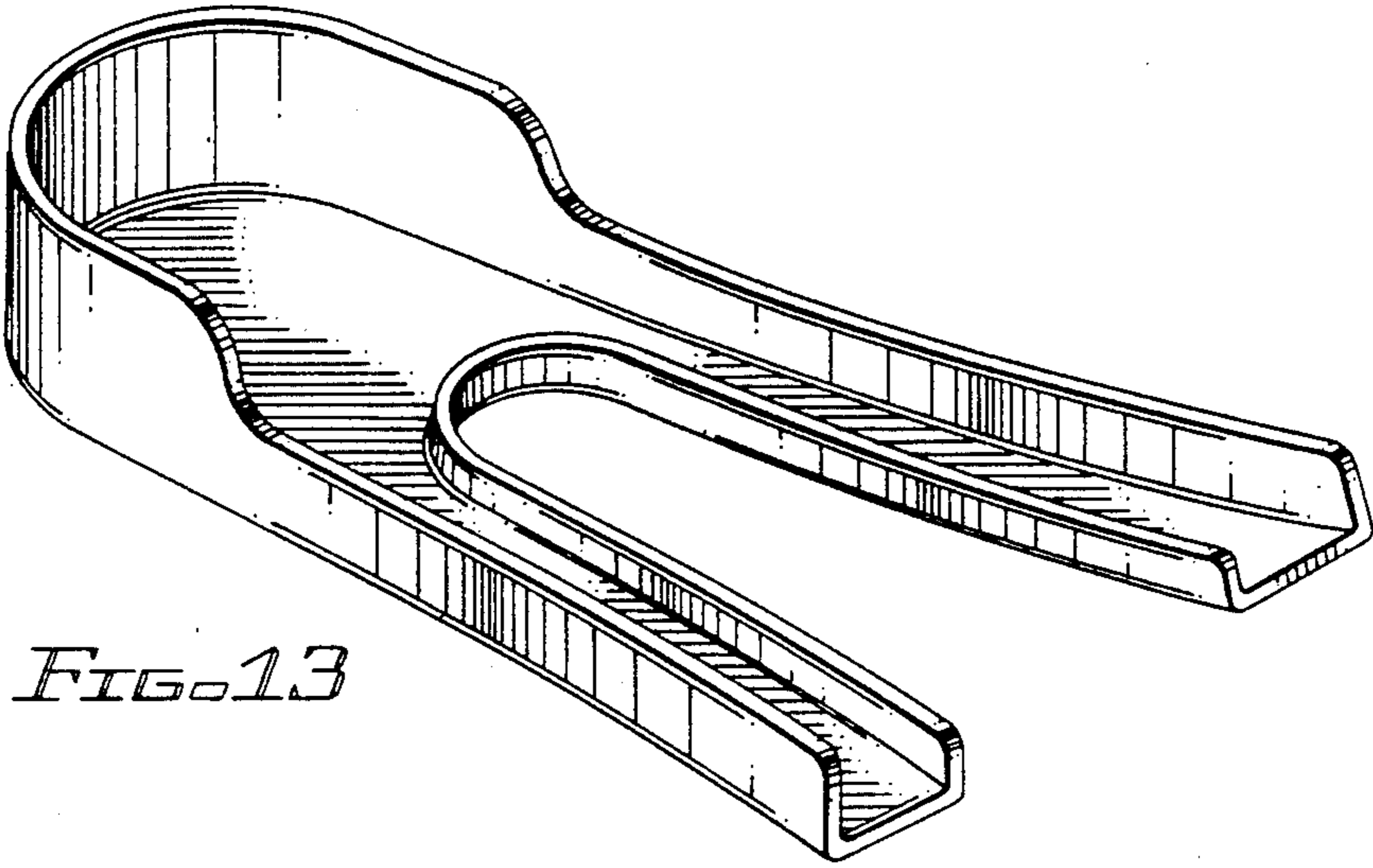

FIG. 13



FIG. 14



FIG. 15

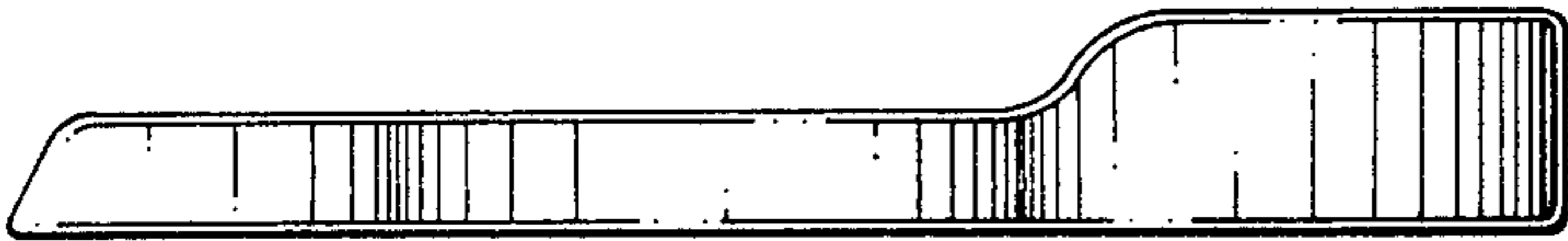

FIG. 16

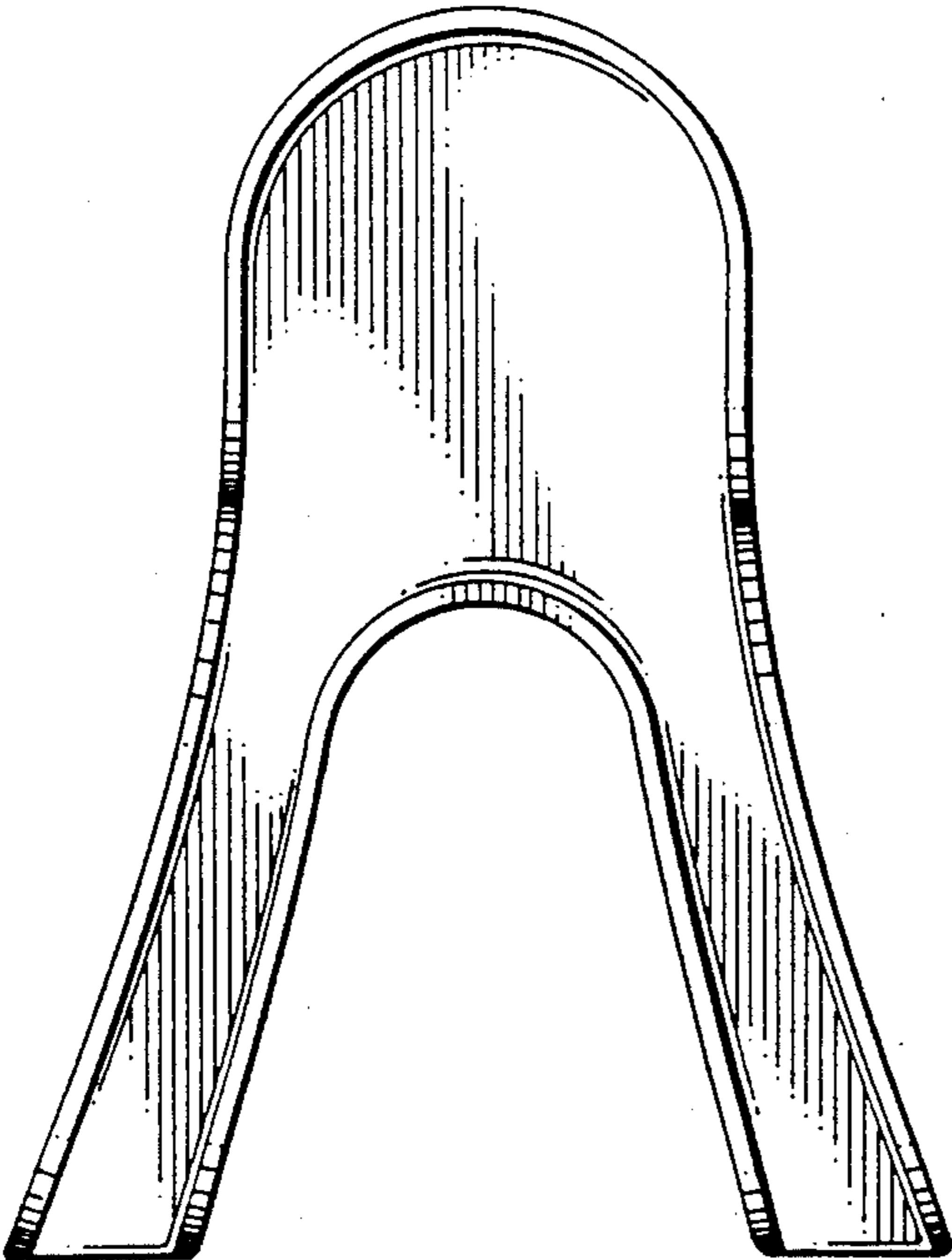

FIG. 17

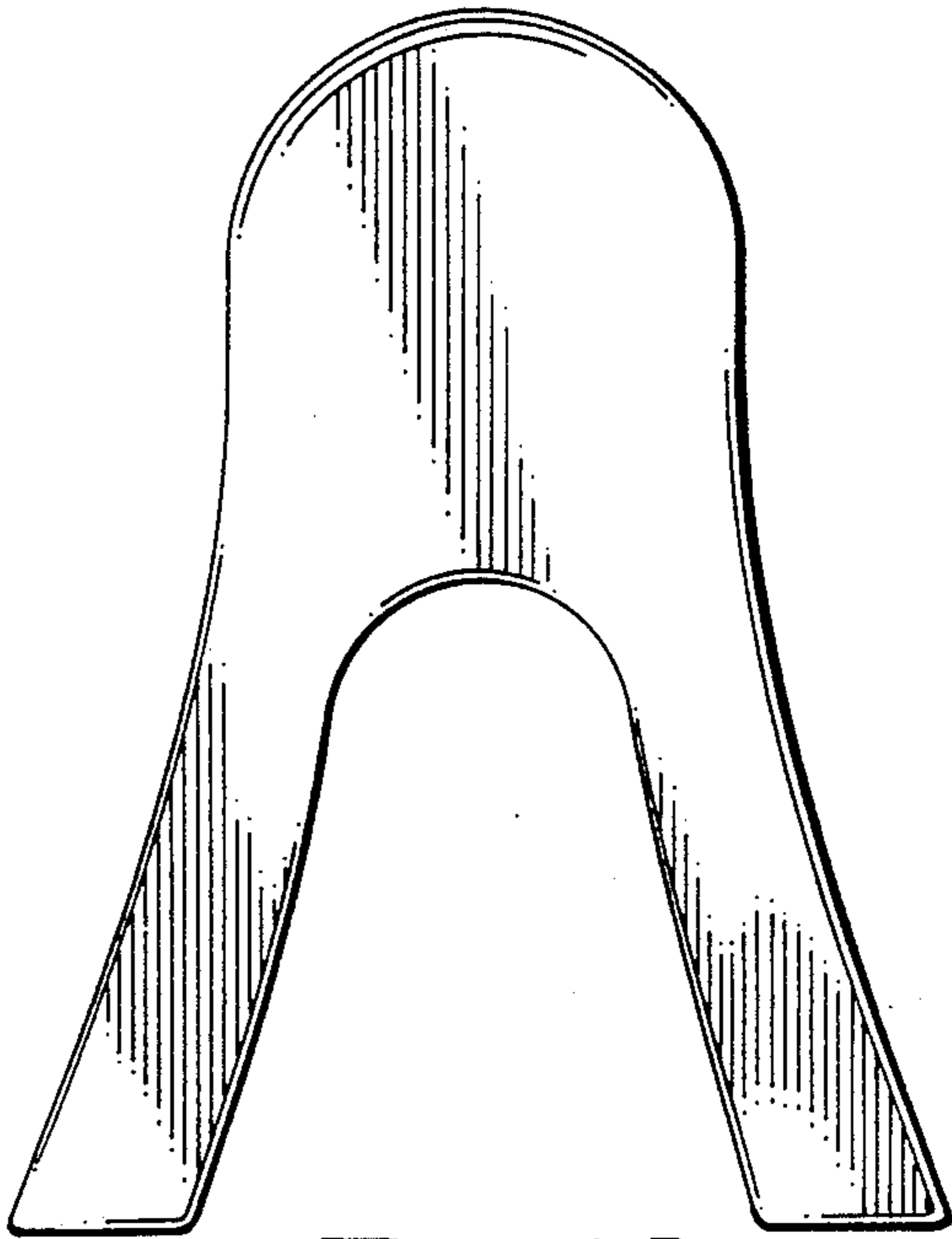

FIG. 18