



US00D323157S

United States Patent [19]

[11] Patent Number: **Des. 323,157**

Mia Je

[45] Date of Patent: **** Jan. 14, 1992**

[54] **LAPTOP PERSONAL COMPUTER**

[75] Inventor: **Patrick N. Mia Je**, Singapore, Singapore

[73] Assignee: **Essex Electric Pte. Ltd.**, Singapore

[**] Term: **14 Years**

[21] Appl. No.: **462,434**

[22] Filed: **Jan. 9, 1990**

[30] **Foreign Application Priority Data**

Nov. 6, 1989 [GB] United Kingdom 2002208

[52] U.S. Cl. **D14/106**

[58] Field of Search D14/100, 101, 106, 115;
D18/1, 7, 11, 12; 340/700, 706, 711; 341/22, 23;
235/145 A, 145 R; 358/249, 254; 364/706-710;
400/477, 485, 486, 488, 489, 681, 682, 691;
312/208; 248/917-925

[56] **References Cited**

U.S. PATENT DOCUMENTS

- D. 291,442 8/1987 Kurihara D14/106
- D. 293,678 1/1988 Sawatani et al. D14/106
- D. 294,831 3/1988 Hara et al. D14/106

- D. 298,945 12/1988 Kagayama et al. D14/106
- D. 308,194 5/1990 Messerschmidt et al. D14/106
- D. 309,895 8/1990 Lampe D14/106
- D. 311,528 10/1990 Sugano et al. D14/106

Primary Examiner—Wallace R. Burke
Assistant Examiner—Freda S. Nunn
Attorney, Agent, or Firm—Finnegan, Henderson, Farabow, Garrett & Dunner

[57] **CLAIM**

The ornamental design for a laptop personal computer, as shown and described.

DESCRIPTION

FIG. 1 is a front left side perspective view of a laptop personal computer showing my new design with the display screen shown in an opened position; FIG. 2 is a rear left side perspective view thereof; FIG. 3 is a bottom plan view thereof; FIG. 4 is a top plan view thereof showing the carrying handle extended; FIG. 5 is a rear elevational view thereof; and FIG. 6 is a right side elevational view thereof. The display screen is shown in a closed position in FIGS. 2-6.

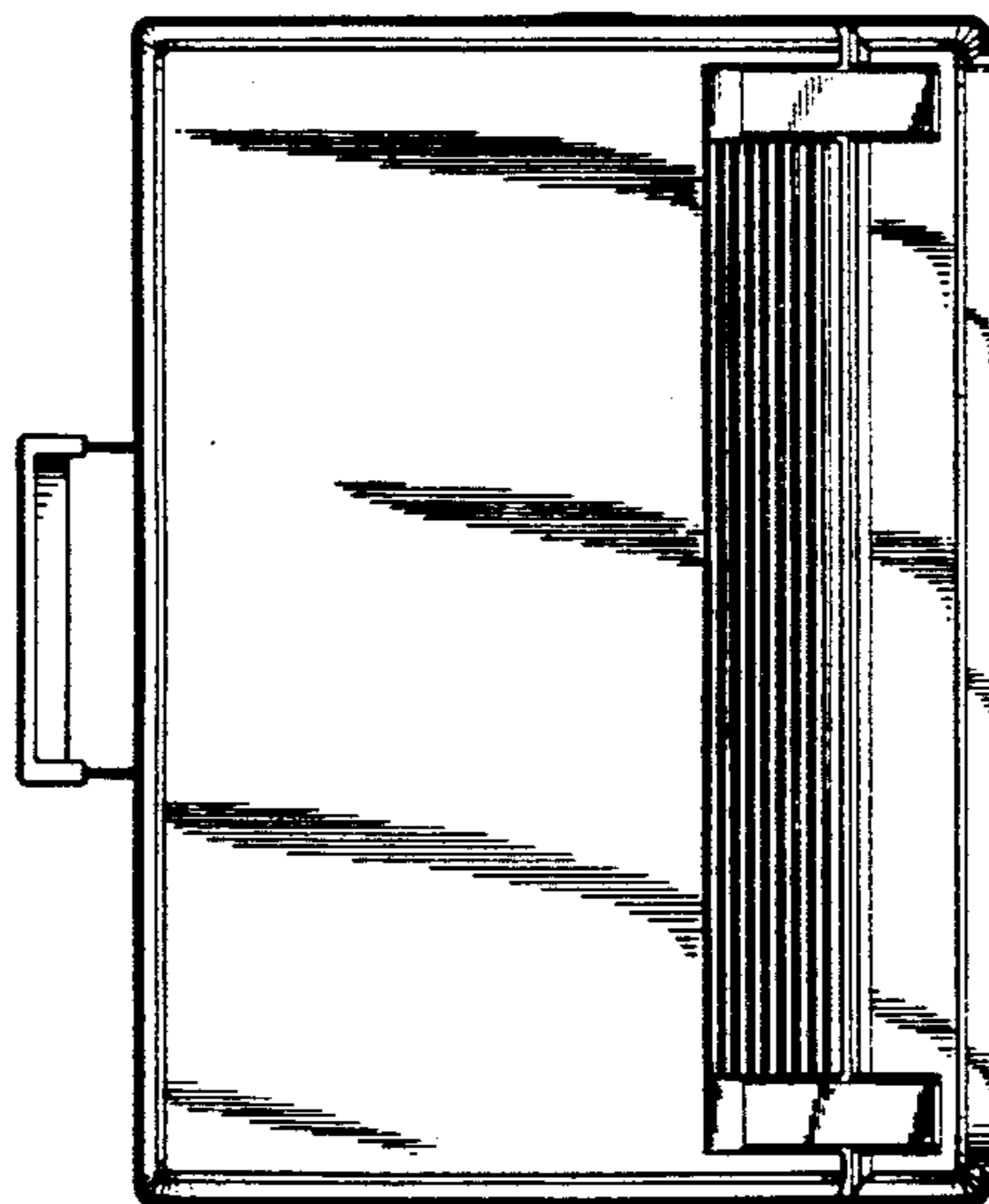
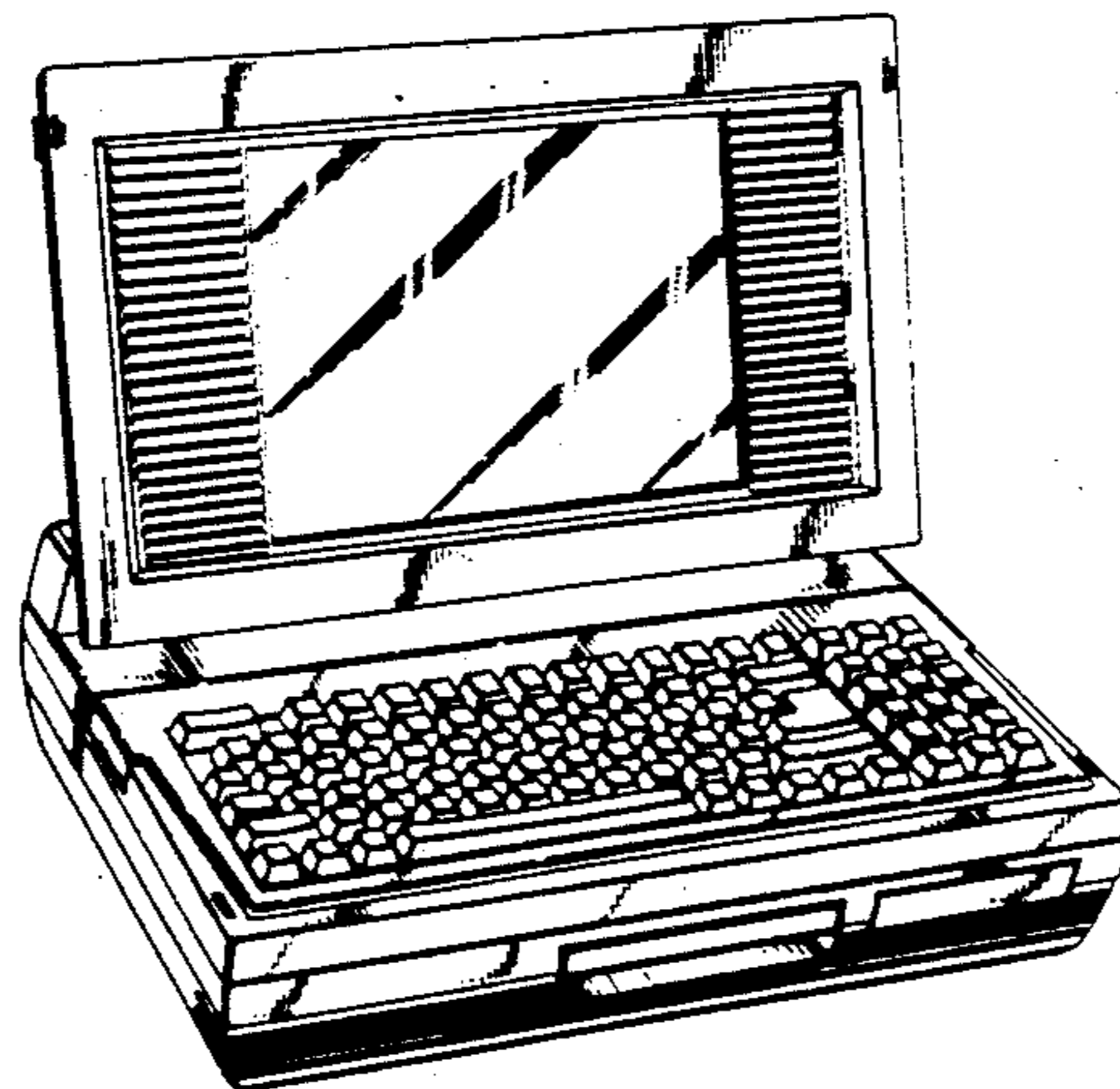

Fig. 1.

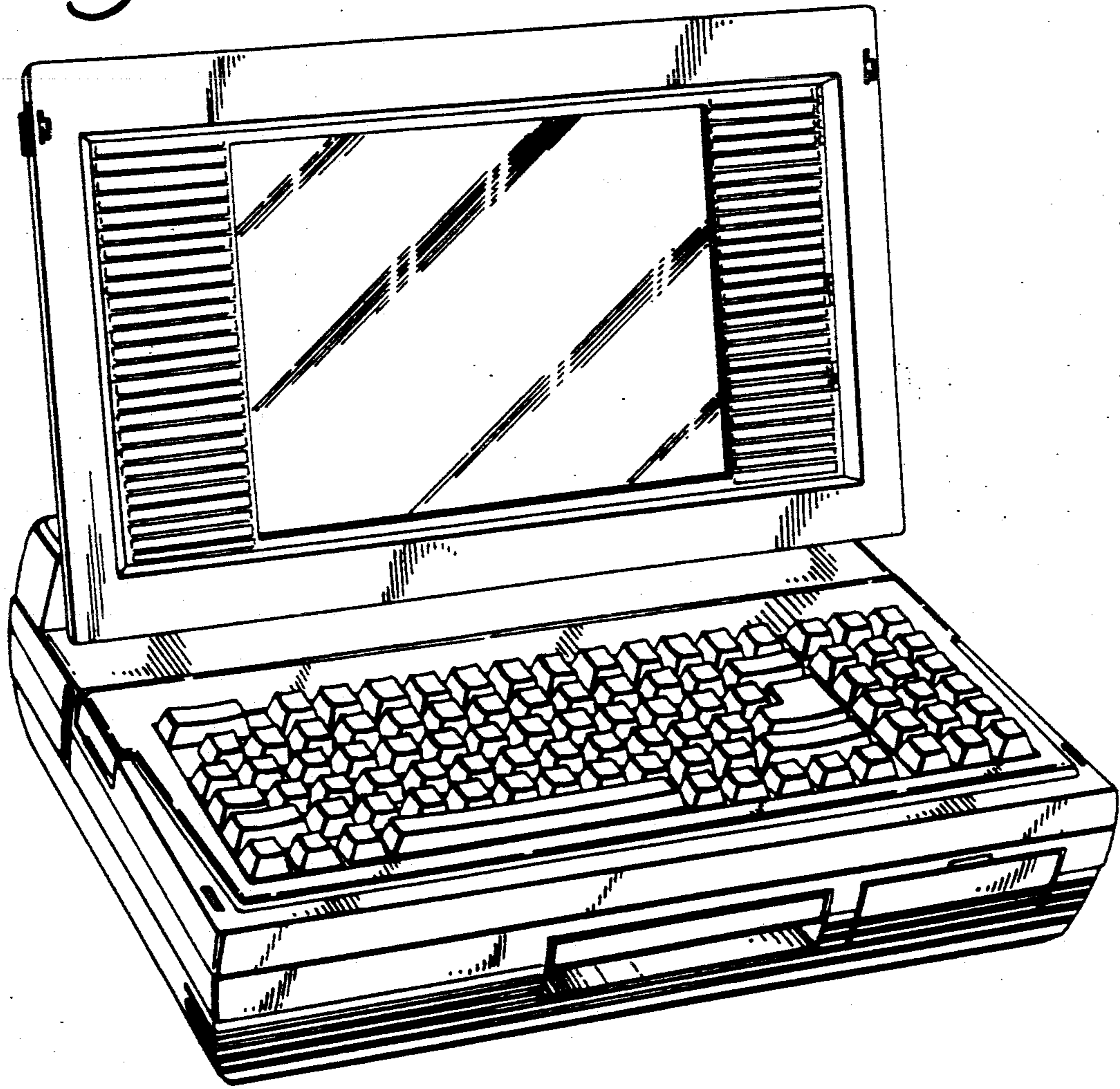

Fig. 2.

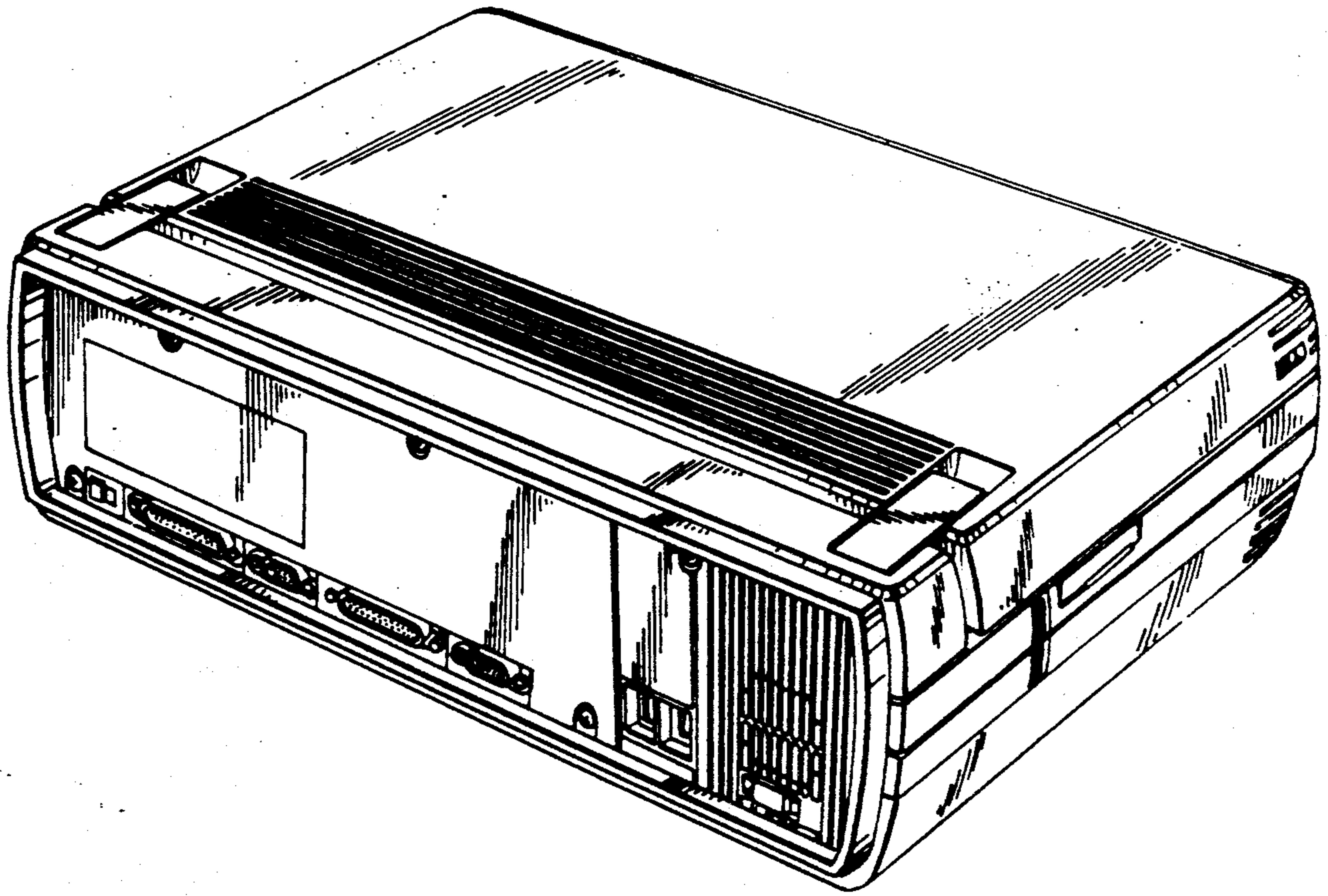

Fig. 3.

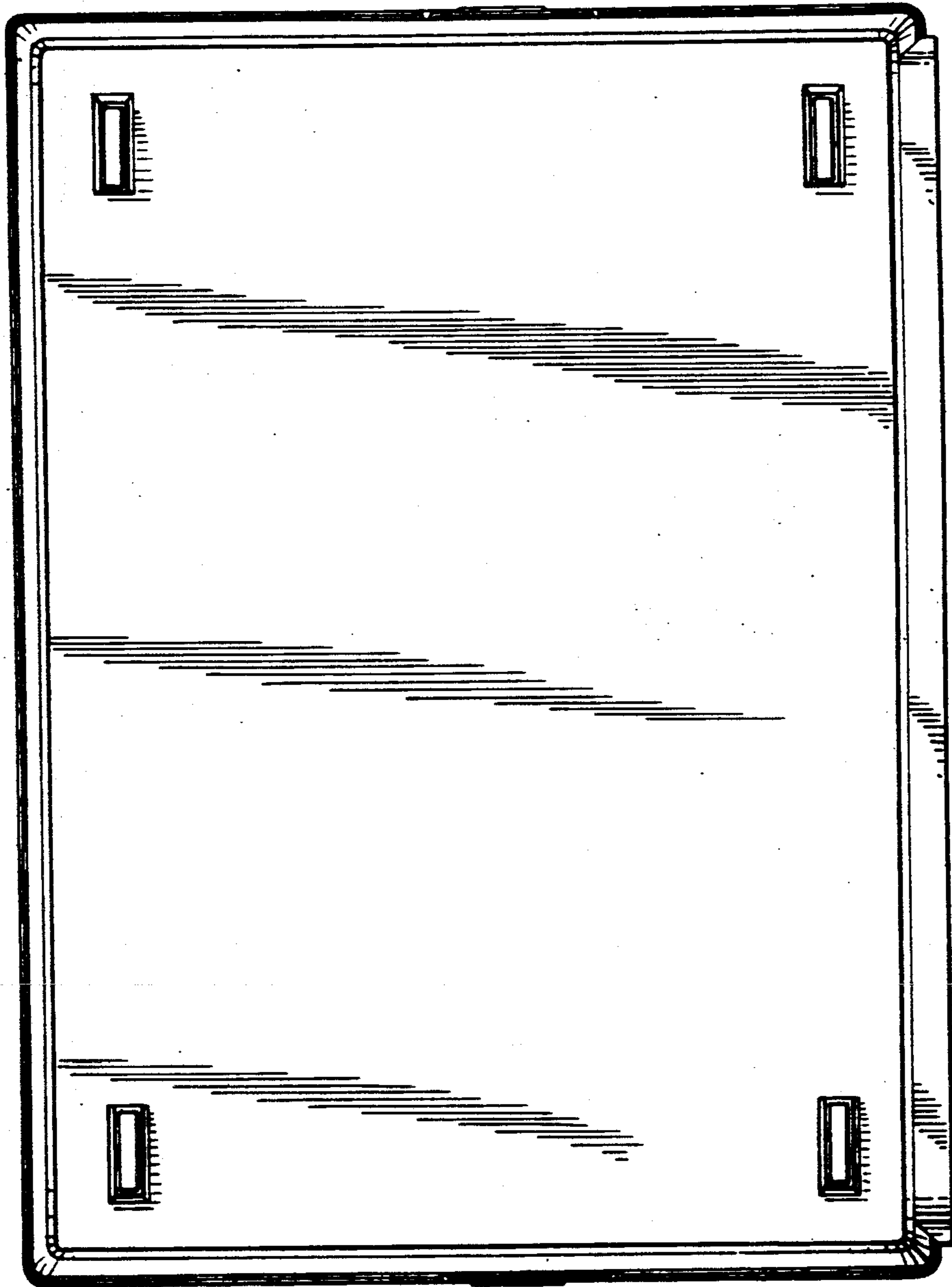

Fig. 4.

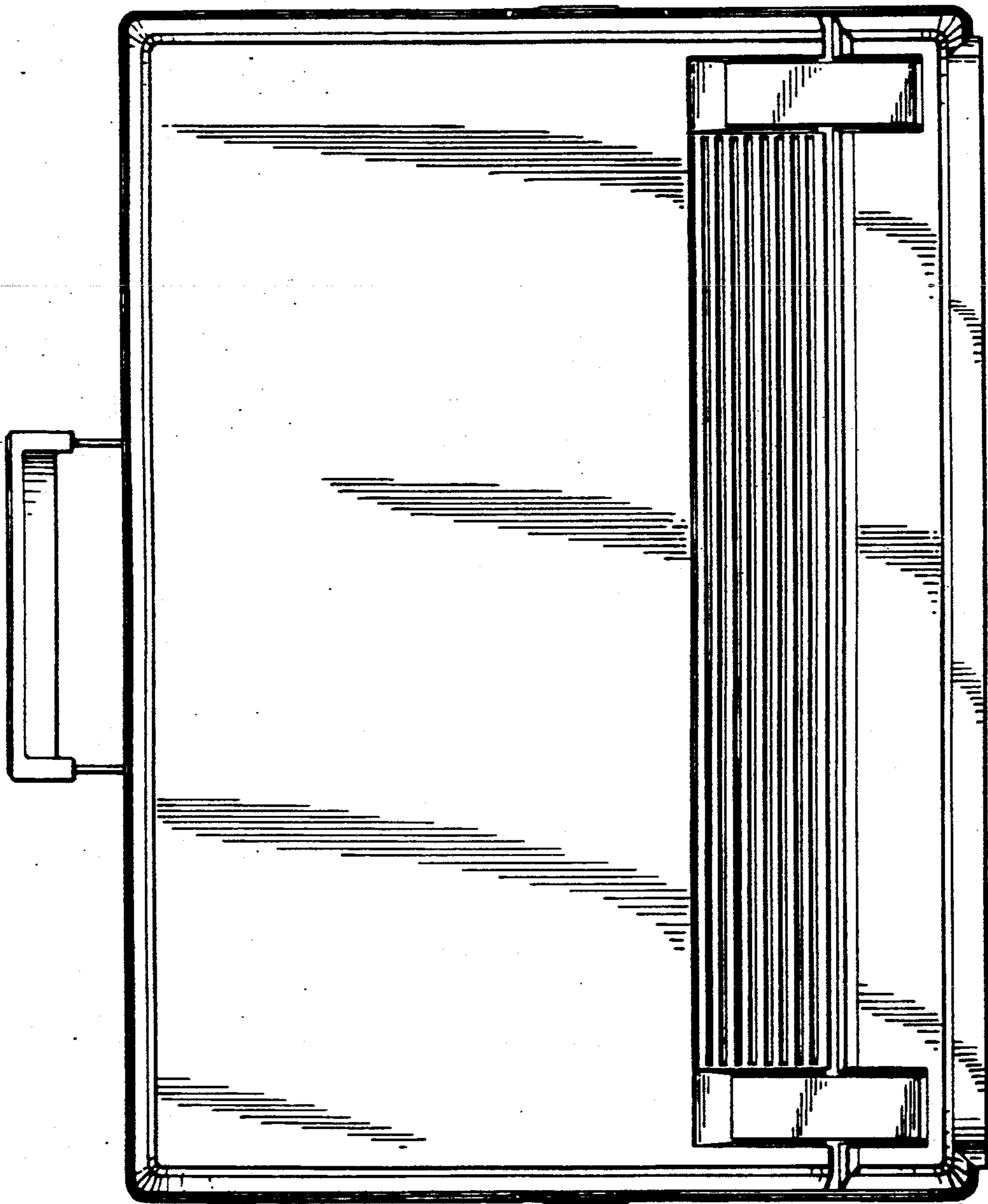

Fig. 5.

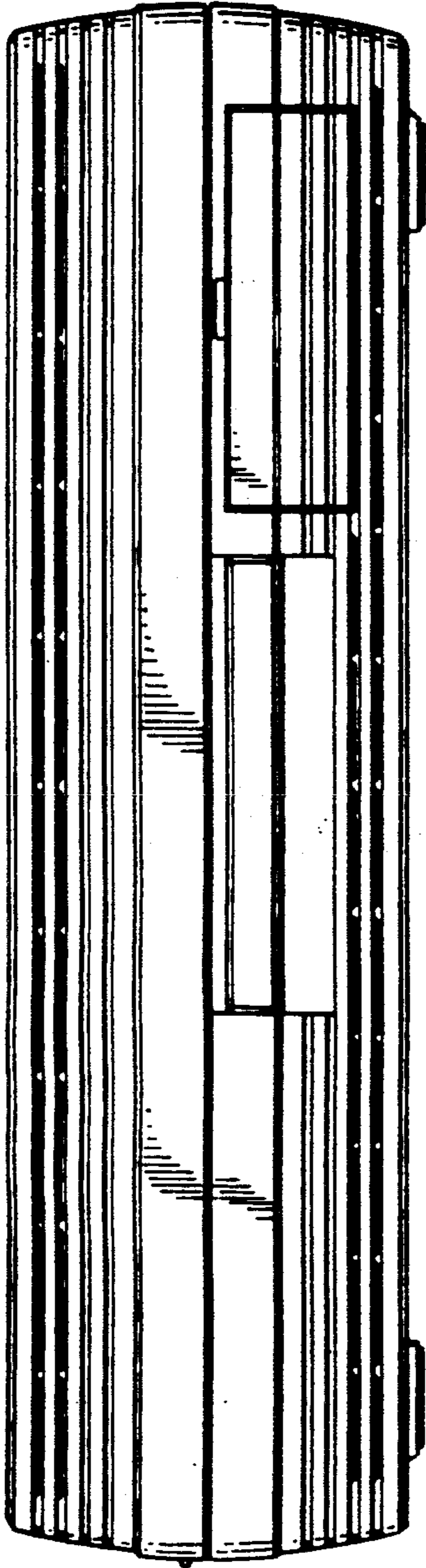

Fig. 6.

