



US00D323093S

United States Patent [19]

Picozza et al.

[11] Patent Number: Des. 323,093

[45] Date of Patent: ** Jan. 14, 1992

[54] PITCHER OR THE LIKE

[75] Inventors: Augusto A. Picozza, Orlando, Fla.;
Rino Conti, Stoughton, Mass.

[73] Assignee: Dart Industries Inc., Deerfield, Ill.

[*] Notice: The portion of the term of this patent
subsequent to Aug. 27, 2005 has been
disclaimed.

[**] Term: 14 Years

[21] Appl. No.: 291,073

[22] Filed: Dec. 28, 1988

[52] U.S. Cl. D7/319

[58] Field of Search D7/316-319,
D7/300, 302, 303, 320-322, 312

[56] References Cited

U.S. PATENT DOCUMENTS

D. 43,854	4/1913	Sanford	D7/319
D. 97,920	12/1935	Cowan	D7/321
D. 97,924	12/1935	Cowan	D7/319
D. 167,259	7/1952	Fox	D7/317
D. 229,657	12/1973	Cyren	D7/317
D. 243,579	3/1977	Benes	D7/319
D. 248,205	6/1978	Schreckengost	D7/319
D. 264,926	6/1982	McClelland	D7/317
D. 268,726	4/1983	Trombly	D7/317
D. 270,602	9/1983	Fritz	D7/319
D. 285,637	9/1986	Zieff	D7/536
D. 285,767	9/1986	Zieff	D7/603
D. 291,270	8/1987	Tardiff	D7/317
D. 296,973	8/1988	Pozzi	D7/319 X

FOREIGN PATENT DOCUMENTS

1047931 11/1966 United Kingdom D7/317 X

OTHER PUBLICATIONS

The Tupperware Collection, vol. 1, No. 1, Summer, 1986,
p. 8, #222/top-right Clear Pitcher, #213/top corner
Opaque Pitcher.

Bloomington's Living Quarters, catalog, date 4-14-84,
p. 17, bottom right, item Z-Faceted Clear Pitcher/-
Crown Corning.

Tableware International, Jul. 1985, p. 30, bottom
panel-FUU HWA Vacuum Bottle Co., Ltd.-Ribbed
Jugs in center.

Primary Examiner—Winifred E. Herrmann
Attorney, Agent, or Firm—John A. Doninger

[57] CLAIM

The ornamental design for a pitcher or the like, as
shown and described.

DESCRIPTION

FIG. 1 is a top perspective view of the pitcher or the
like showing our new design;
FIG. 2 is a side elevational view thereof;
FIG. 3 is a top plan view thereof;
FIG. 4 is front elevational view thereof;
FIG. 5 is a rear elevational view thereof;
FIG. 6 is a bottom plan view thereof; and
FIG. 7 is a cross-sectional view thereof on an enlarged
scale taken along line 7-7 of FIG. 3 with the fluting
that would be visible through the wall portion omitted
for clarity of illustration.

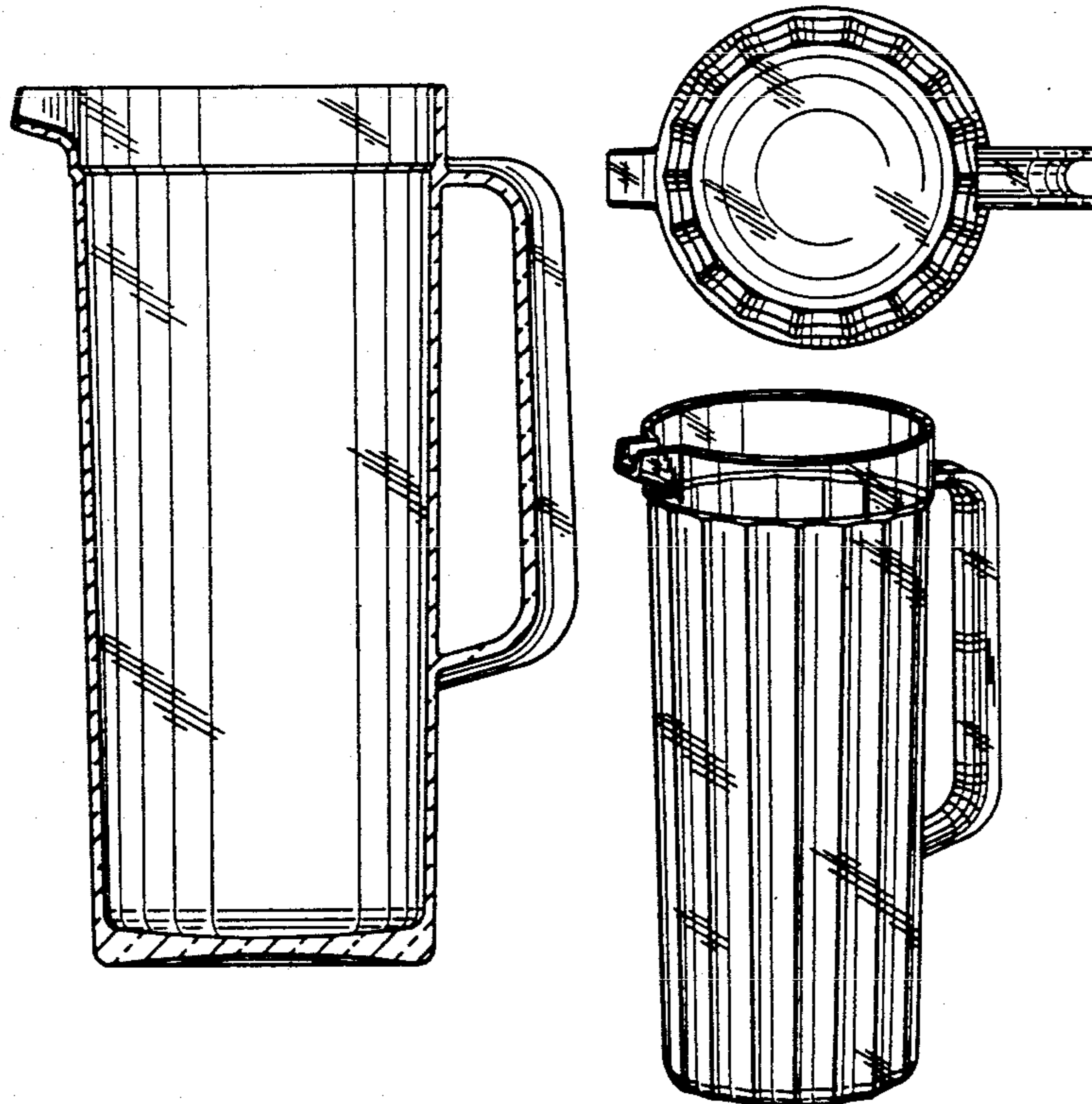

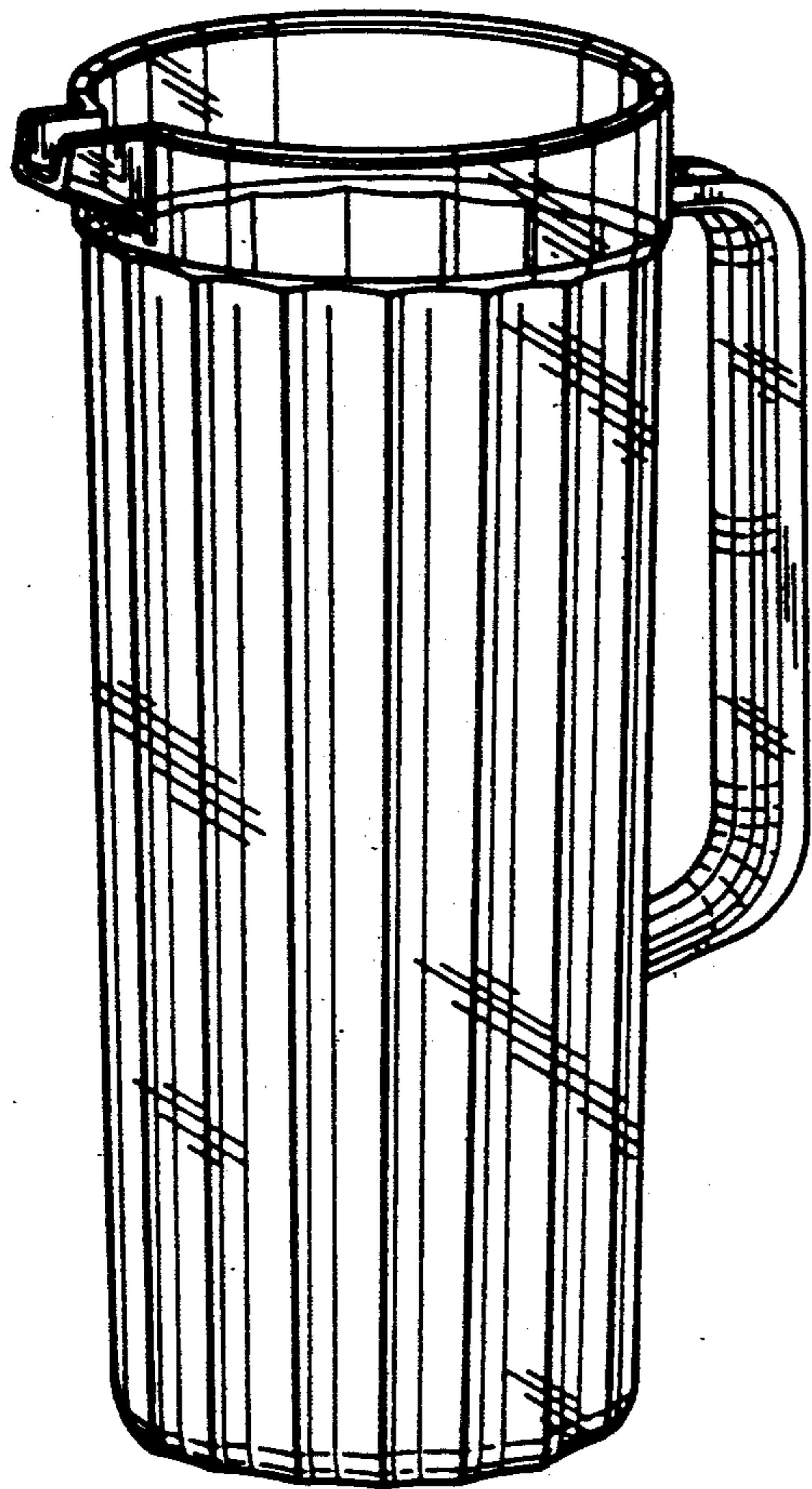

FIG. 1

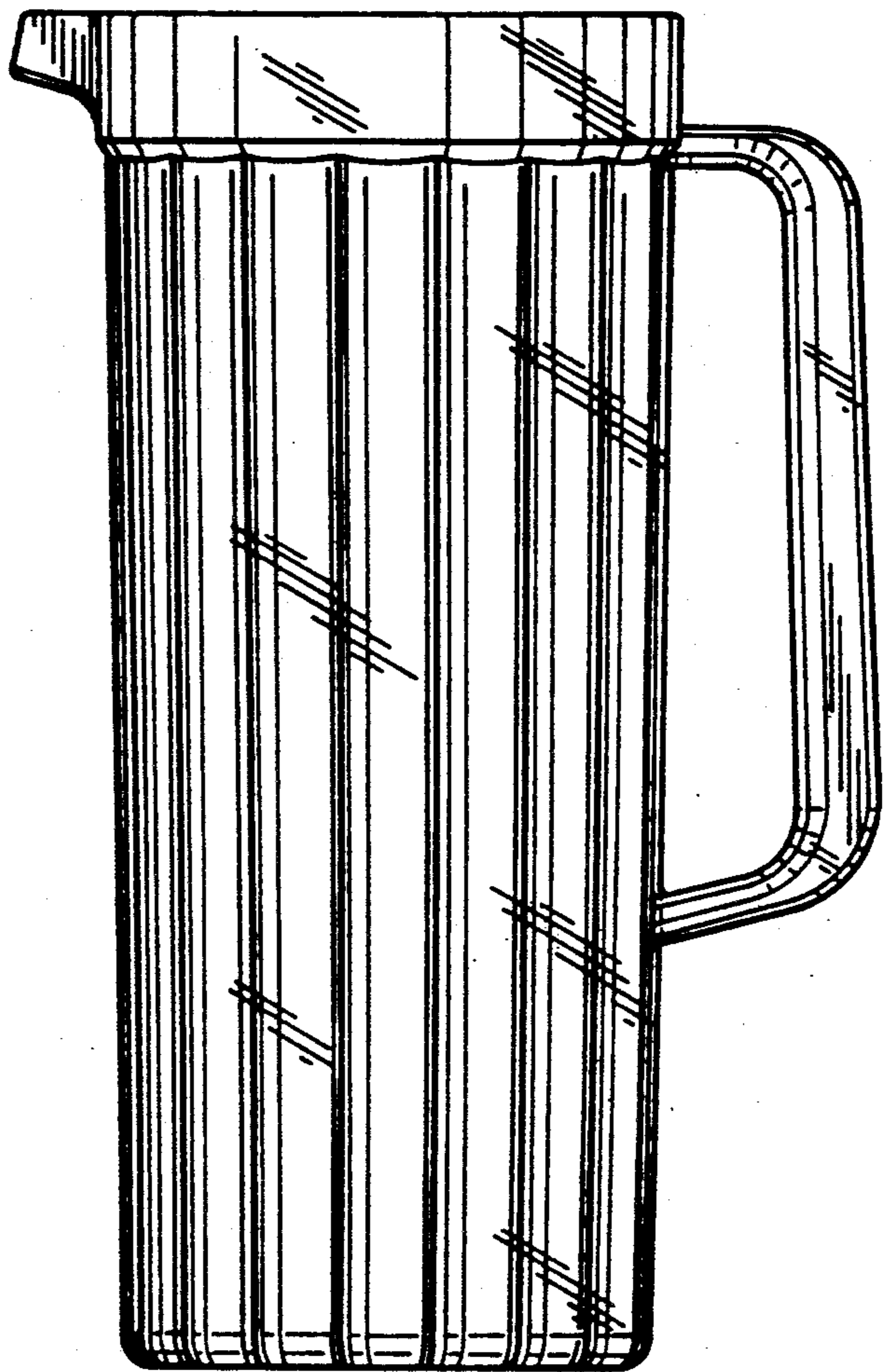

FIG. 2

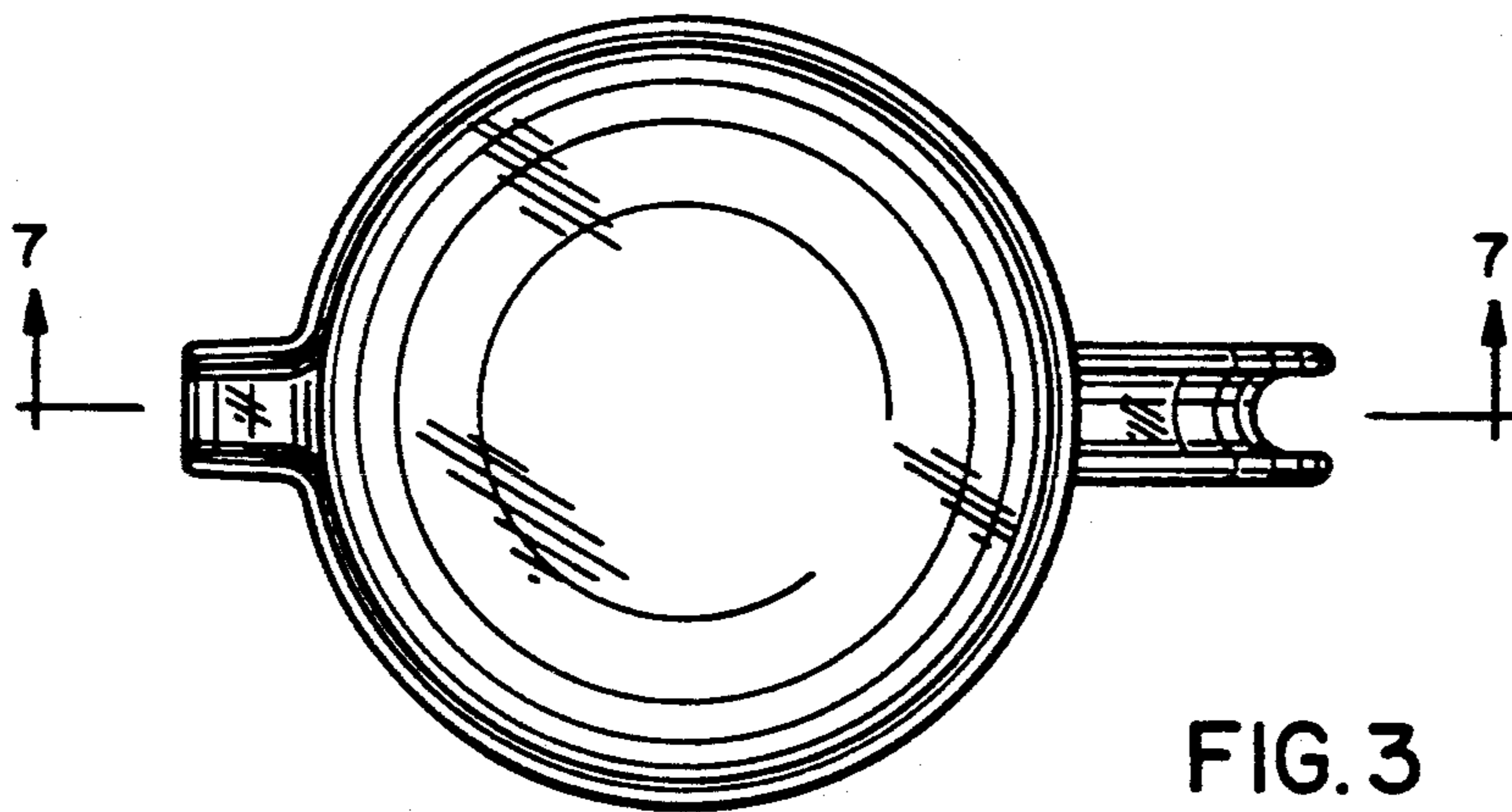

FIG. 3

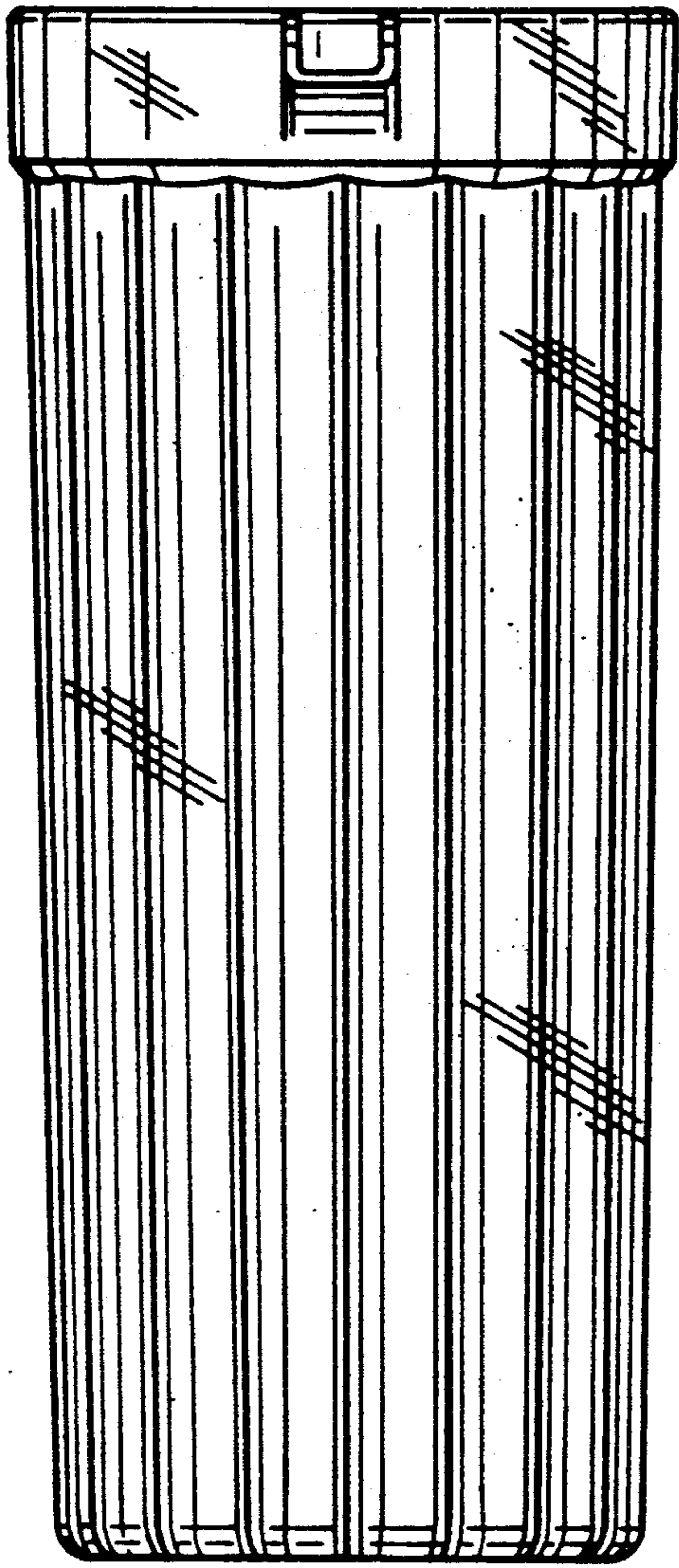

FIG. 4

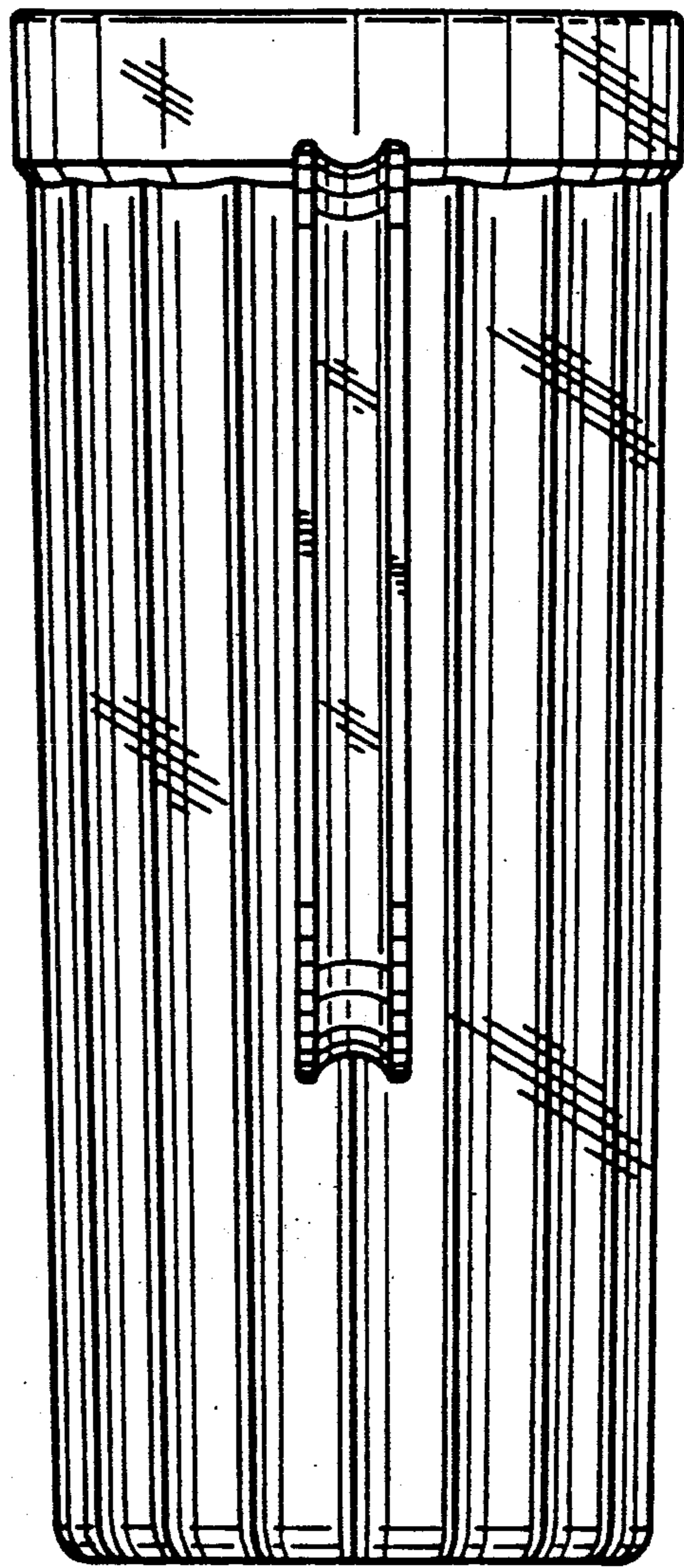

FIG. 5

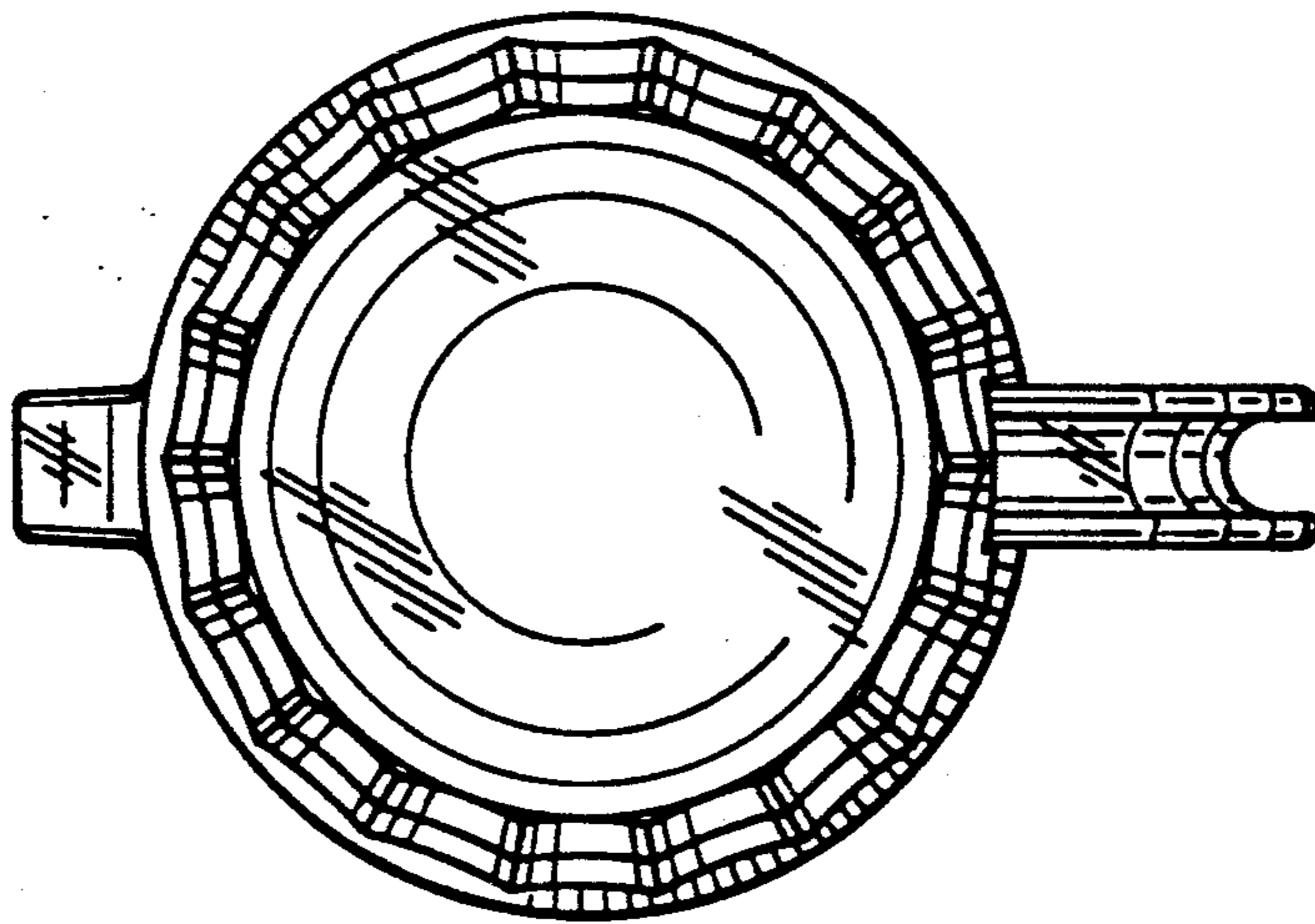

FIG. 6

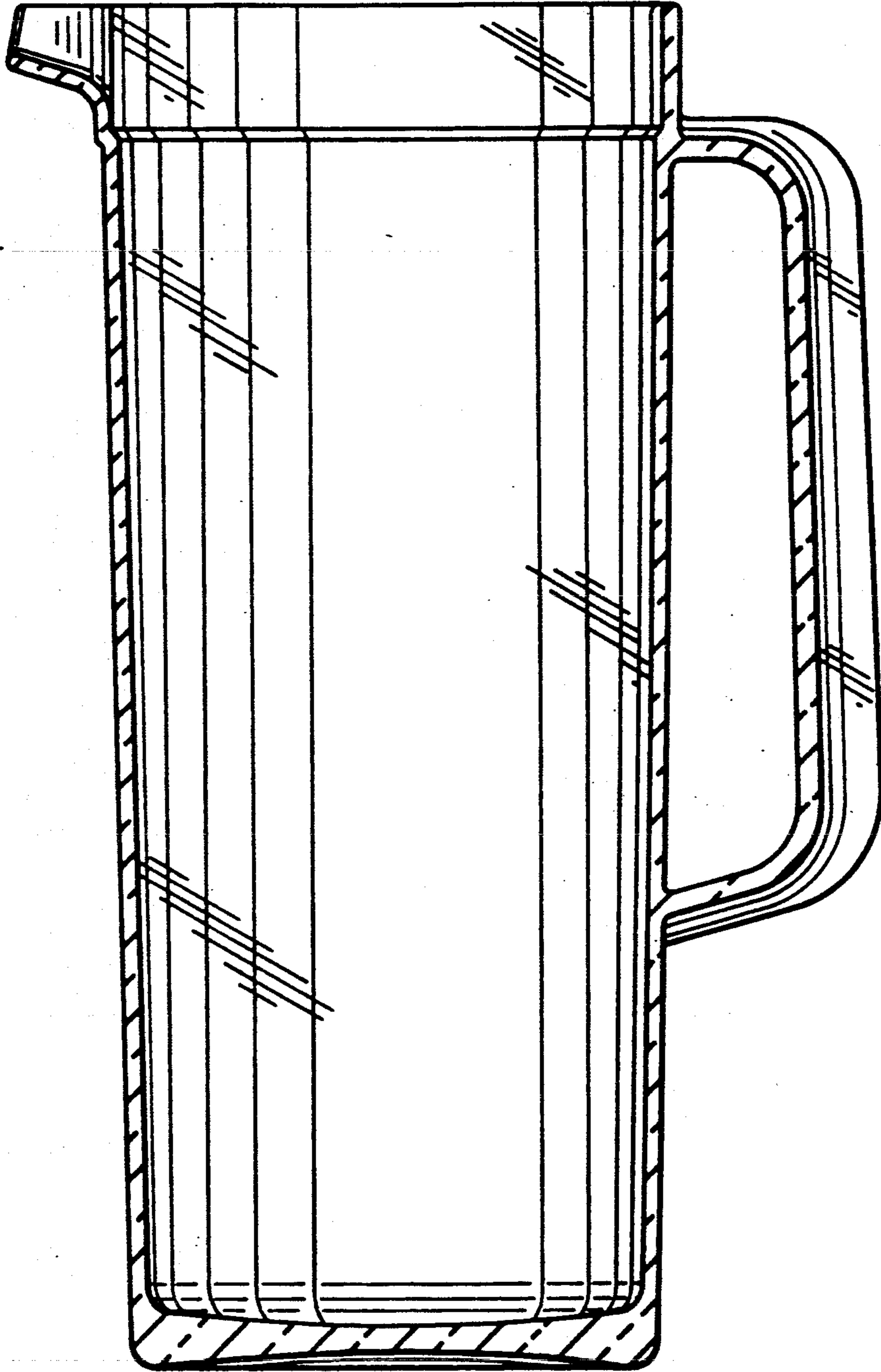

FIG. 7