



US00D323012S

# United States Patent [19]

[11] Patent Number: **Des. 323,012**

Antonious

[45] Date of Patent: **\*\* Jan. 7, 1992**

## [54] IRON TYPE GOLF CLUB HEAD

[76] Inventor: **Anthony J. Antonious**, 205 E. Joppa Rd., Towson, Md. 21204

[\*\*] Term: **14 Years**

[21] Appl. No.: **344,029**

[22] Filed: **Apr. 27, 1989**

[52] U.S. Cl. .... **D21/220**

[58] Field of Search ..... **D21/214-220;**  
**273/164, 167-175**

### [56] **References Cited**

#### **U.S. PATENT DOCUMENTS**

- D. 276,644 12/1984 Solheim ..... D21/220
- 4,332,388 6/1982 Crow ..... 273/167 A
- 4,630,825 12/1986 Schmidt et al. .... 273/167 H

*Primary Examiner*—Melvin B. Feifer  
*Attorney, Agent, or Firm*—Nicholas J. Aquilino

### [57] **CLAIM**

The ornamental design for an iron type golf club head, as shown and described.

### **DESCRIPTION**

FIG. 1 is a front perspective view of the iron type golf club head showing my new design;  
 FIG. 2 is a rear elevational view thereof.  
 FIG. 3 is an end elevational view thereof.  
 FIG. 4 is a top plan view thereof.  
 FIG. 5 is a bottom view thereof.  
 FIG. 6 is an end elevational view taken from the opposite side of FIG. 3.  
 FIG. 7 is a front elevational view thereof.

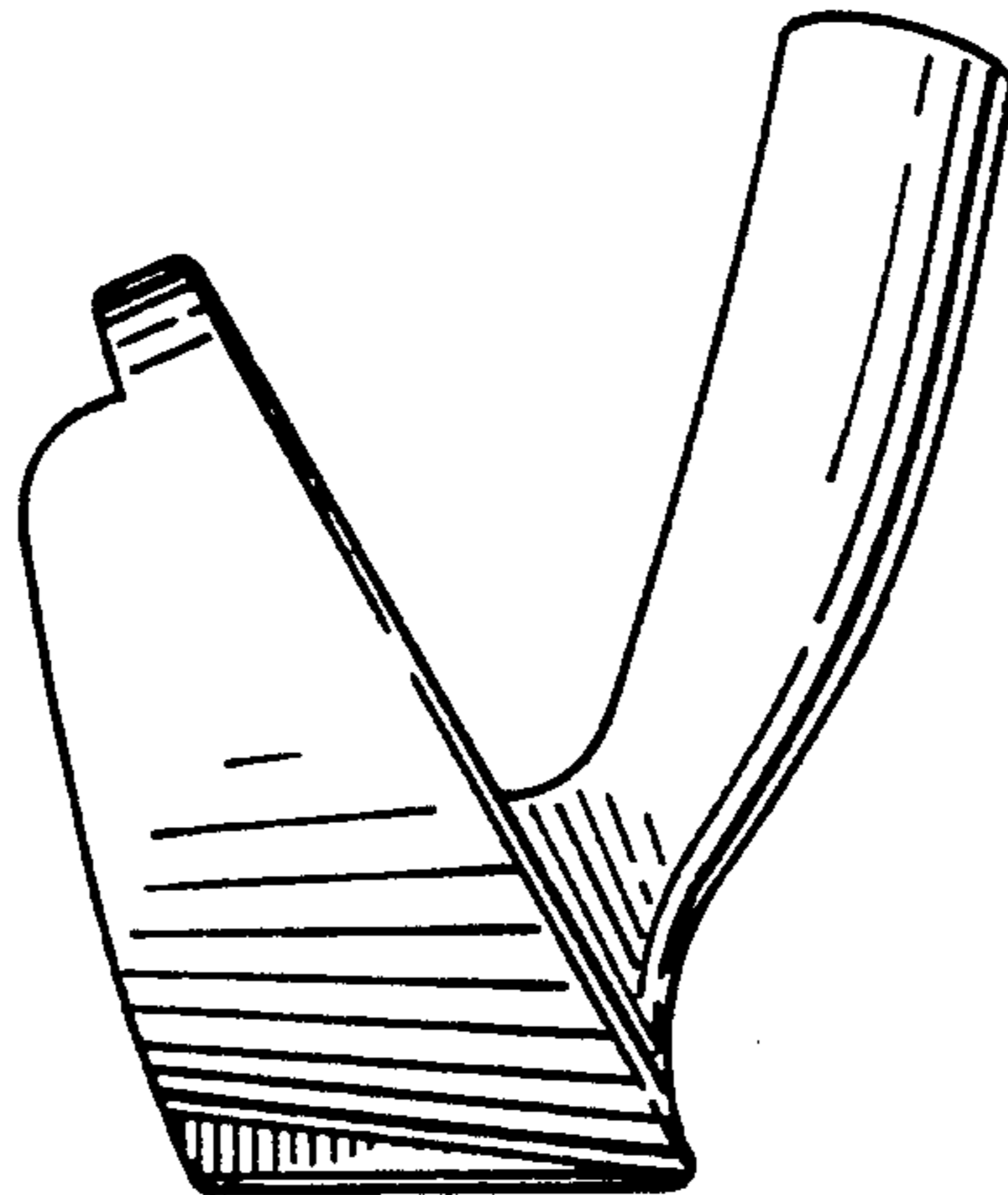
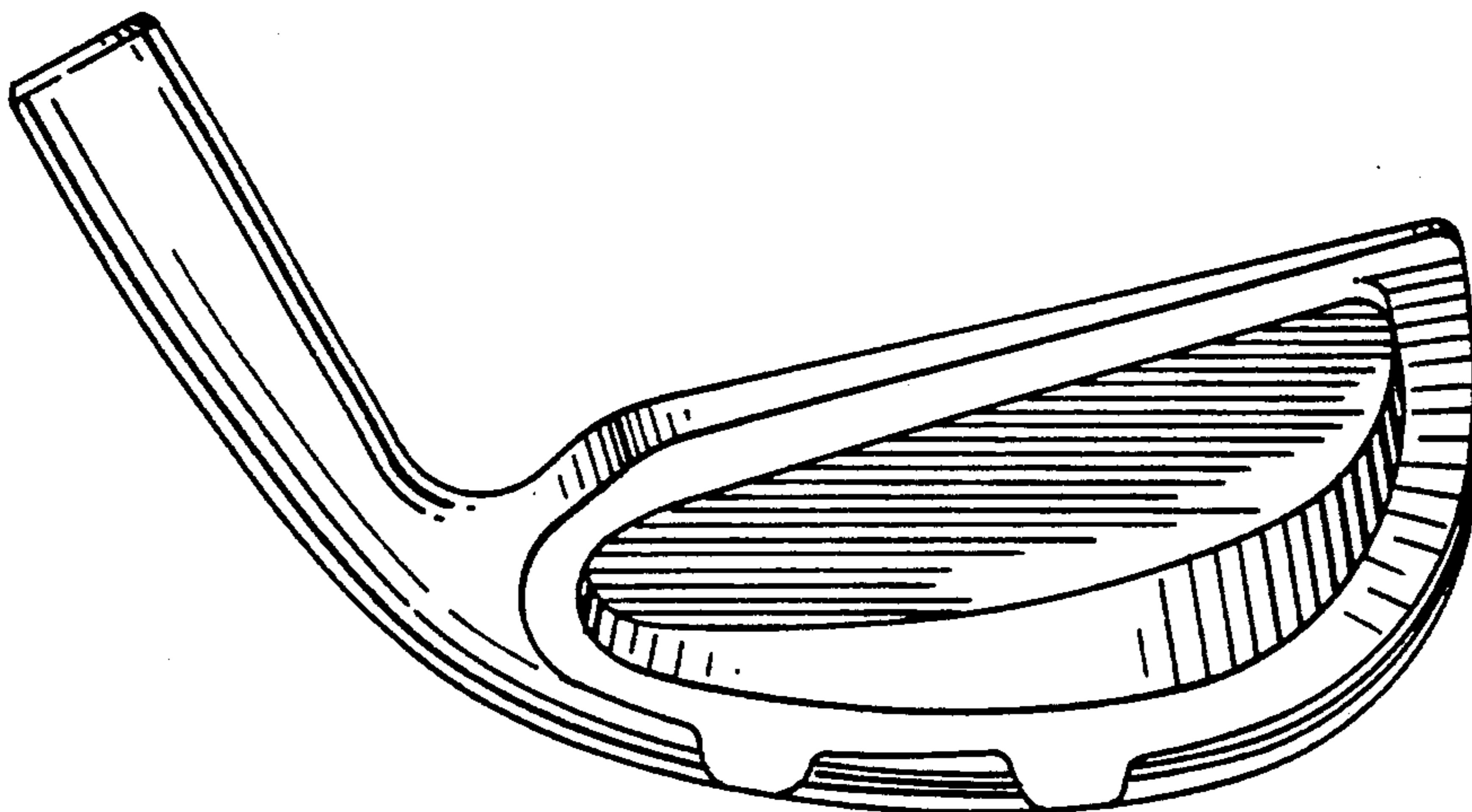

**FIG. 1**

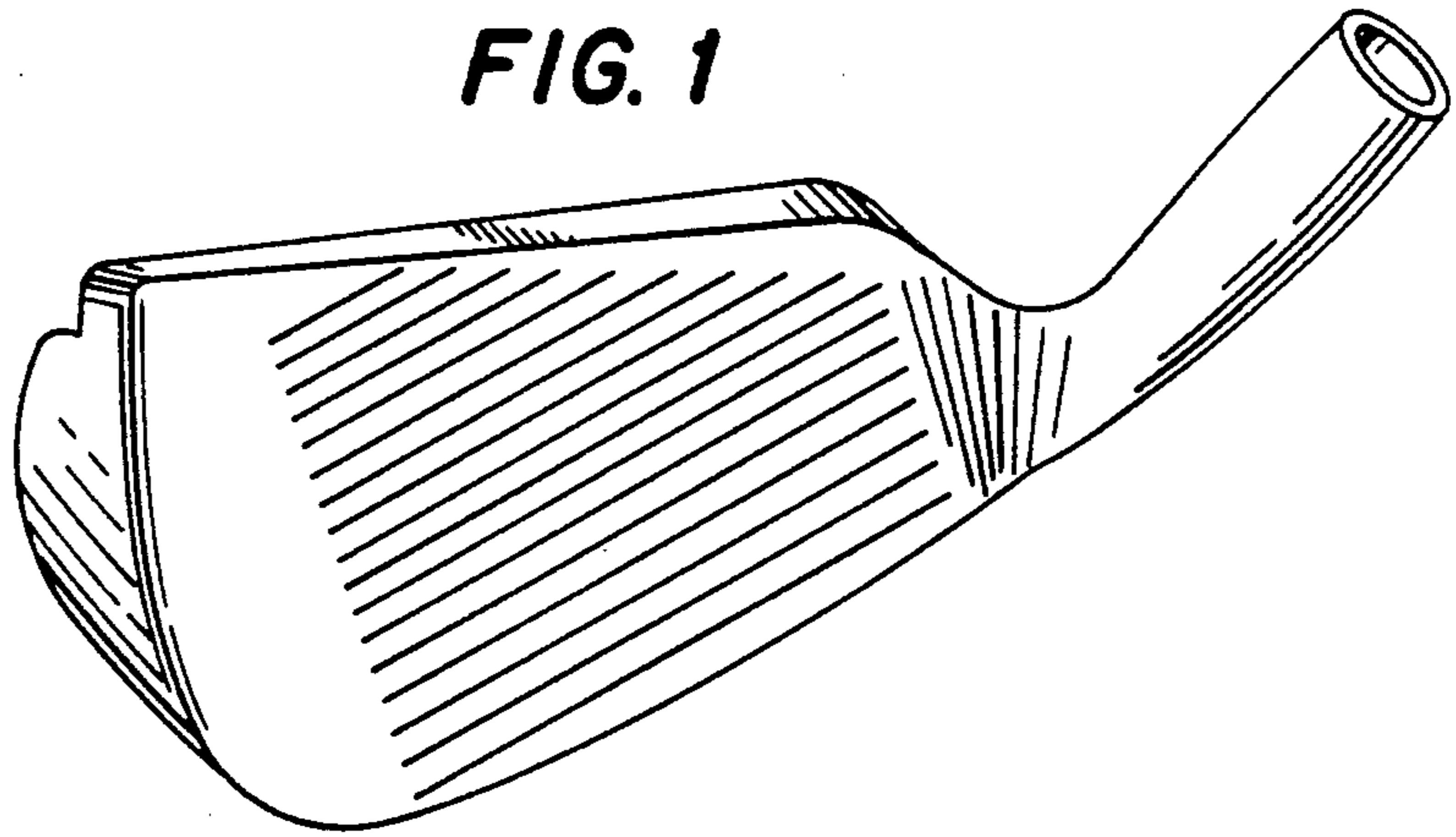

**FIG. 2**

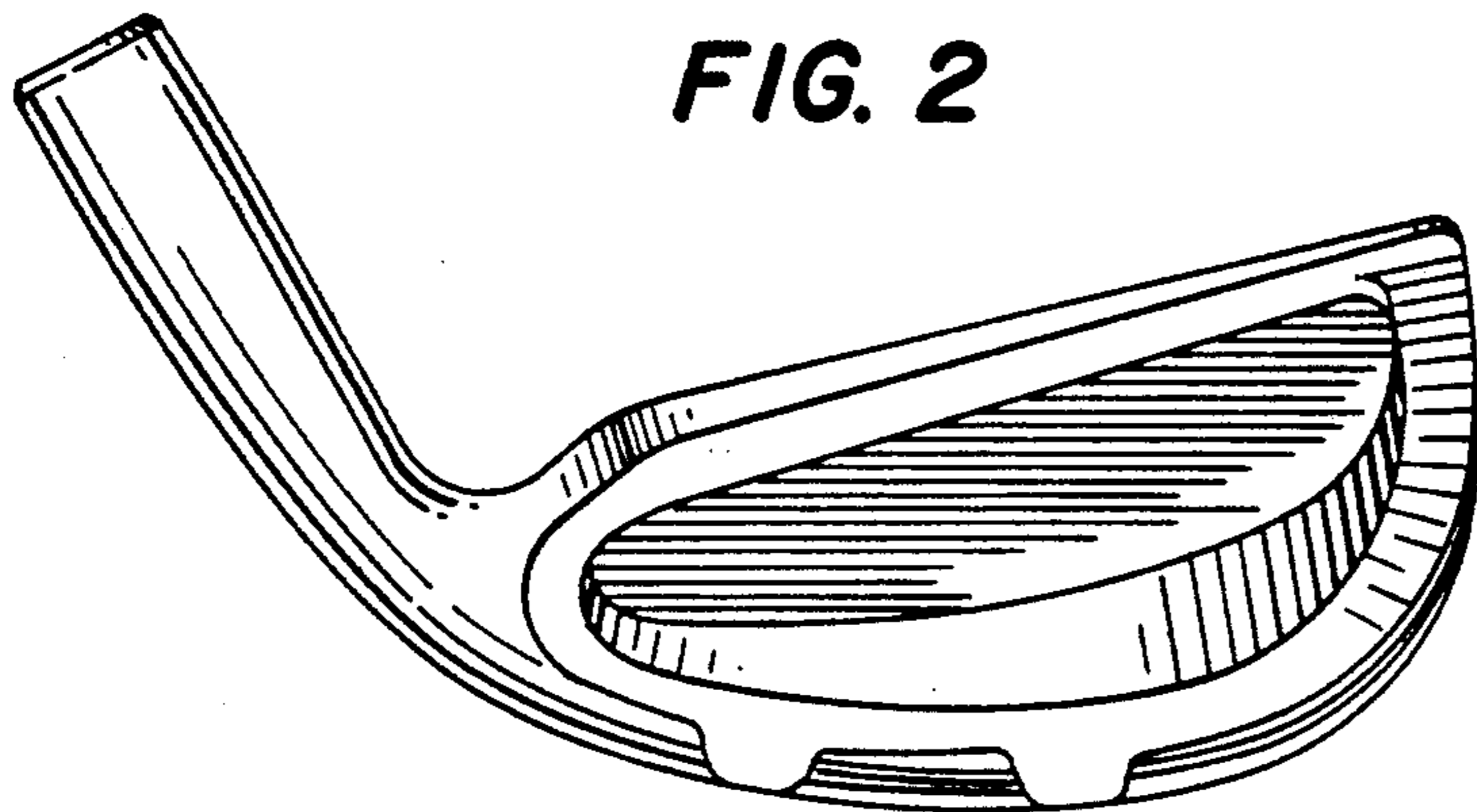

**FIG. 3**

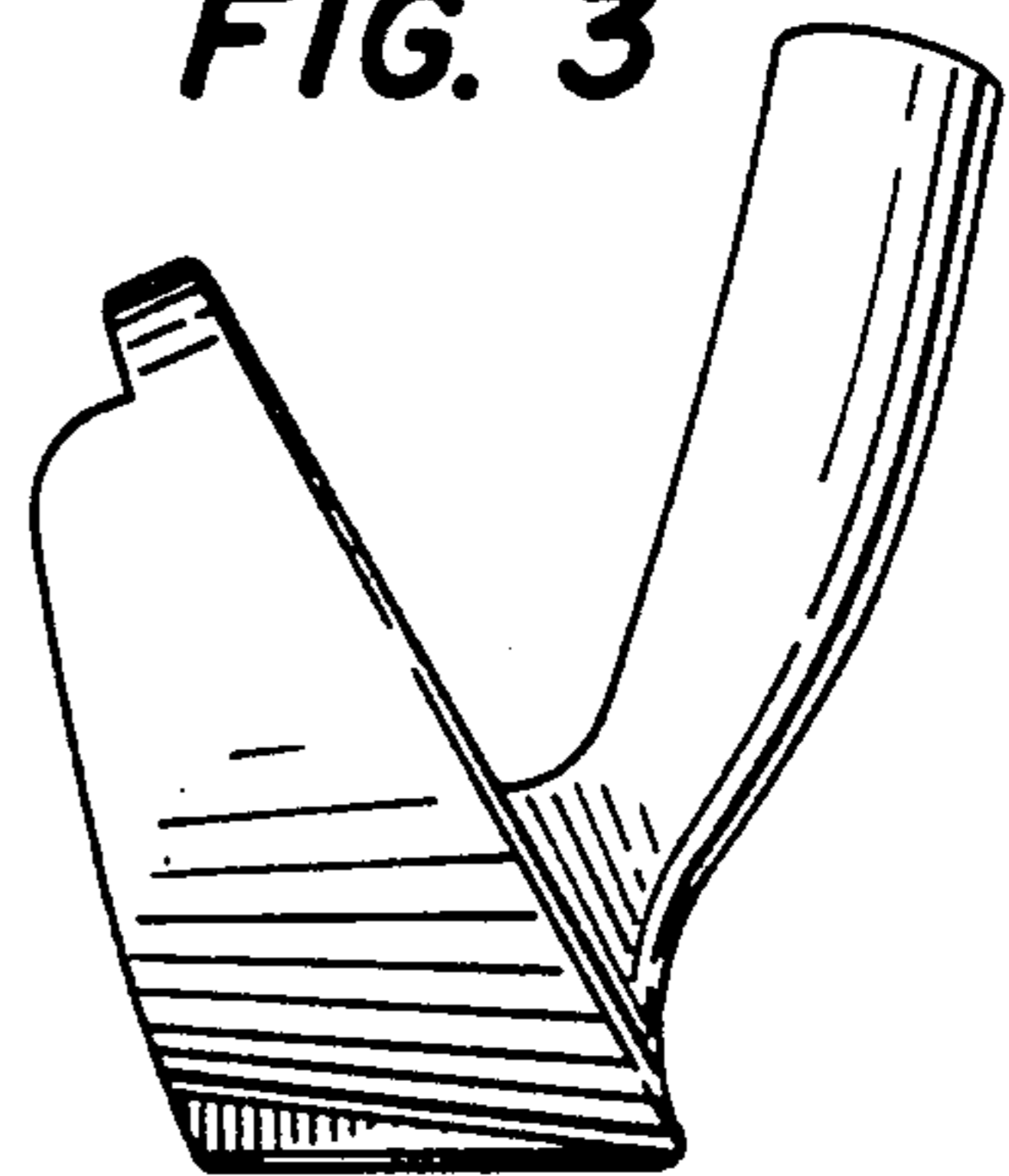

**FIG. 4**

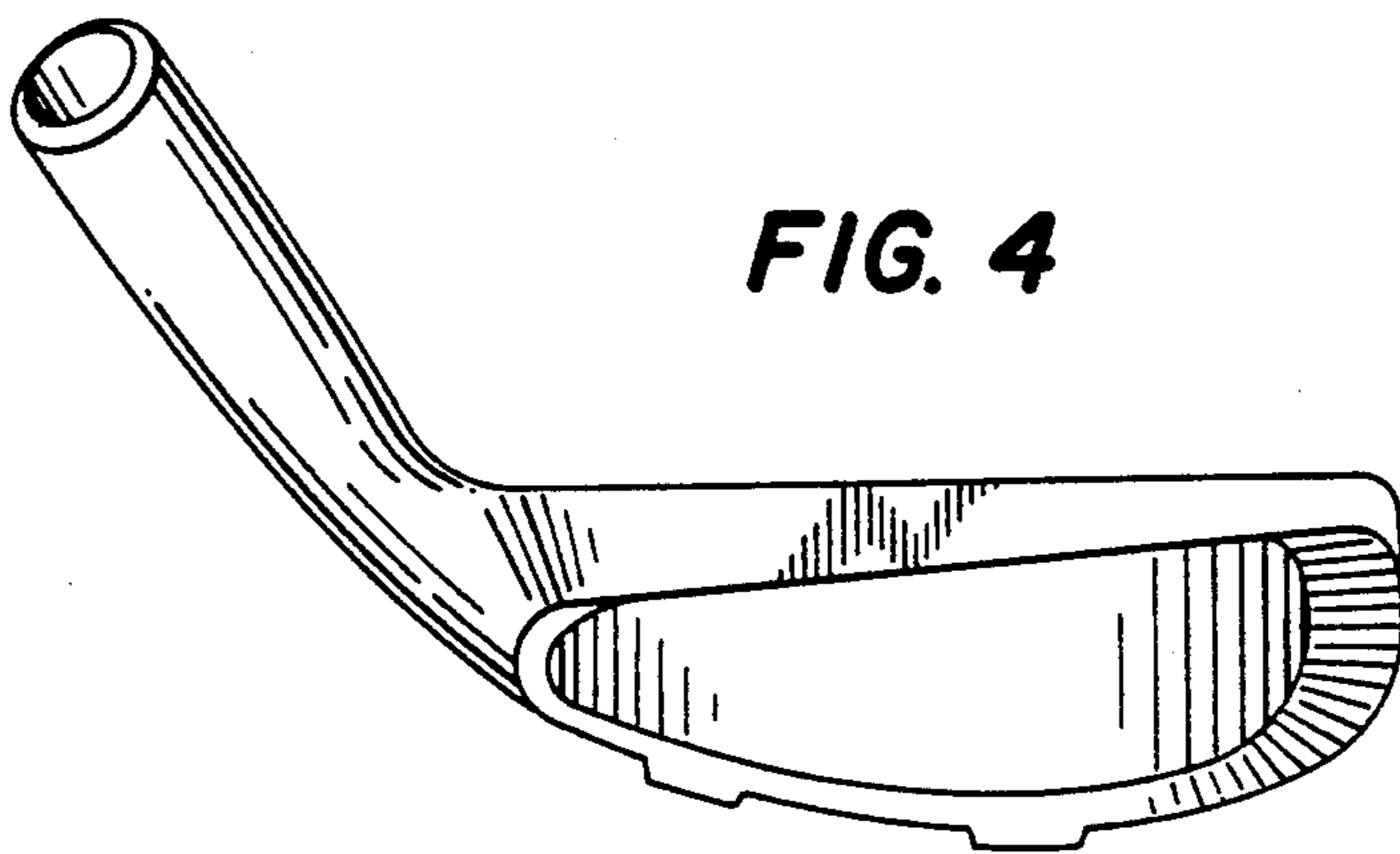

**FIG. 5**

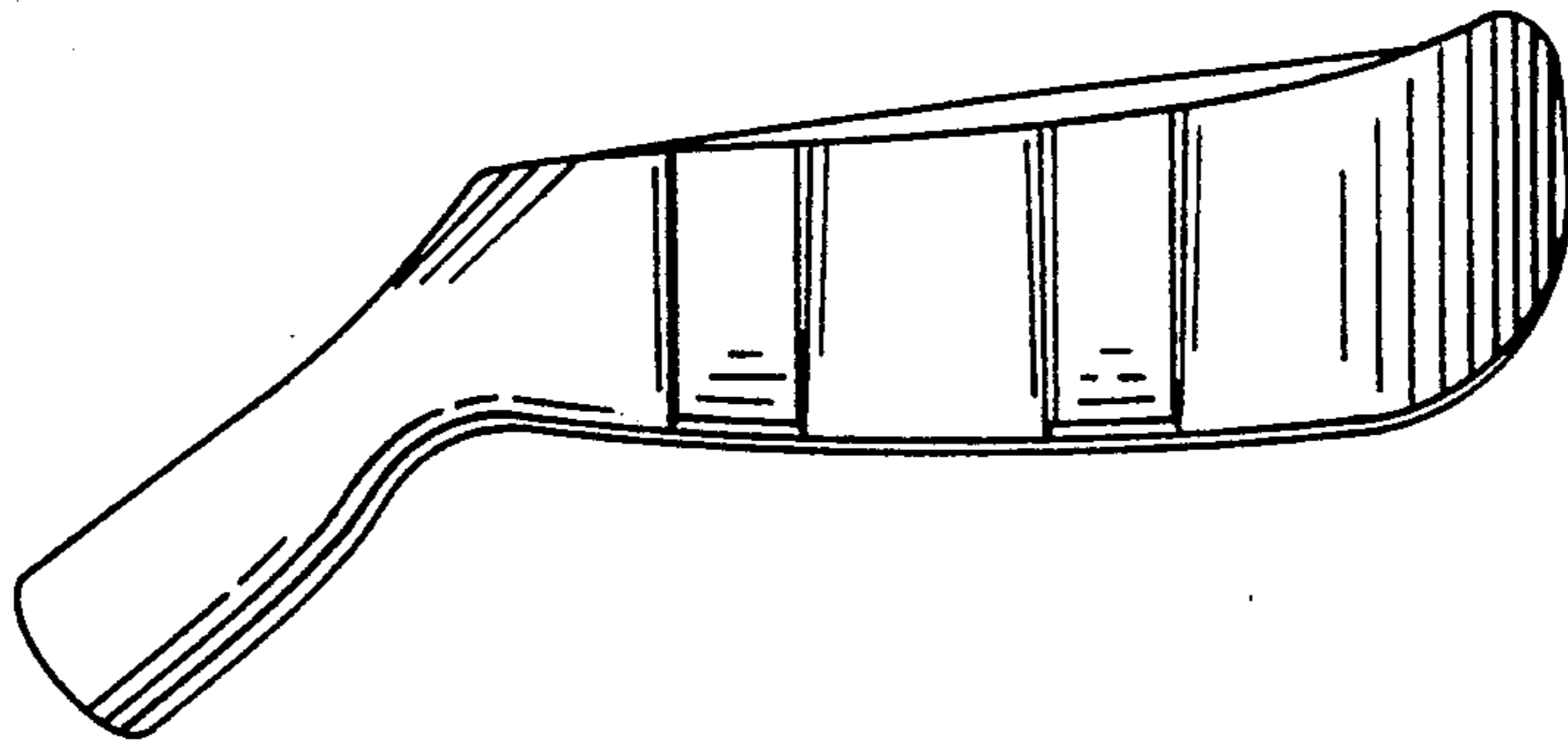

**FIG. 6**

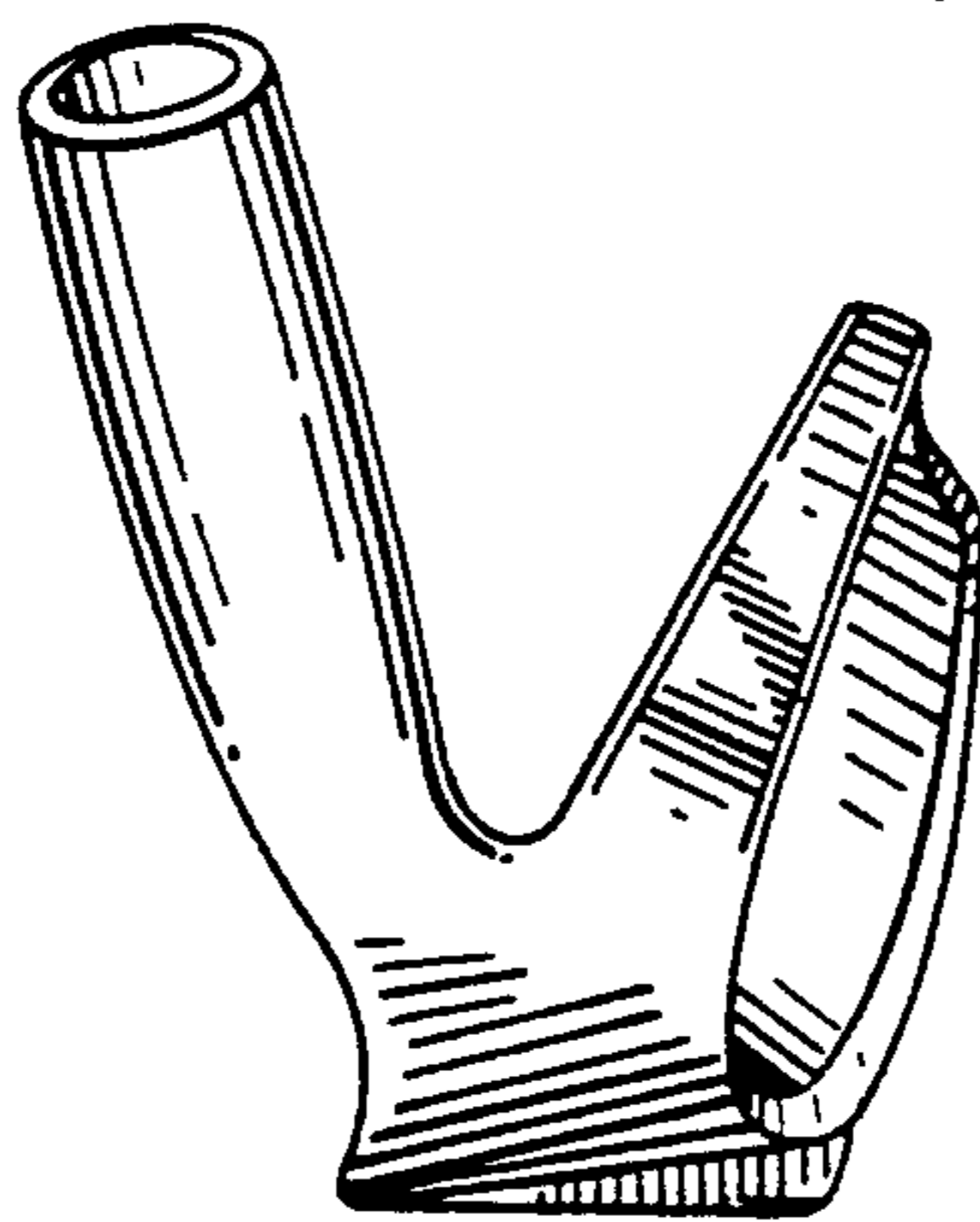

**FIG. 7**

