



US00D322964S

# United States Patent [19]

Ito et al.

[11] Patent Number: **Des. 322,964**

[45] Date of Patent: **\*\* Jan. 7, 1992**

[54] **STREAMING CASSETTE TAPE DRIVE**

[75] Inventors: **Masafumi Ito**, Tokyo; **Shigeru Hasegawa**, Kodaira; **Minoru Sube**, Hachioji; **Katsuhiko Takashima**, Yokohama; **Keiji Tsunoda**, Kokubunji, all of Japan

[73] Assignee: **TEAC Corporation**, Japan

[\*\*] Term: **14 Years**

[21] Appl. No.: **352,137**

[22] Filed: **May 15, 1989**

[30] **Foreign Application Priority Data**

Nov. 21, 1988 [JP] Japan ..... 63-45337

[52] U.S. Cl. .... **D14/108**

[58] Field of Search ..... D14/100, 102, 103, 105, D14/108, 109, 135, 161; D13/162, 184, 199; D6/509-512; 360/97.01-99.12, 137; 361/330-335, 390-395, 399, 415; 312/138.1, 208

[56] **References Cited**

**U.S. PATENT DOCUMENTS**

D. 265,091	6/1982	Hutcheson .....	D14/107
D. 280,624	9/1985	Swan et al. ....	D14/109
D. 290,844	7/1987	Shibuya et al. ....	D14/109
D. 308,515	6/1990	Stead .....	D14/100
D. 314,562	2/1991	Ito et al. ....	D14/108

*Primary Examiner*—Wallace R. Burke  
*Assistant Examiner*—Freda S. Nunn  
*Attorney, Agent, or Firm*—Andrus, Scales, Starke & Sawall

[57] **CLAIM**

The ornamental design for a streaming cassette tape drive, as shown and described.

**DESCRIPTION**

FIG. 1 is a front elevational view of a streaming cassette tape drive showing our new design; FIG. 2 is a rear elevational view thereof; FIG. 3 is a top plan view thereof; FIG. 4 is a bottom plan view thereof; FIG. 5 is a left side elevational view thereof; FIG. 6 is a right side elevational view thereof; FIG. 7 is a top left side perspective view thereof.

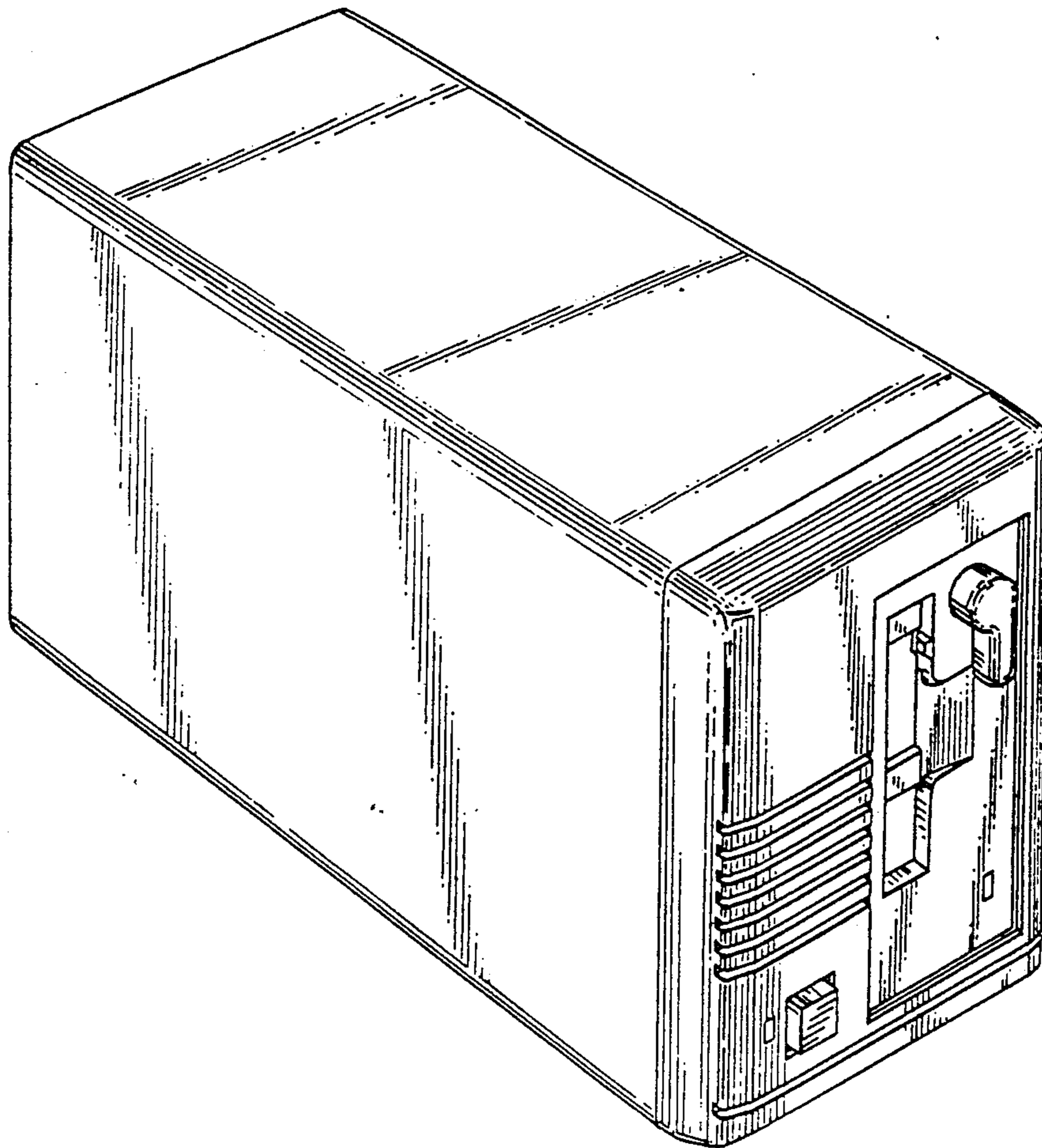

FIG. 1

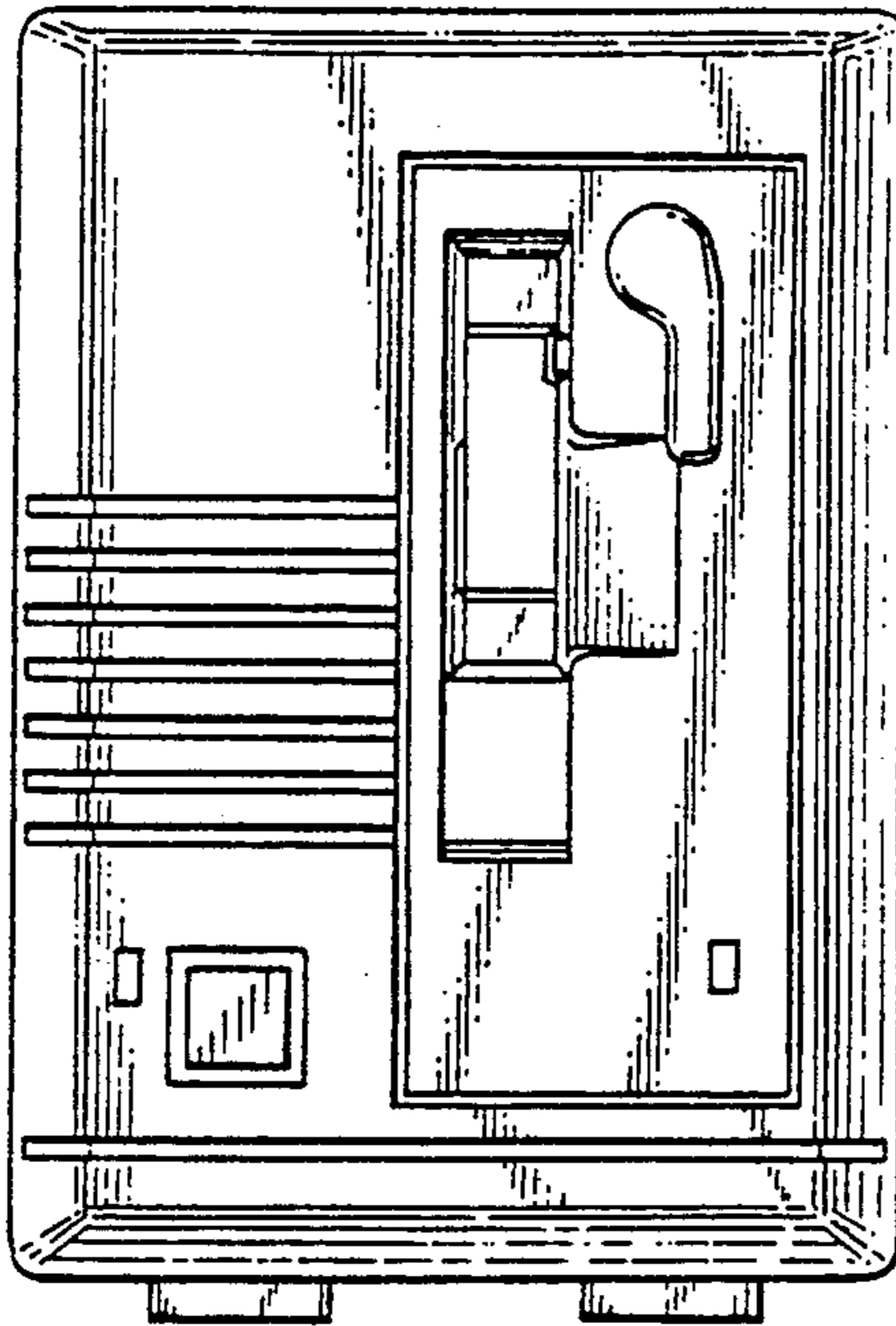

FIG. 2

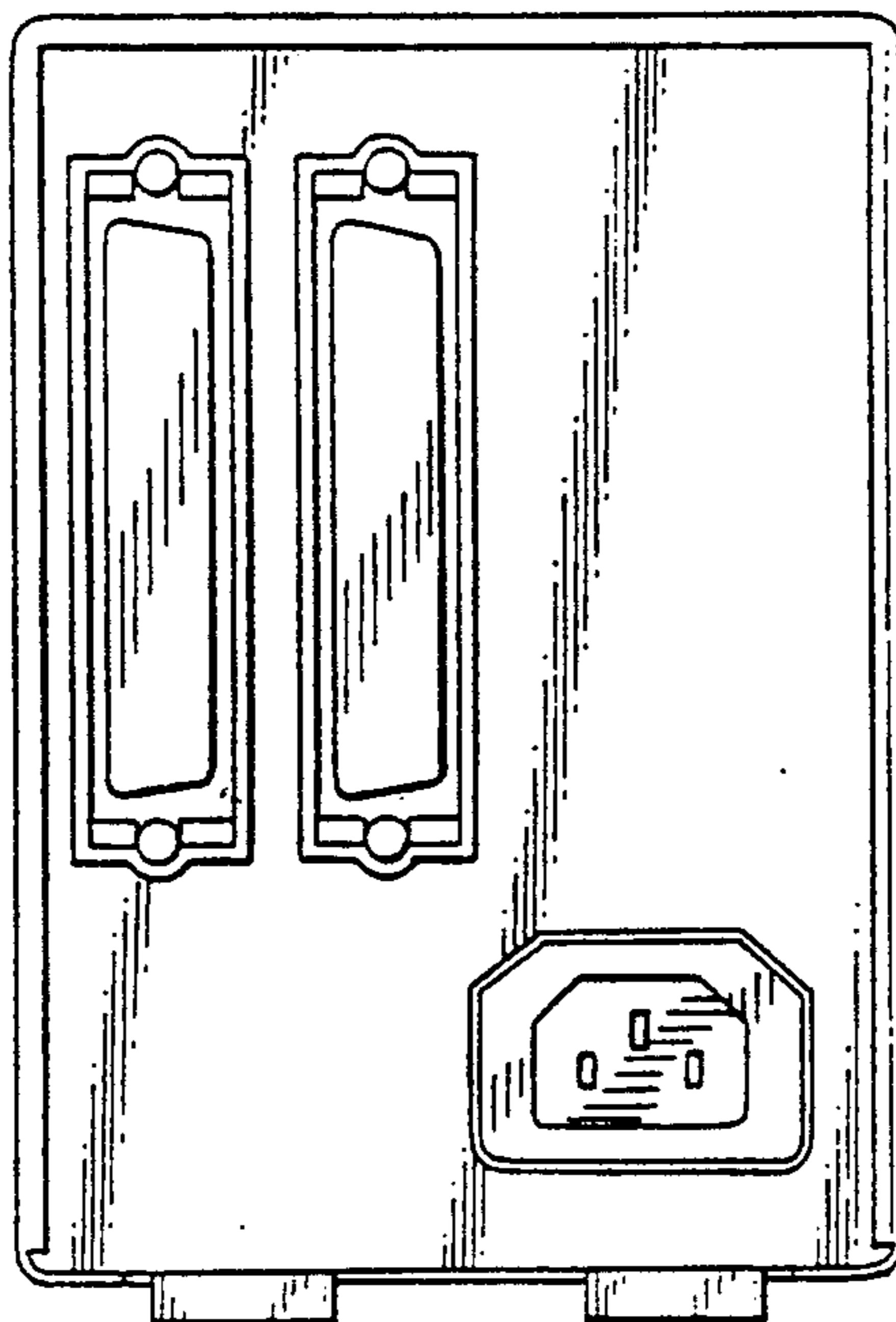

FIG. 3

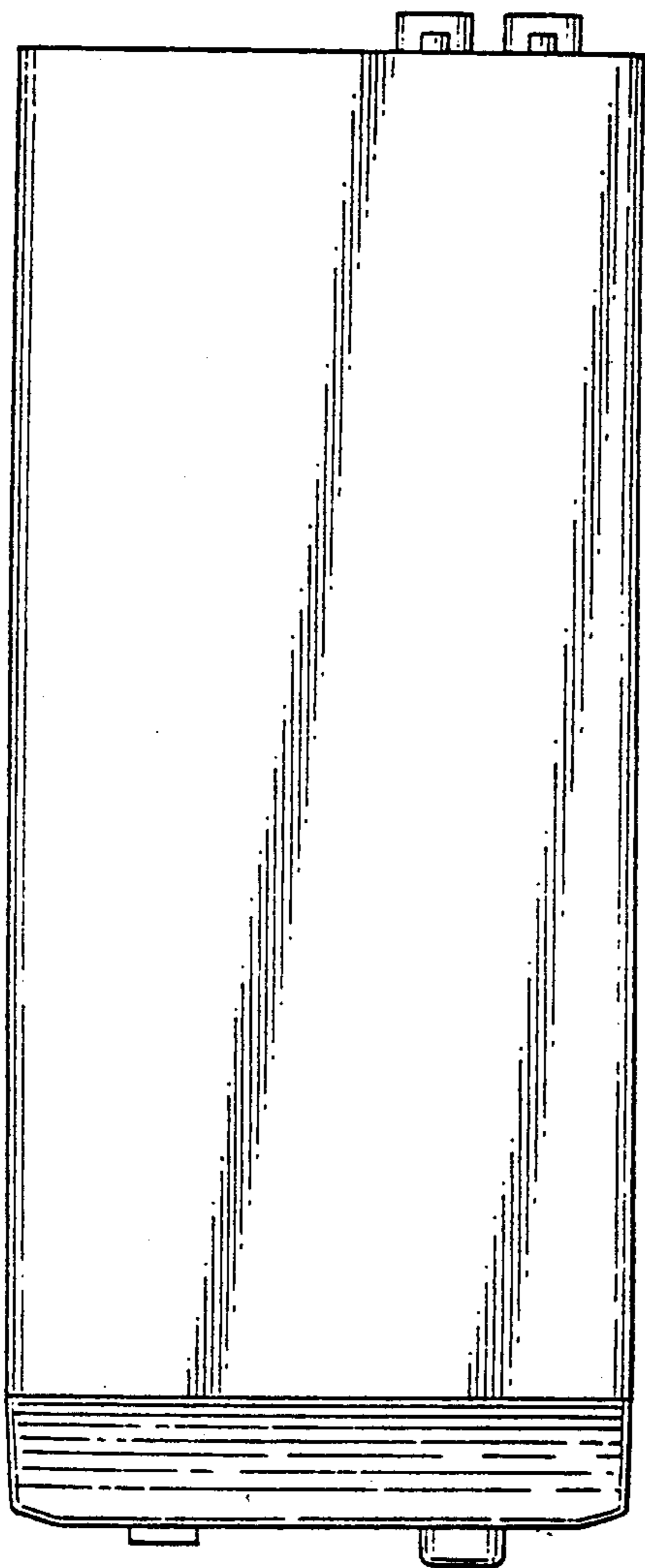

FIG. 4

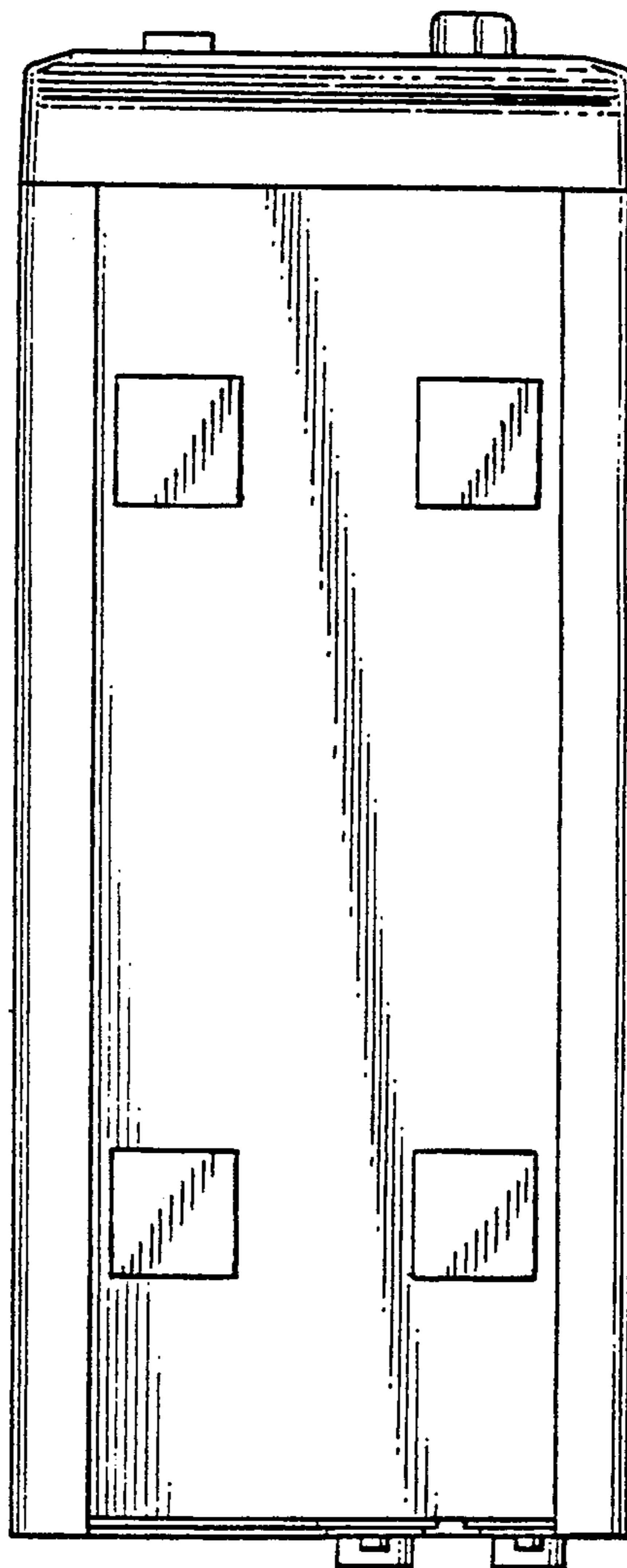

FIG. 5

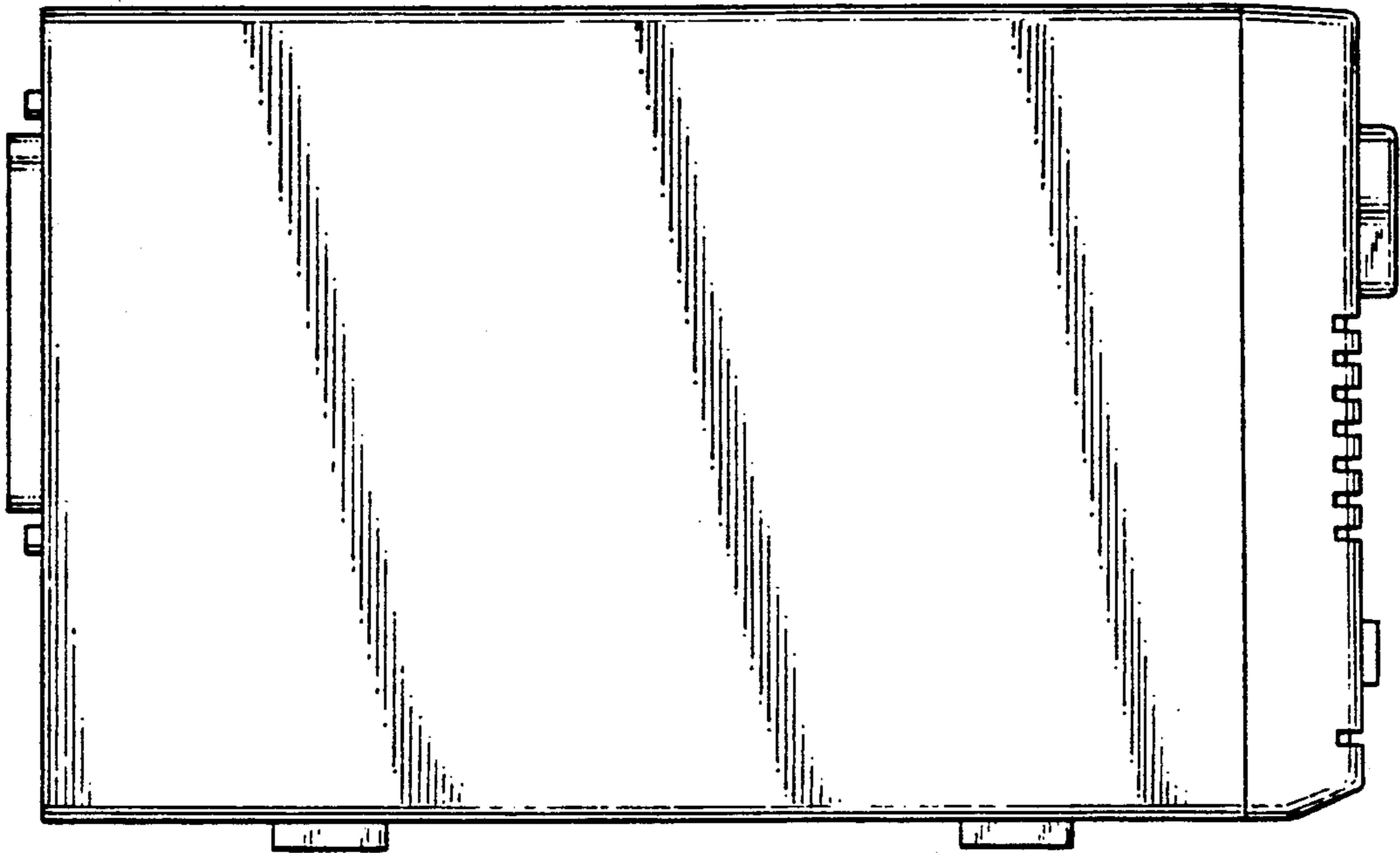

FIG. 6

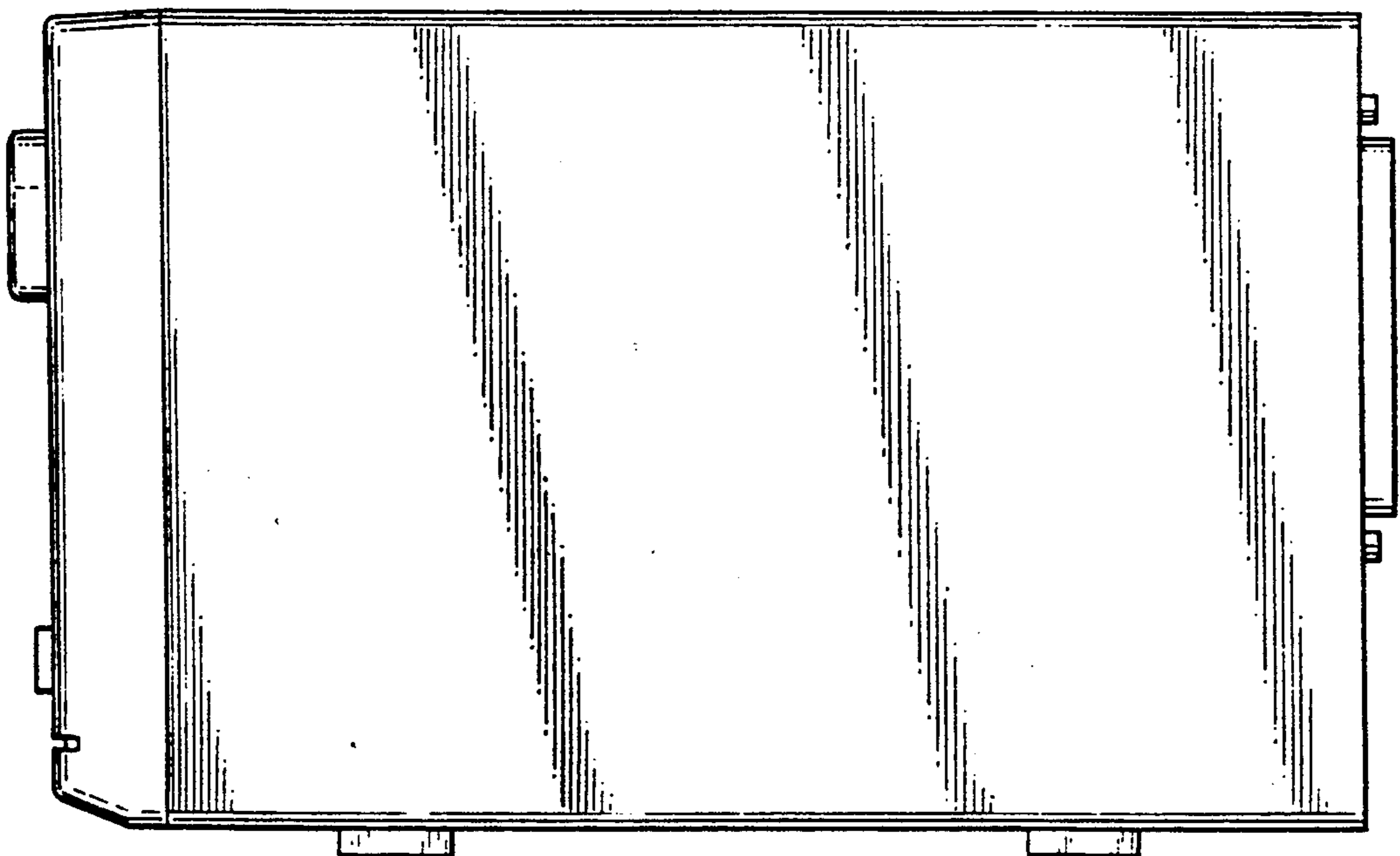

FIG. 7

