

United States Patent [19]

Favre

[11] Patent Number: **Des. 322,865**

[45] Date of Patent: **** Dec. 31, 1991**

[54] **COSMETIC BOX**

[75] Inventor: **Bernard Favre, Chevilly-Larue, France**

[73] Assignee: **Lir France, Chevilly Larue, France**

[**] Term: **14 Years**

[21] Appl. No.: **387,575**

[22] Filed: **Jul. 31, 1989**

[30] **Foreign Application Priority Data**

Apr. 7, 1989 [FR] France 89 2344

[52] U.S. Cl. **D28/83; D9/347; D28/76**

[58] **Field of Search** **D28/61, 73-84; D3/30.1, 39, 75; D9/337, 338, 341, 347, 414, 420, 430, 423; 132/286, 294; 206/735, 823, 581; 220/DIG. 26**

[56] **References Cited**

U.S. PATENT DOCUMENTS

D. 105,972	9/1937	Steiner	D28/83
D. 144,909	6/1946	Crane	D9/347 X
D. 221,117	7/1971	Jacobs	D3/39
D. 268,292	3/1983	Chevassus	D8/83
D. 278,207	4/1985	McLaughlin	D9/339
D. 286,212	10/1986	Campello et al.	D28/83
D. 290,297	6/1987	Schemmer	D28/78

1,753,315 4/1930 Parent 132/297
4,744,376 5/1988 Verducci 220/DIG. 26 X

OTHER PUBLICATIONS

Hong Kong Enterprise; 5/1986, p. 225, #s 8503 and 8504.

Beauty Fashion; 1/1988; p. 70: bottom half of page, top row, second from left.

Primary Examiner—Bernard Ansher

Assistant Examiner—C. Tuttle

Attorney, Agent, or Firm—Fleit, Jacobson, Cohn, Price, Holman & Stern

[57] **CLAIM**

The ornamental design for a cosmetic box, as shown and described.

DESCRIPTION

FIG. 1 is a top plan view of a cosmetic box, in an open position, showing my new design;

FIG. 2 is a top perspective view thereof;

FIG. 3 is a top plan view shown in an alternate position;

FIG. 4 is a top plan view in a closed position;

FIG. 5 is a bottom plan view thereof;

FIG. 6 is a front elevational view thereof, the side opposite being a mirror image of the side shown; and

FIG. 7 is a side elevational view thereof, the side opposite being a mirror image of the side shown.

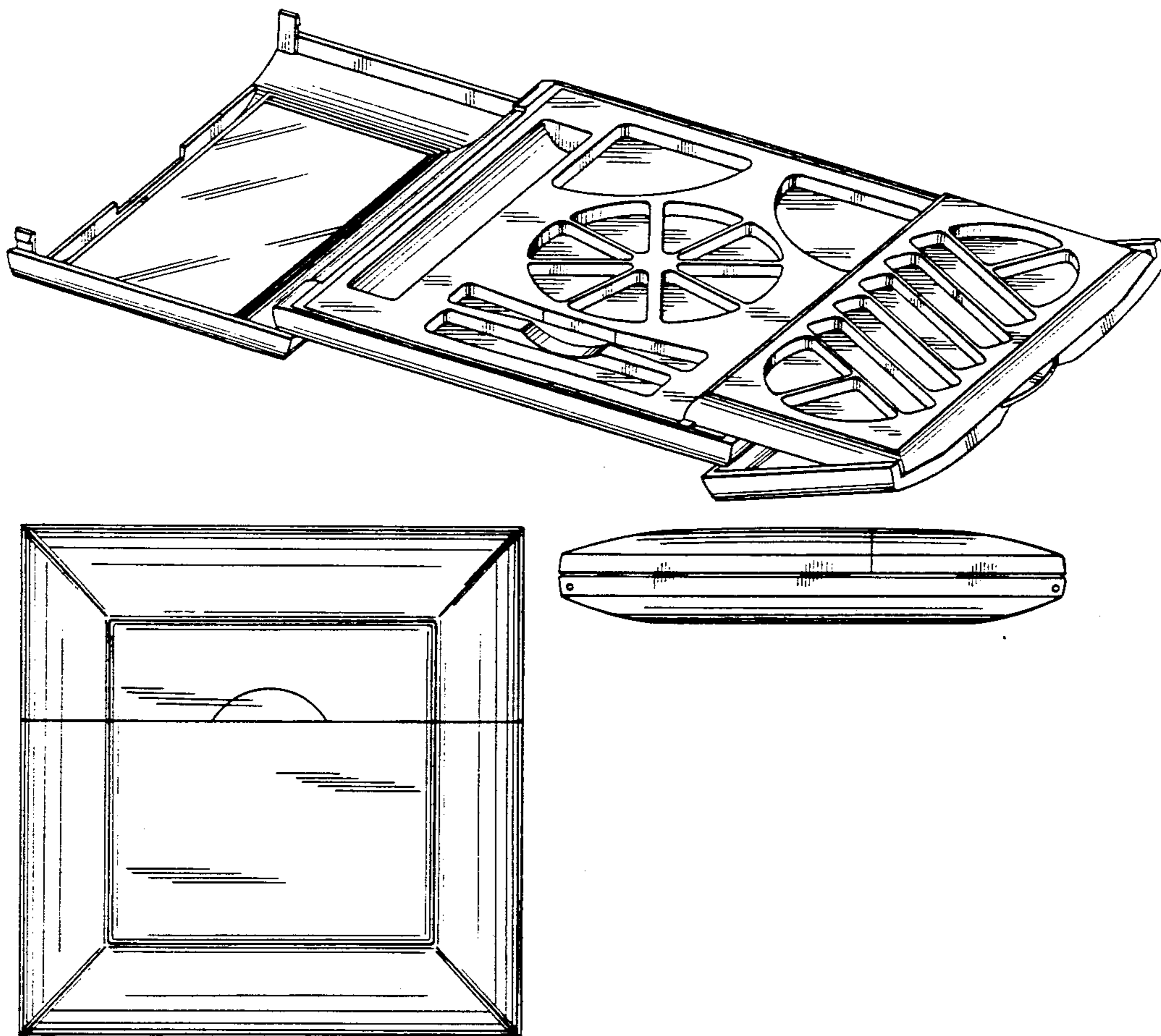

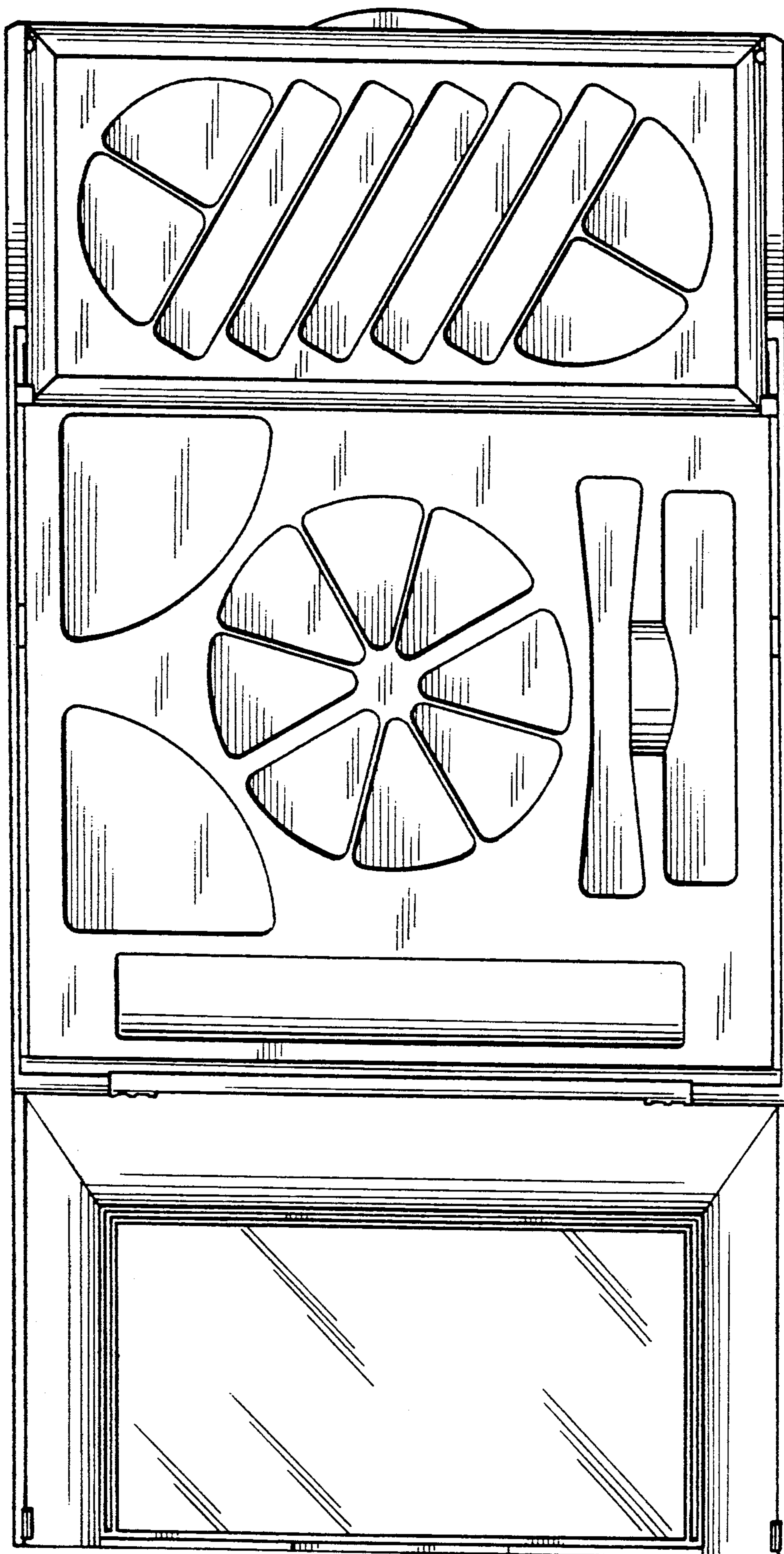

FIG. 1

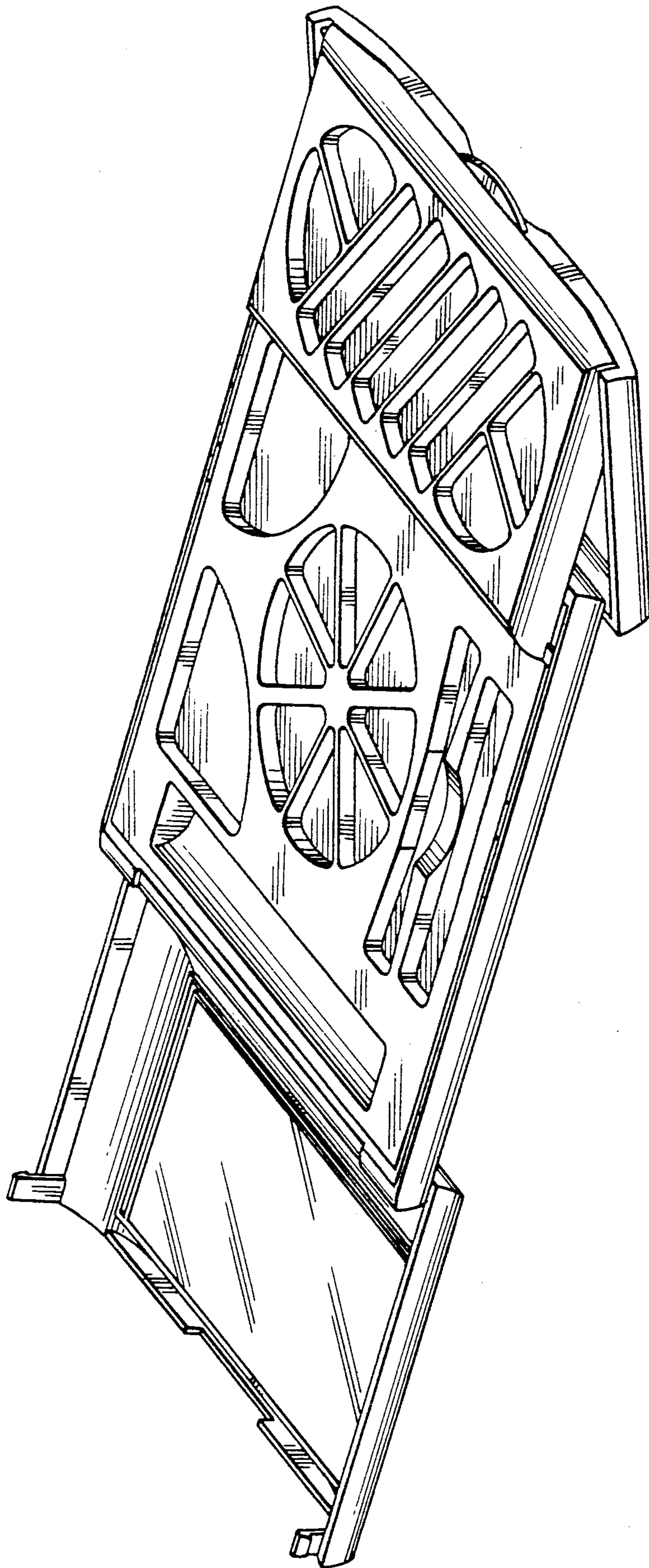

FIG. 2

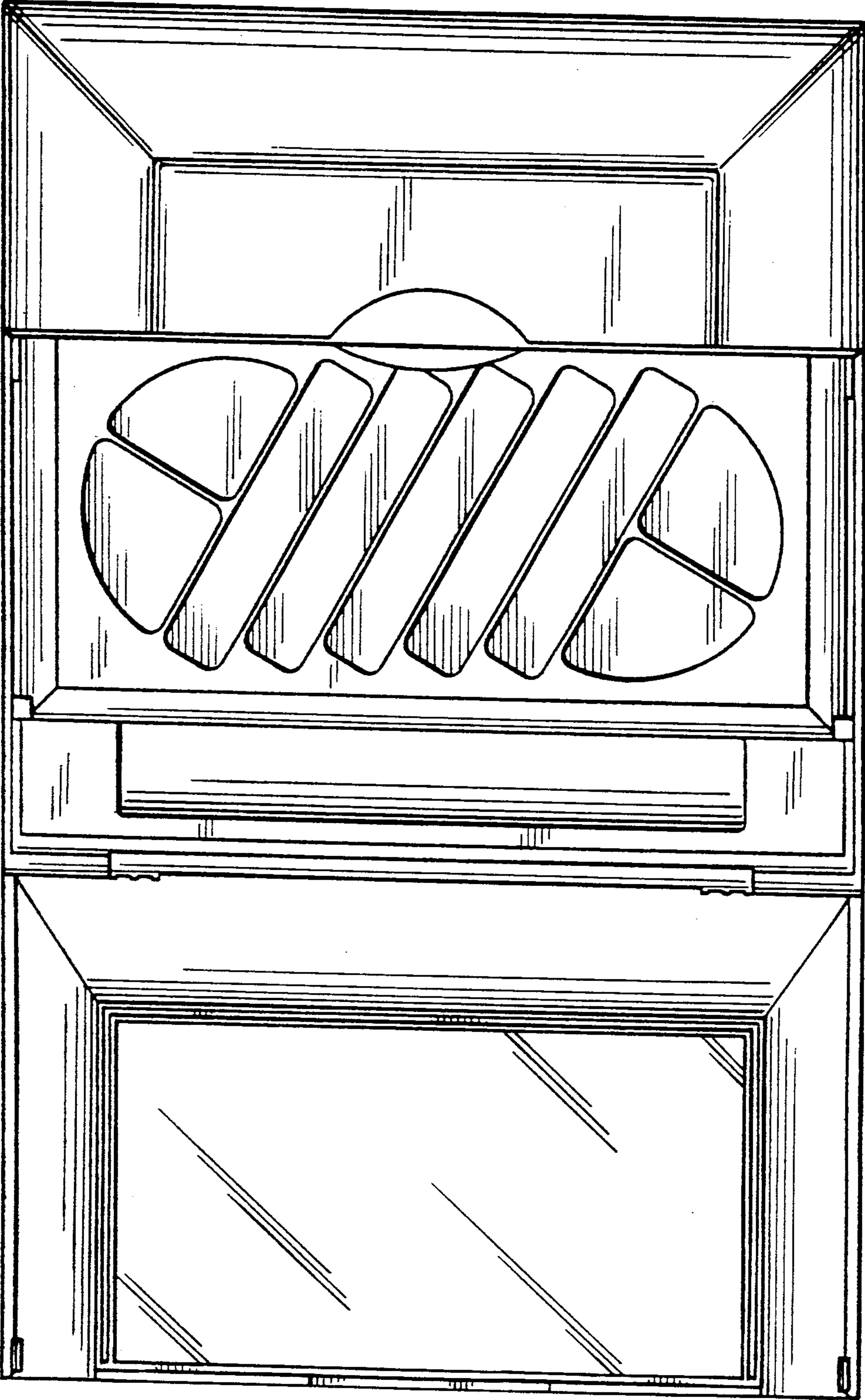

FIG. 3

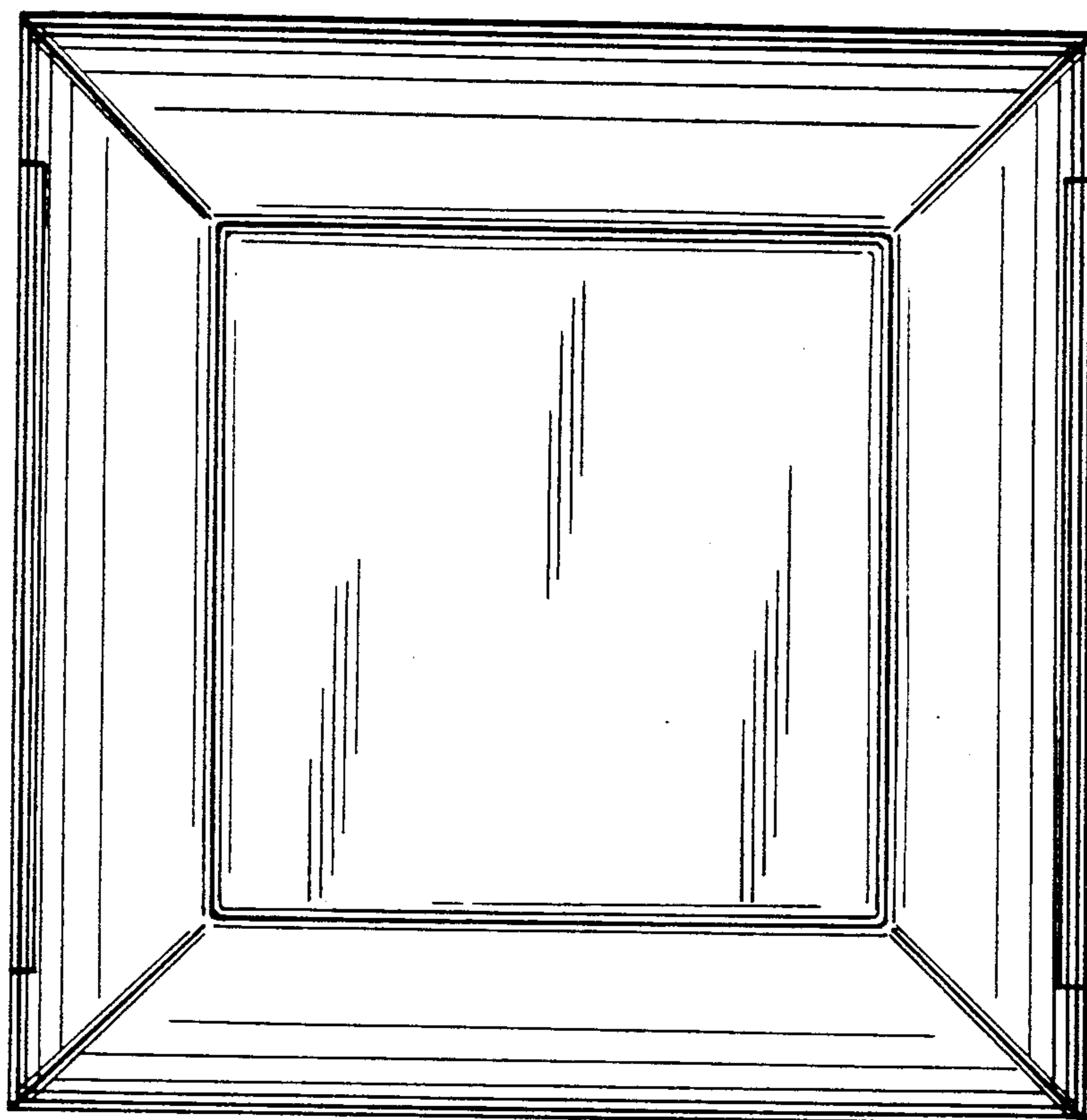

FIG. 5

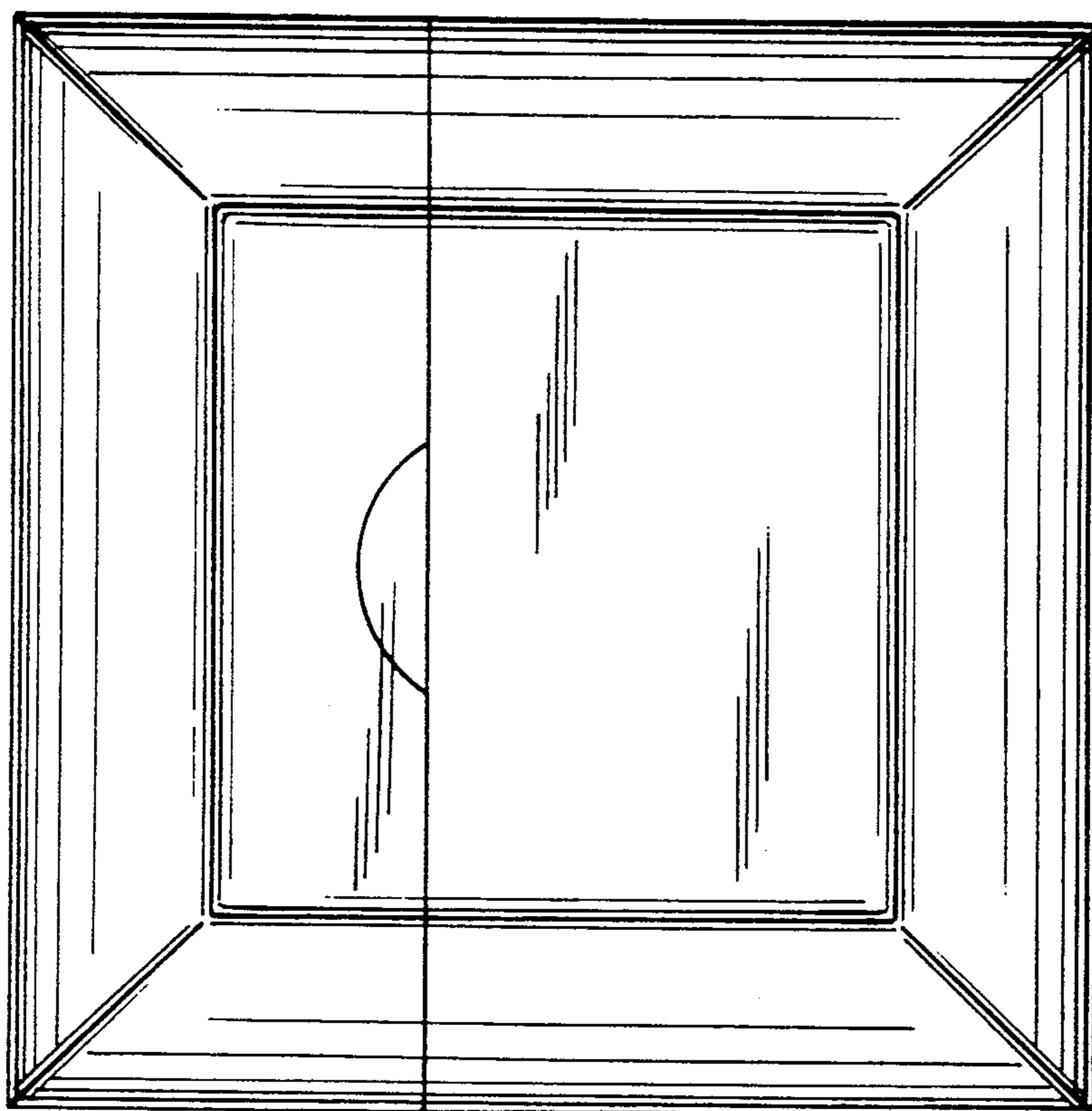

FIG. 4

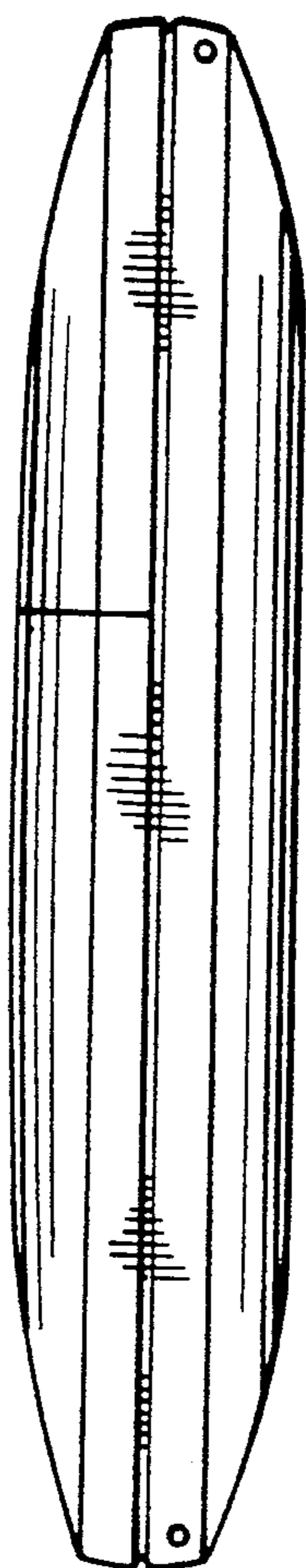
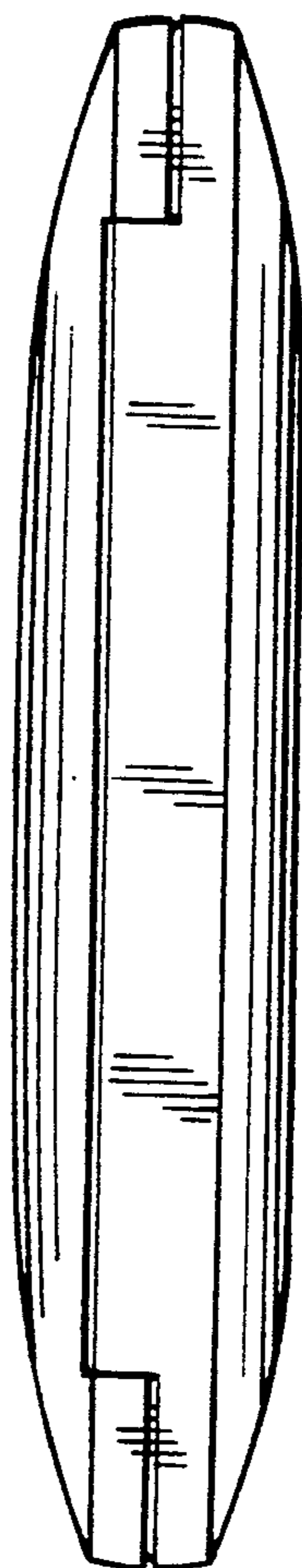

FIG. 6



"
FIG. 7