

[54] MOUNT FOR A FIREARM SIGHT

[57] CLAIM

[75] Inventor: Joseph A. Lawlor, Emon Valley, Pa.

The ornamental design for a mount for a firearm sight, as shown and described.

[73] Assignee: Progressive Sporting Goods, Inc., New Middletown, Ohio

DESCRIPTION

[\*\*] Term: 14 Years

FIG. 1 is a perspective view of a mount for a firearm sight showing my new design;

[21] Appl. No.: 306,461

FIG. 2 is a side elevational view thereof;

[22] Filed: Feb. 6, 1989

FIG. 3 is a top plan view thereof;

[52] U.S. Cl. .... D22/10

FIG. 4 is a bottom plan view thereof;

[58] Field of Search ..... D22/110; 33/245, 248, 33/250, 261, 259, 234; 42/72, 100-102; 248/205.1, 226.1, 226.4, 226.5, 229

FIG. 5 is an end elevational view thereof with the opposite end being a mirror image thereof;

FIG. 6 is an opposite side elevational view thereof;

[56] References Cited

U.S. PATENT DOCUMENTS

- D. 216,014 11/1969 Dupont ..... D22/110
- D. 269,989 8/1983 Ross ..... D22/110
- D. 318,313 7/1991 Bechtel ..... D22/110

FIG. 7 is a perspective view of a second embodiment of the design shown in FIG. 1;

FIG. 8 is a side elevational view thereof;

FIG. 9 is a top plan view thereof;

FIG. 10 is a bottom plan view thereof;

FIG. 11 is an end elevational view thereof;

FIG. 12 is an opposite side elevational view thereof;

FIG. 13 is a perspective view of a third embodiment of the design shown in FIG. 1;

FIG. 14 is a side elevational view thereof;

FIG. 15 is a top plan view thereof;

FIG. 16 is a bottom plan view thereof;

FIG. 17 is an end elevational view thereof with the opposite end being a mirror image thereof; and

FIG. 18 is an opposite side elevational view thereof.

Primary Examiner—Wallace R. Burke  
Assistant Examiner—H. Baynham  
Attorney, Agent, or Firm—Clifford A. Poff

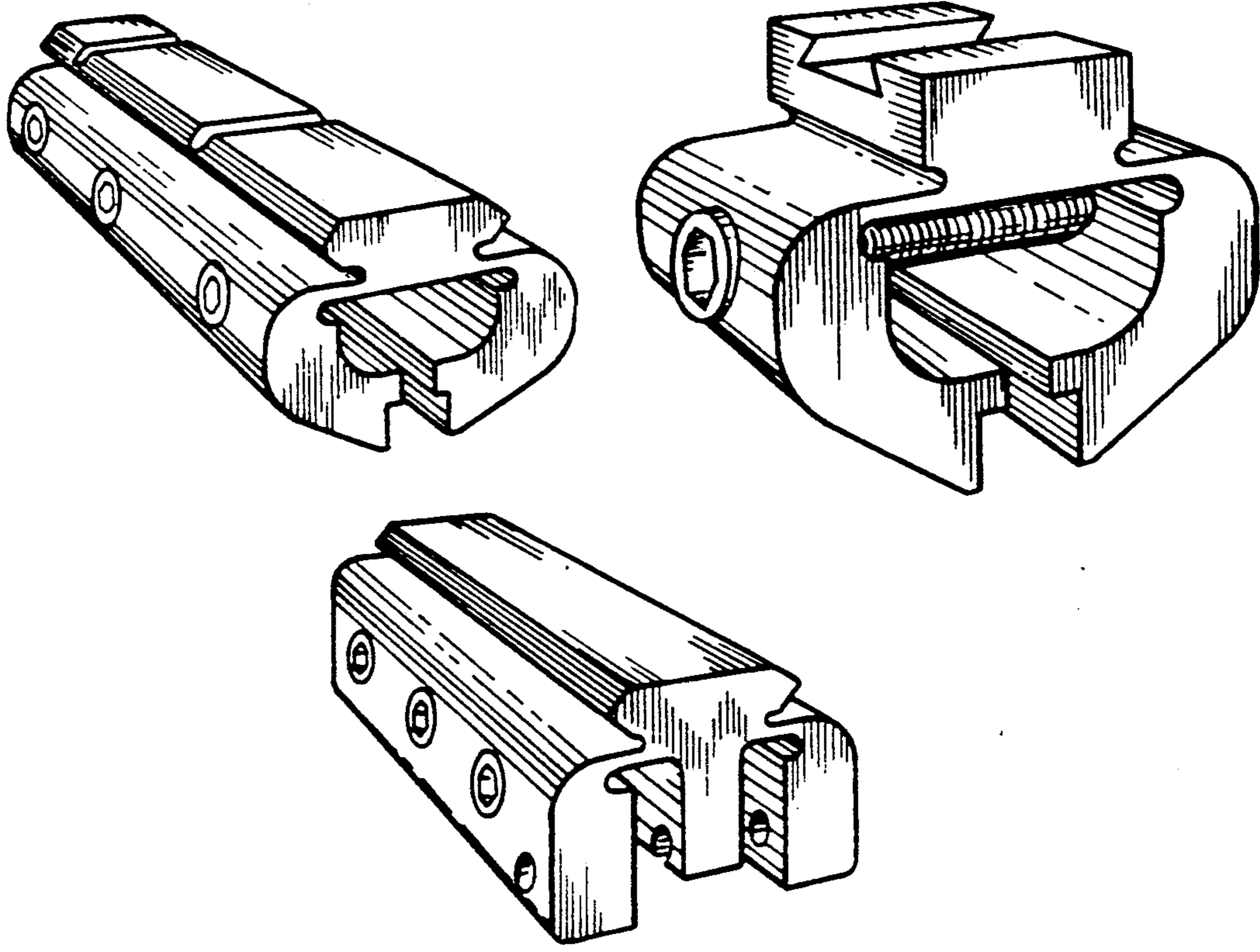

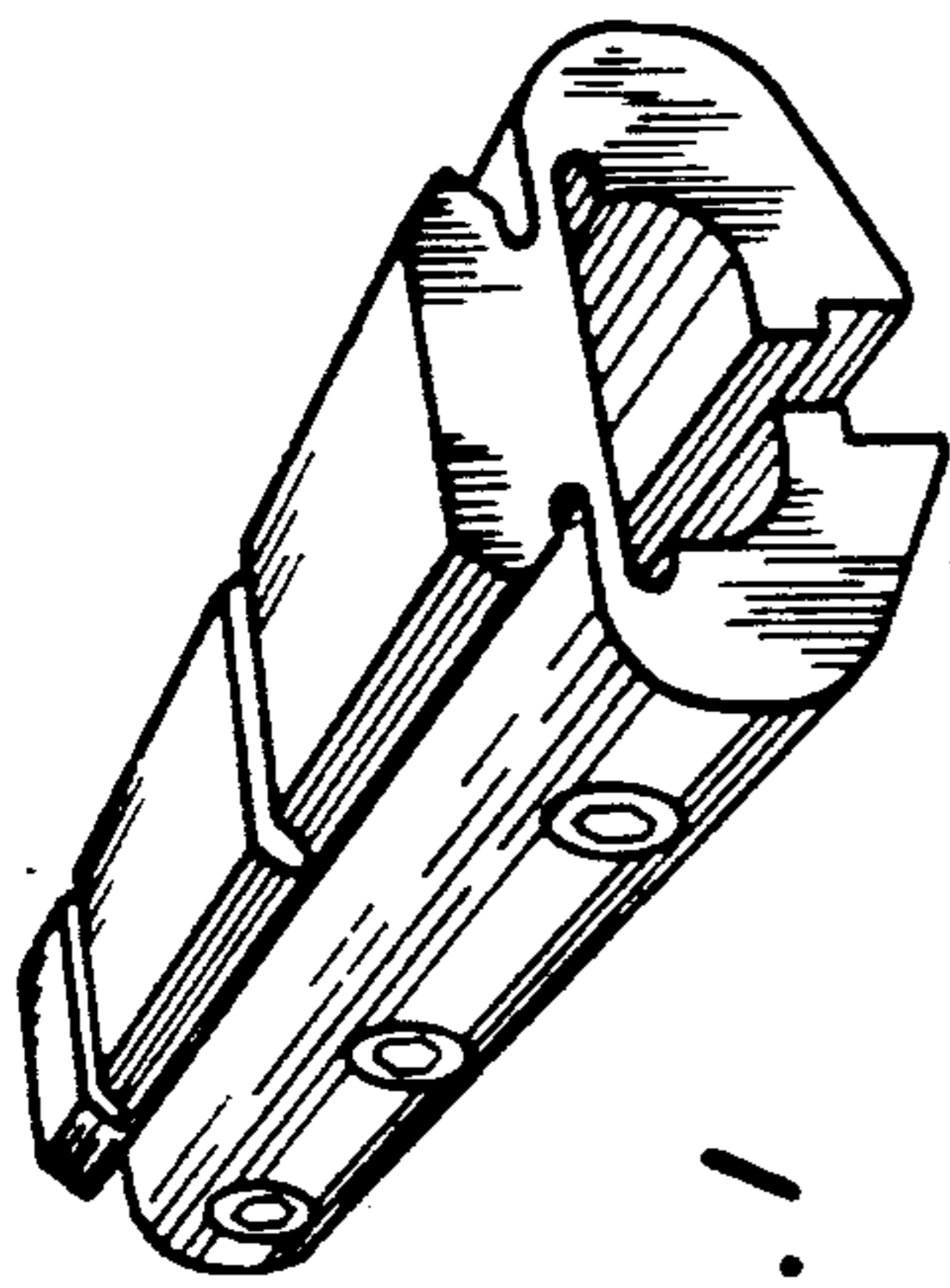

FIG. 1

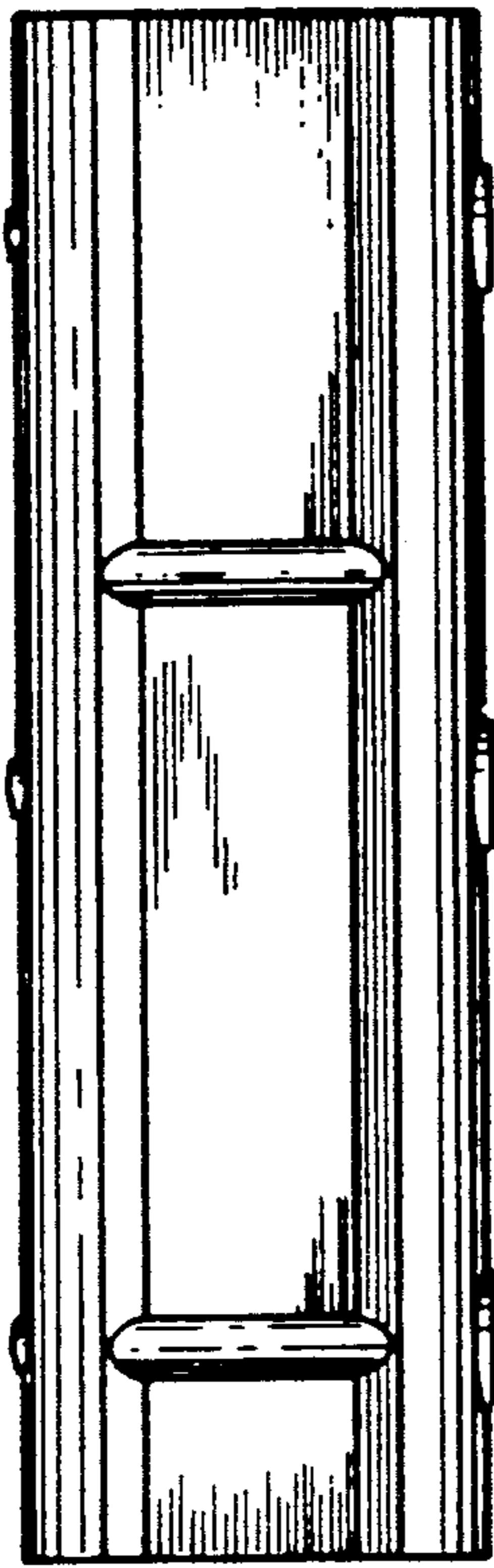

FIG. 3

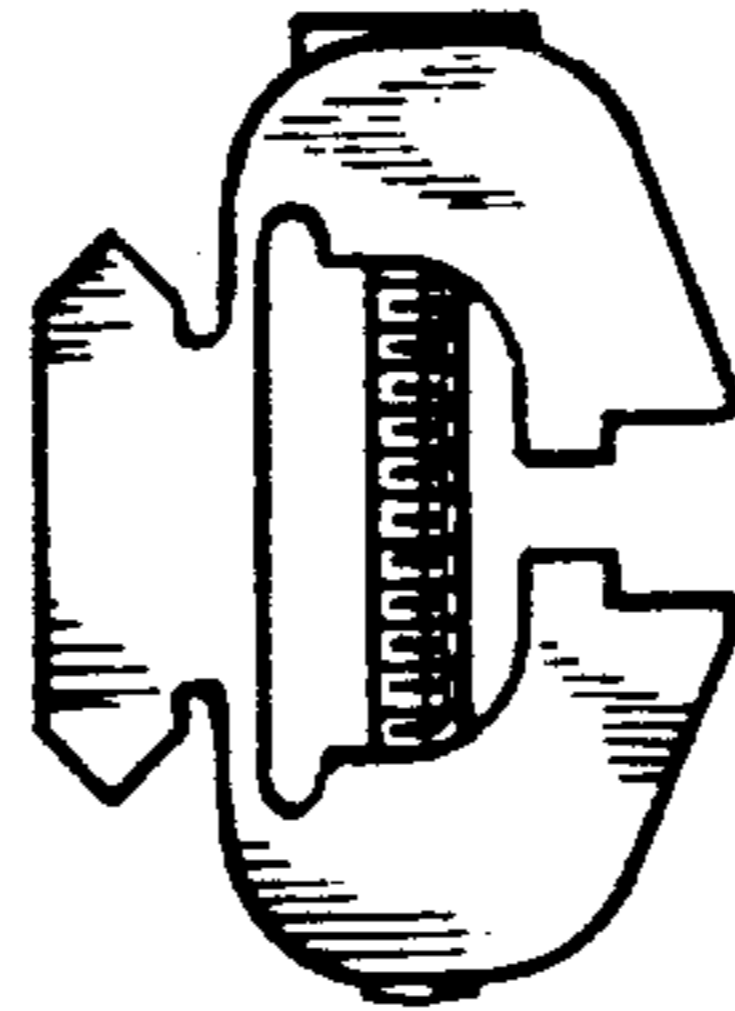

FIG. 5



FIG. 2



FIG. 6

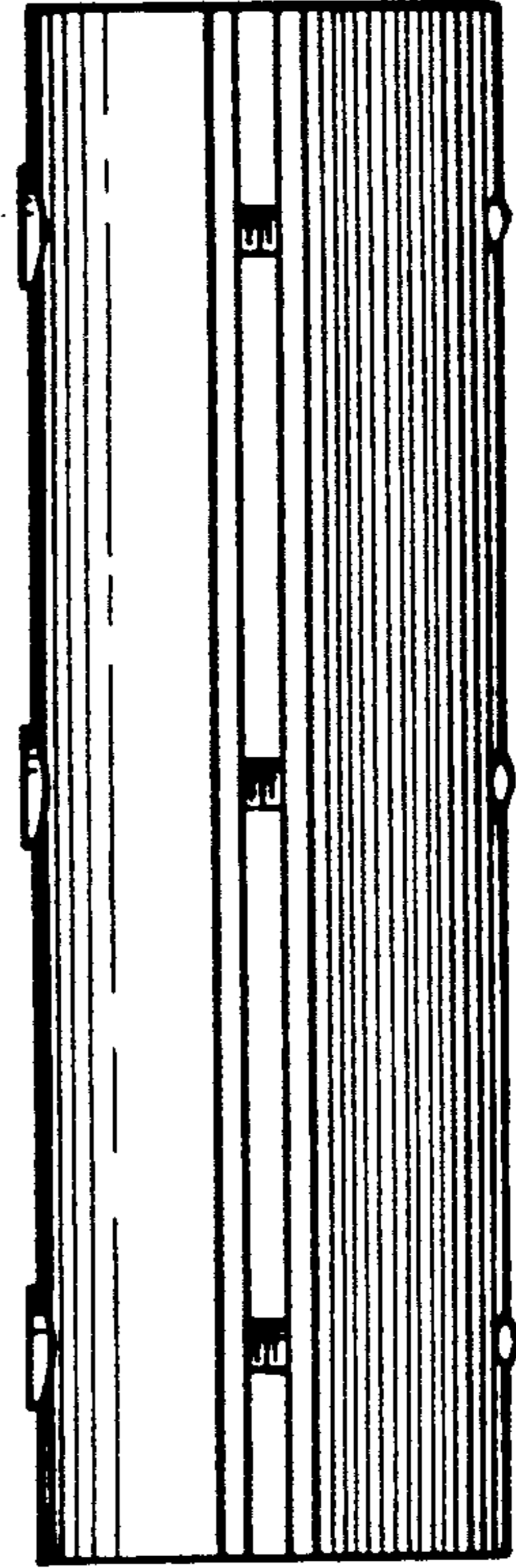

FIG. 4

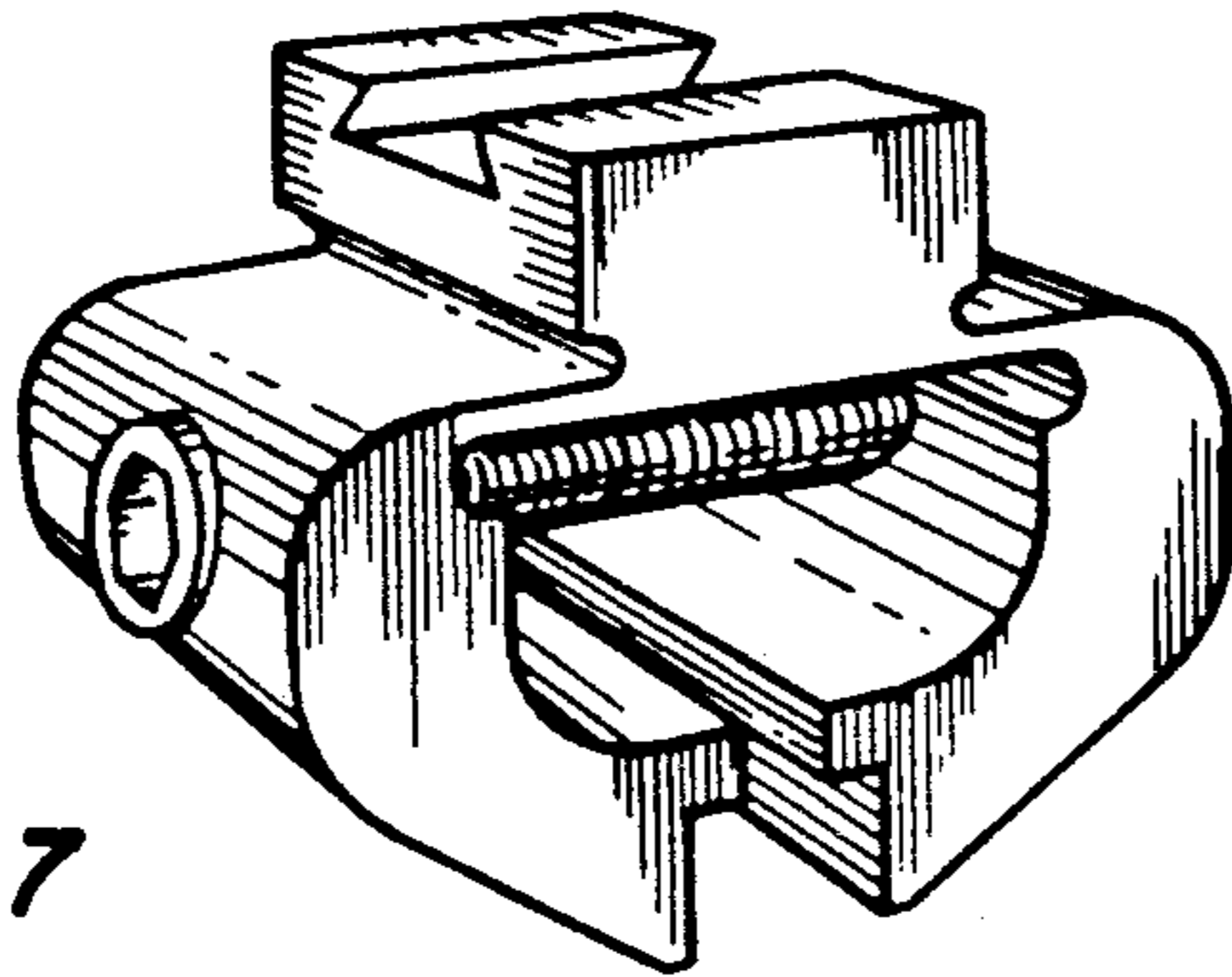

FIG. 7

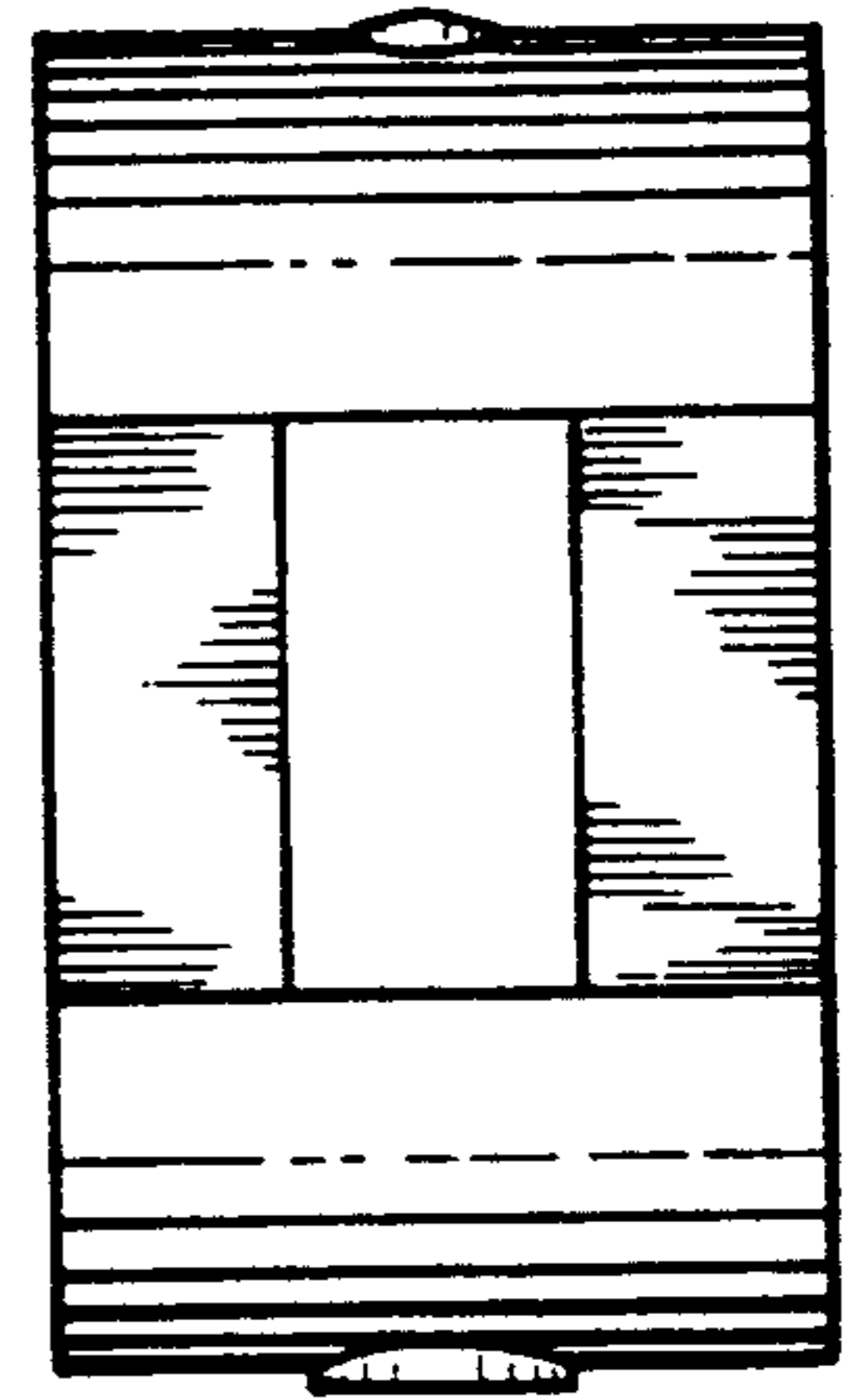

FIG. 9

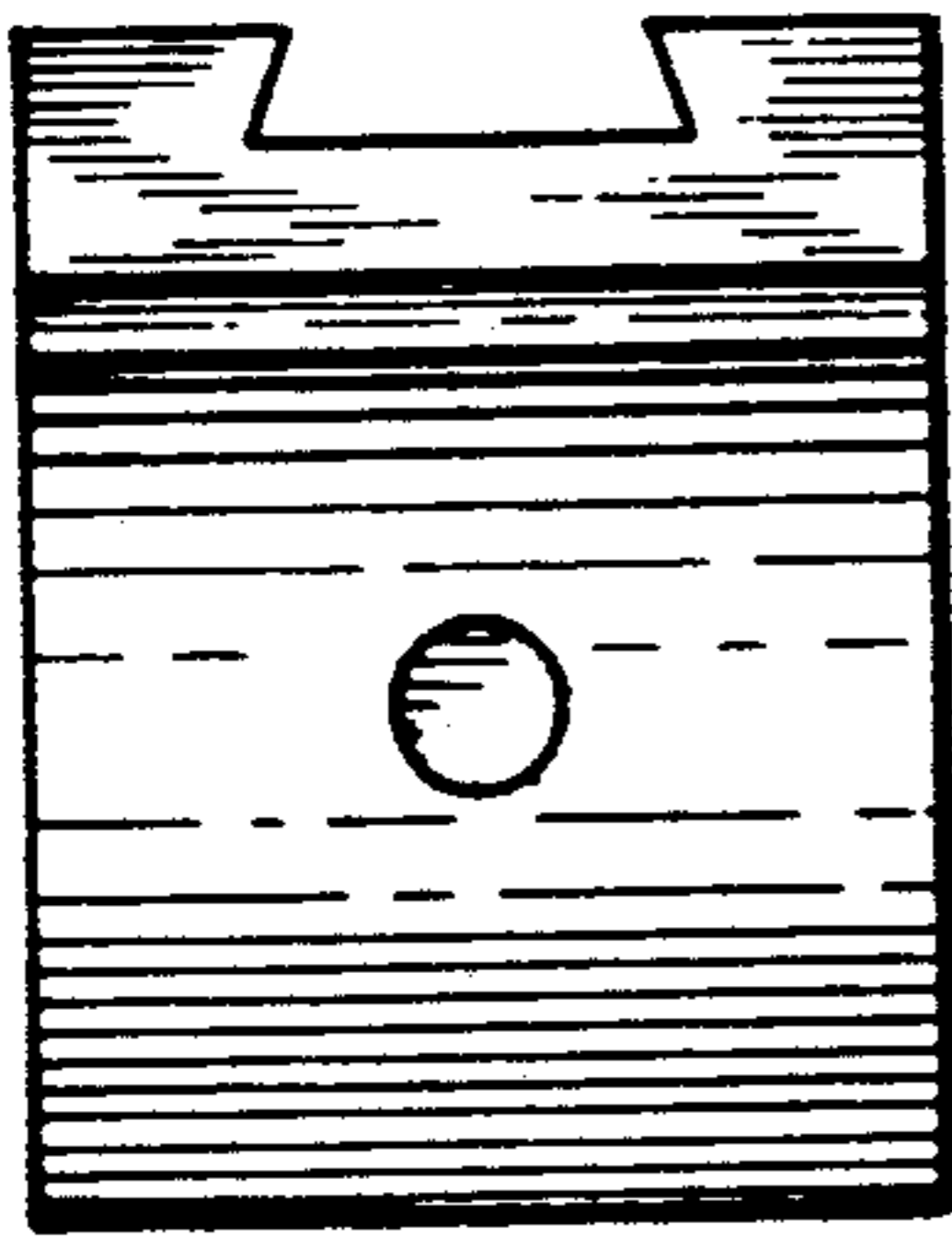

FIG. 12

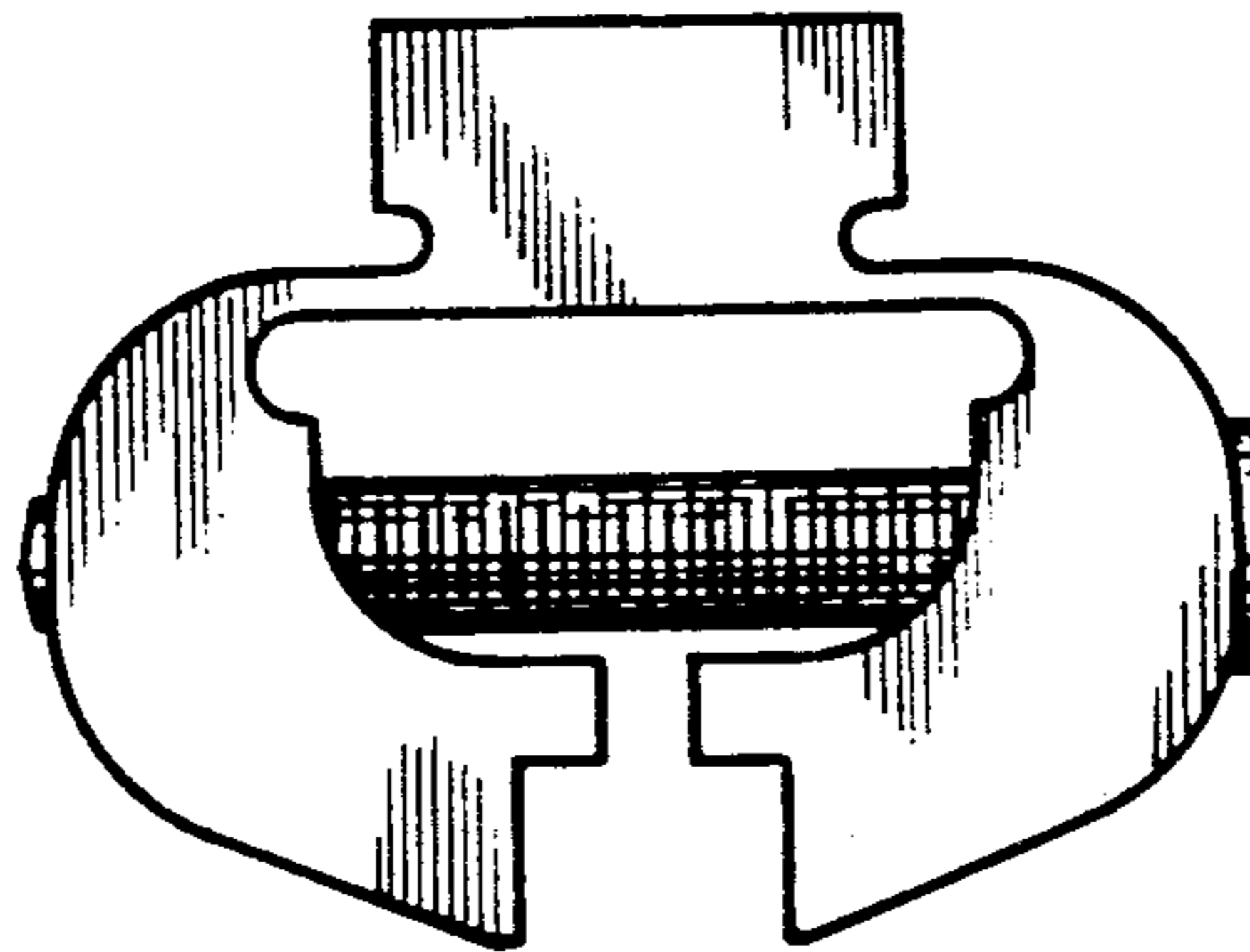

FIG. 11

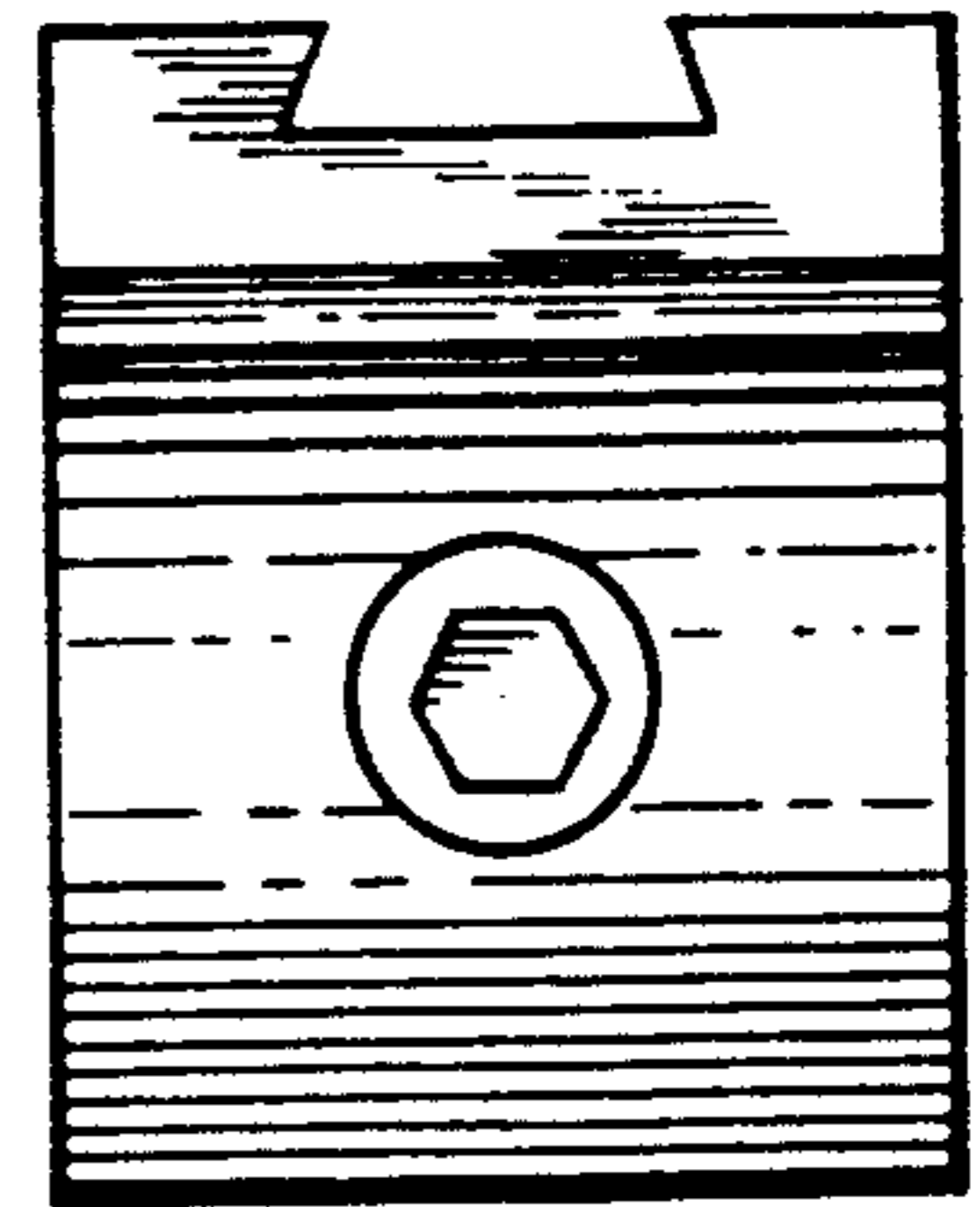

FIG. 8

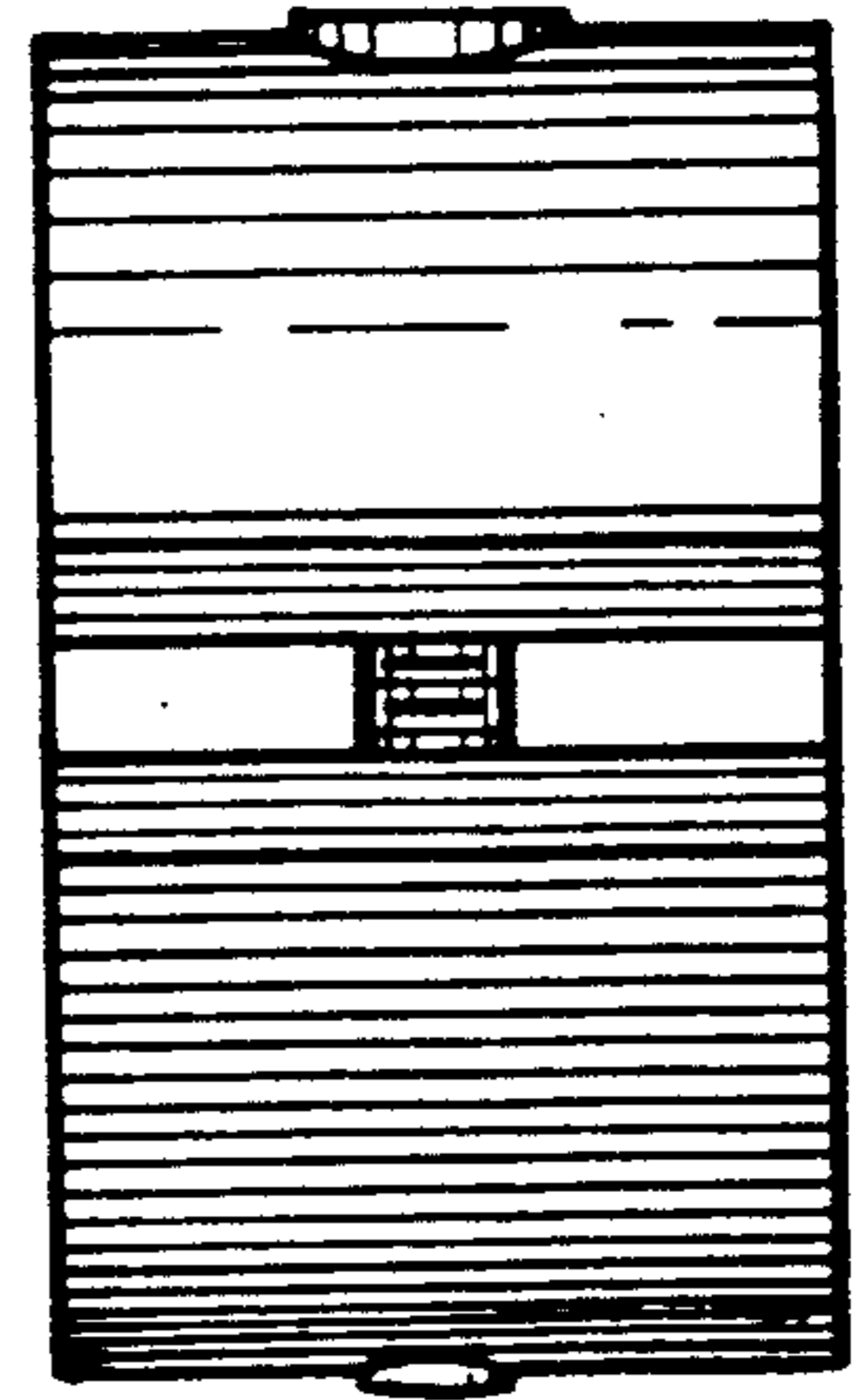

FIG. 10



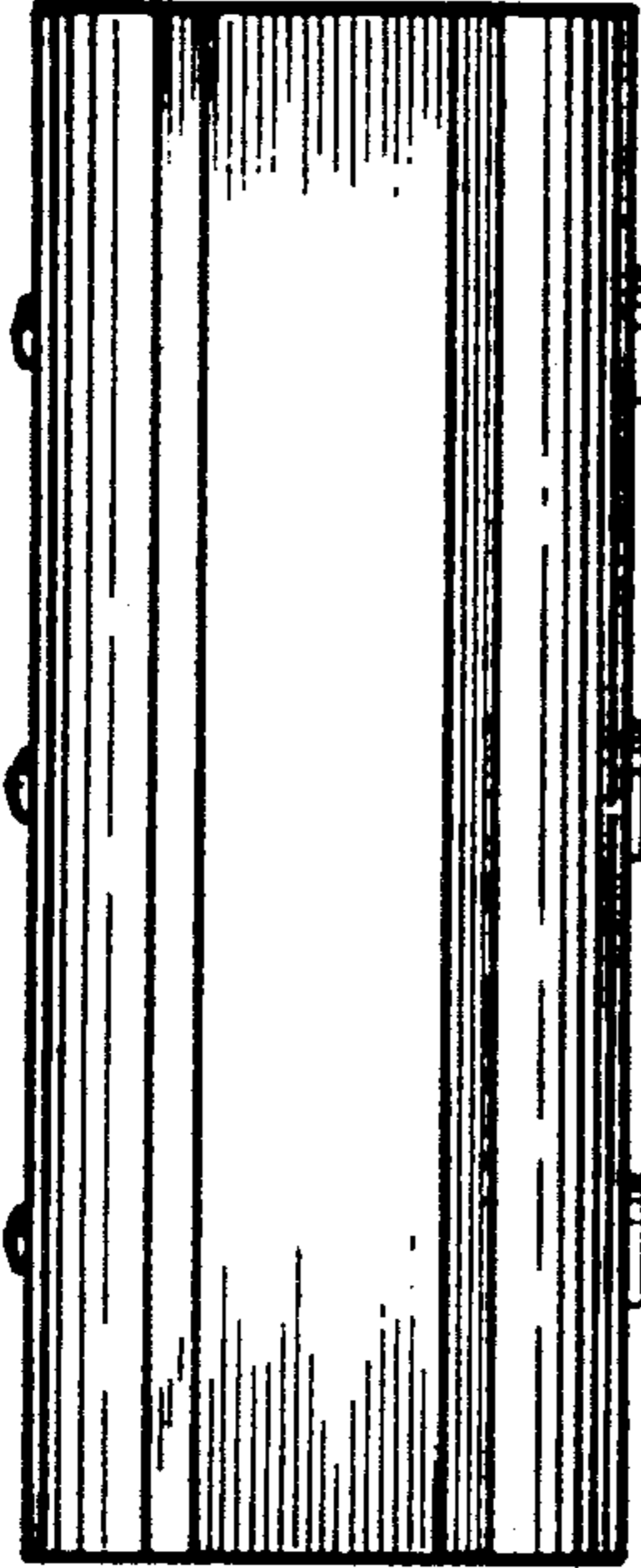

FIG. 13

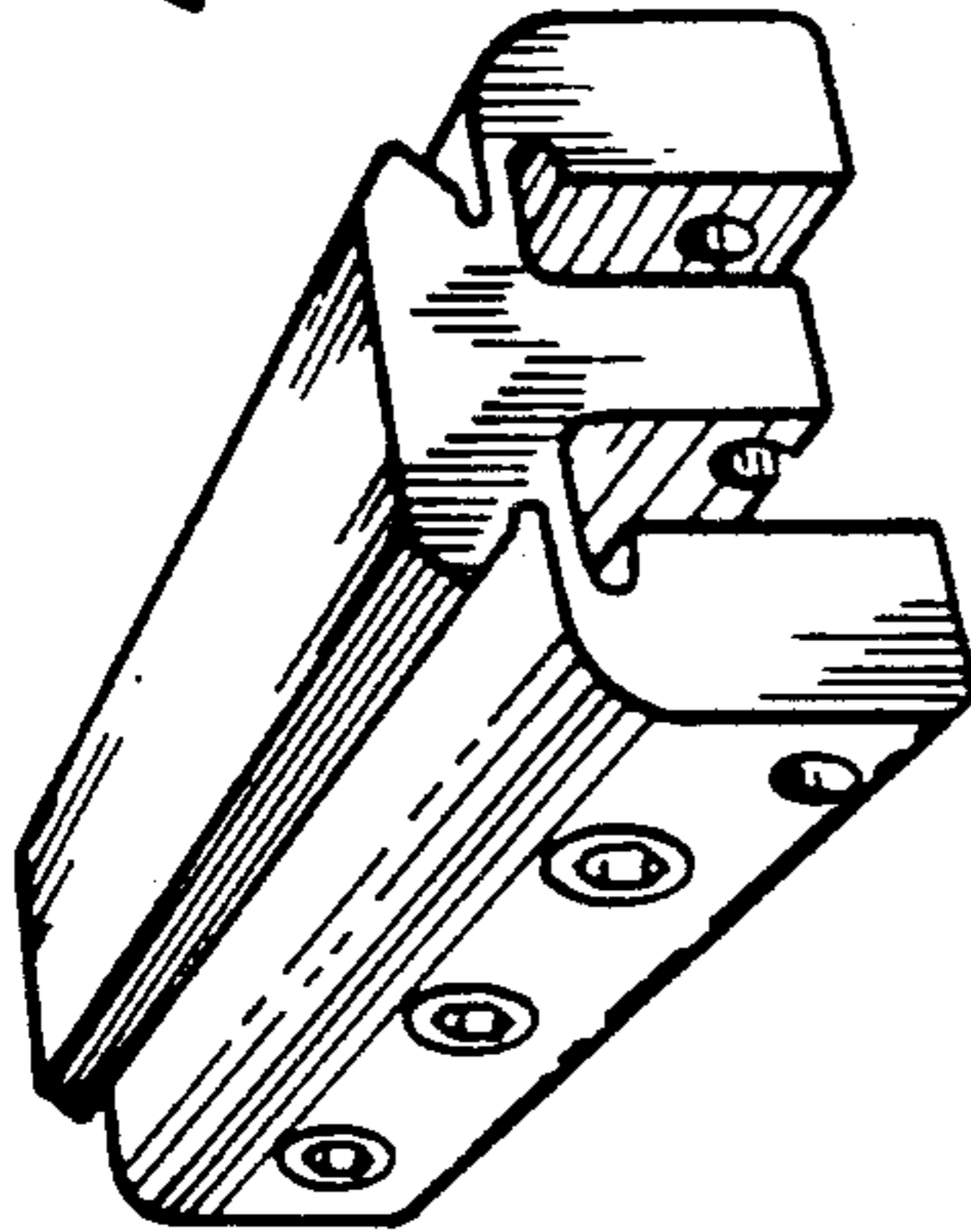

FIG. 15



FIG. 14



FIG. 16

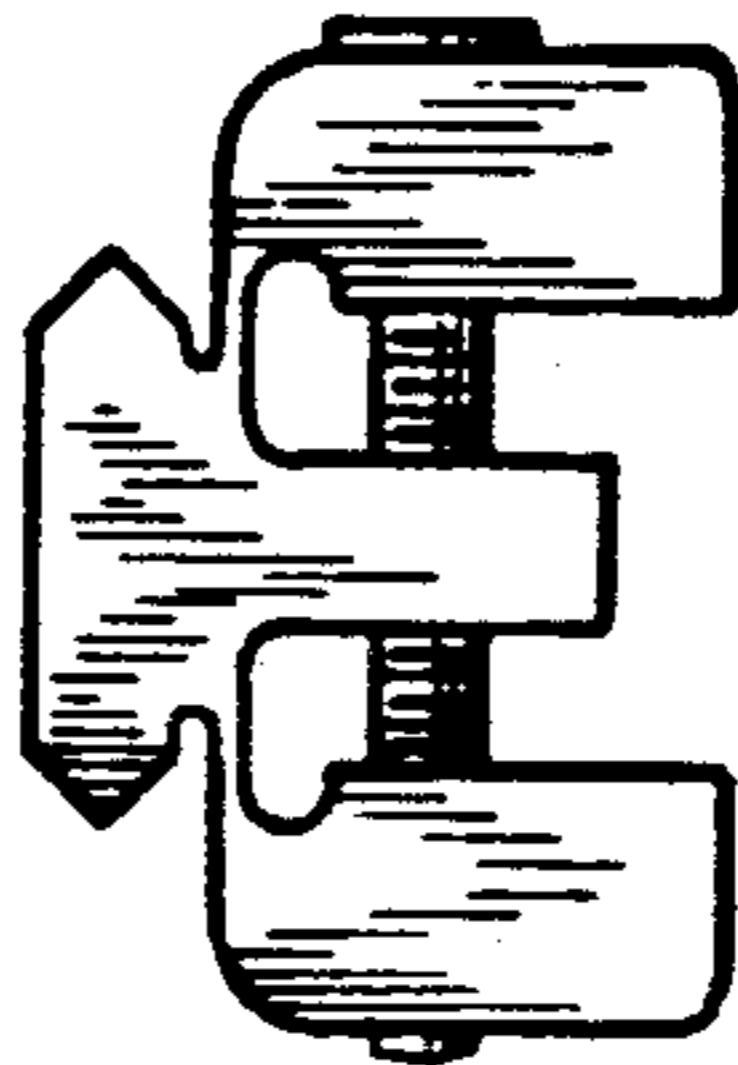

FIG. 17

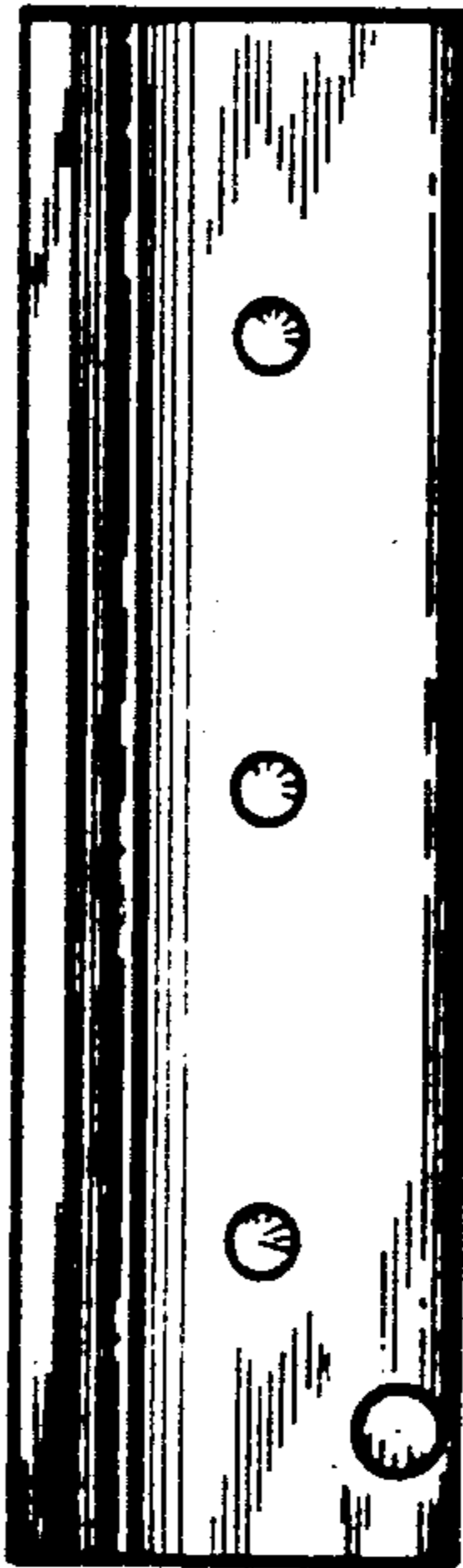

FIG. 18