

[54] GOLF CLUB HEAD

[76] Inventor: William B. Shearer, 2905 W. Main St., Muncie, Ind. 47305

[**] Term: 14 Years

[21] Appl. No.: 357,866

[22] Filed: May 30, 1989

[52] U.S. Cl. D21/219

[58] Field of Search D21/214-220; 273/164, 167-175

[56] References Cited

U.S. PATENT DOCUMENTS

D. 297,445	8/1988	Shearer	D21/219
D. 297,964	10/1988	Shearer	D21/219
D. 313,449	1/1991	Shearer	D21/219

OTHER PUBLICATIONS

Golf World, 6/3/88, p. 32, left, bottom putter.

Primary Examiner—Melvin B. Feifer
Attorney, Agent, or Firm—J. David Haynes

[57] CLAIM

The ornamental design for a golf club head, as shown.

DESCRIPTION

FIG. 1 is a perspective view of a golf club head showing my new design;
FIG. 2 is a front elevational view thereof;
FIG. 3 is a rear elevational view thereof;
FIG. 4 is an end view from the left of FIG. 2;
FIG. 5 is an end view from the right of FIG. 2;
FIG. 6 is a top plan view thereof; and
FIG. 7 is a bottom plan view thereof.

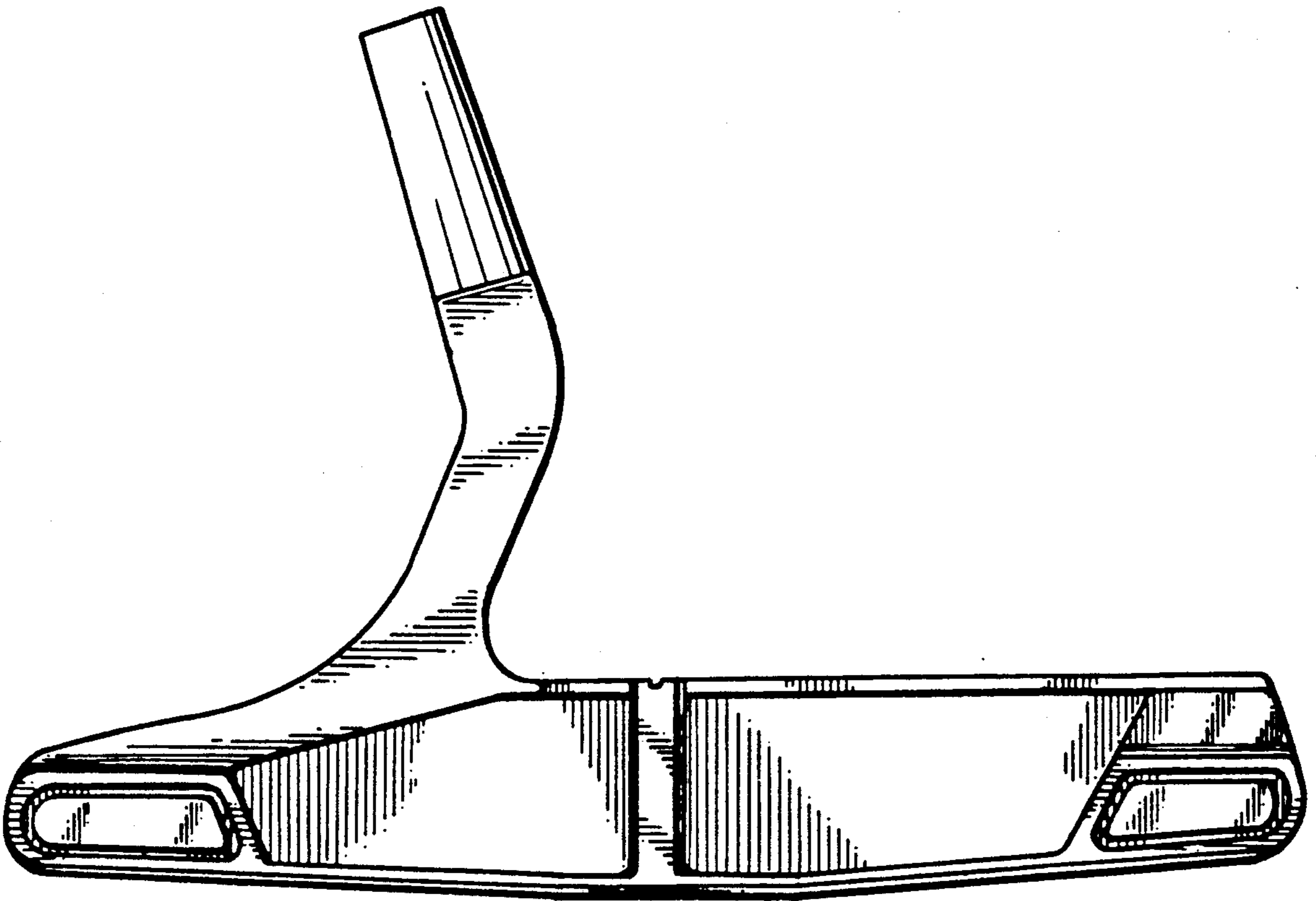

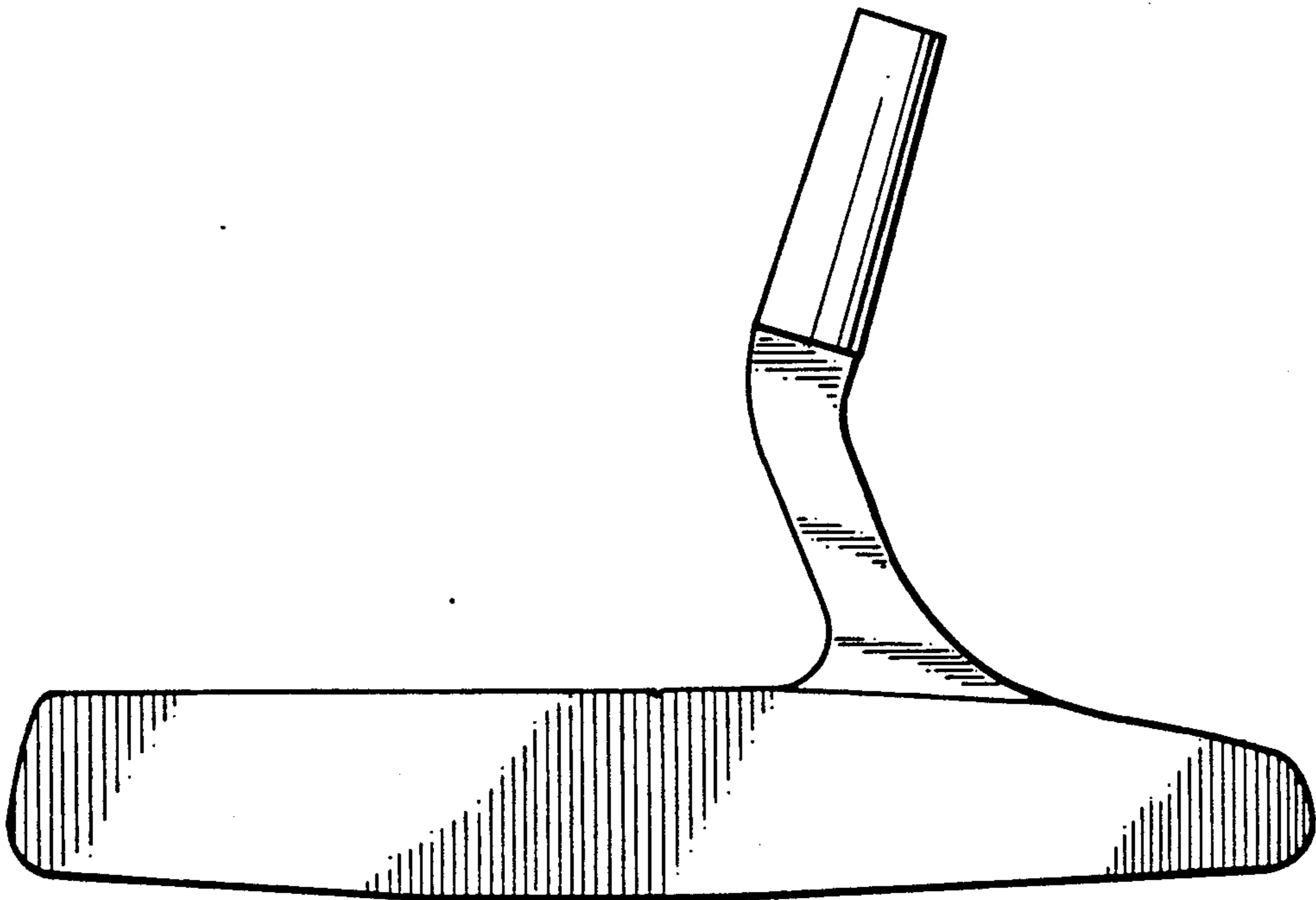
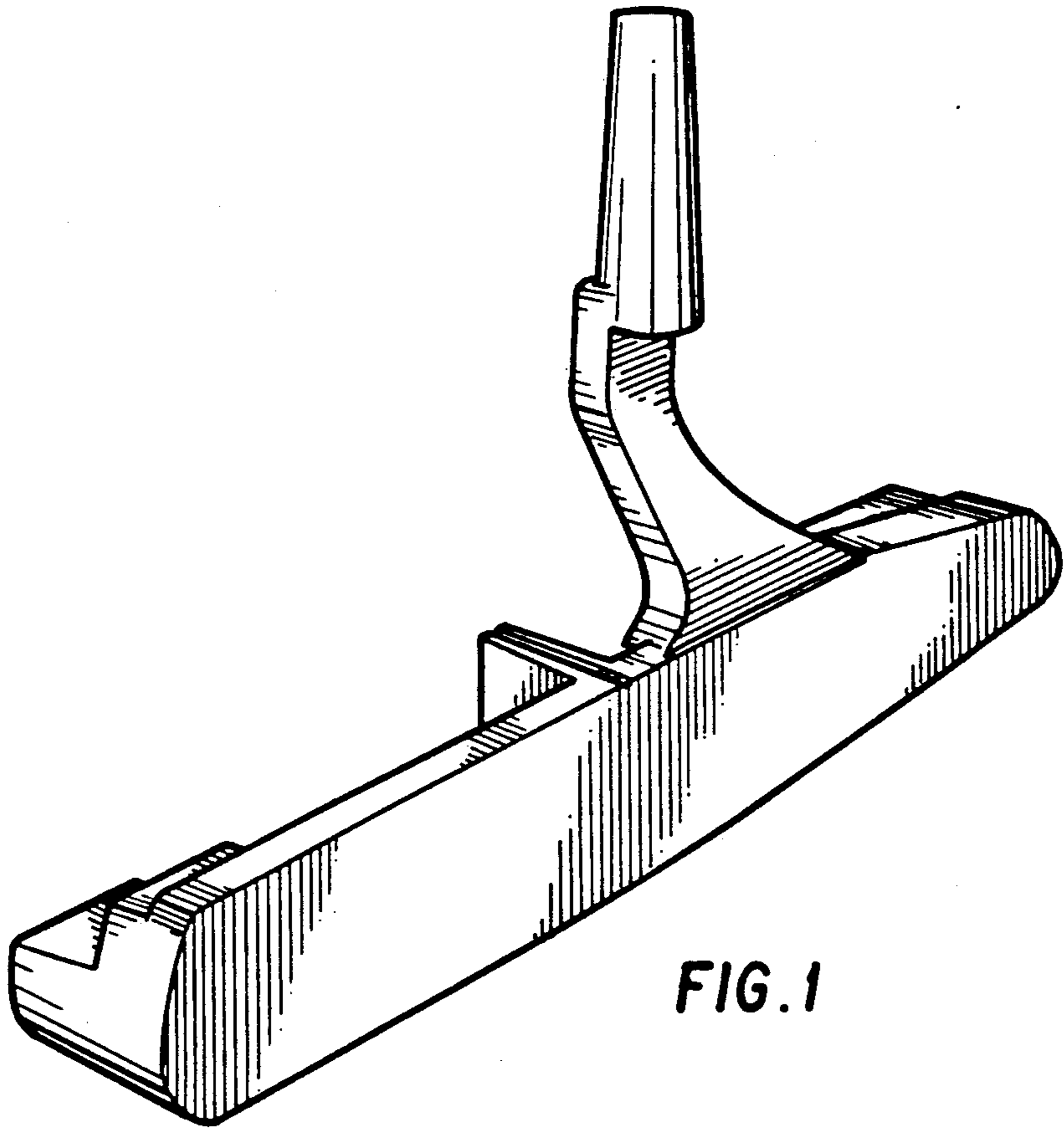

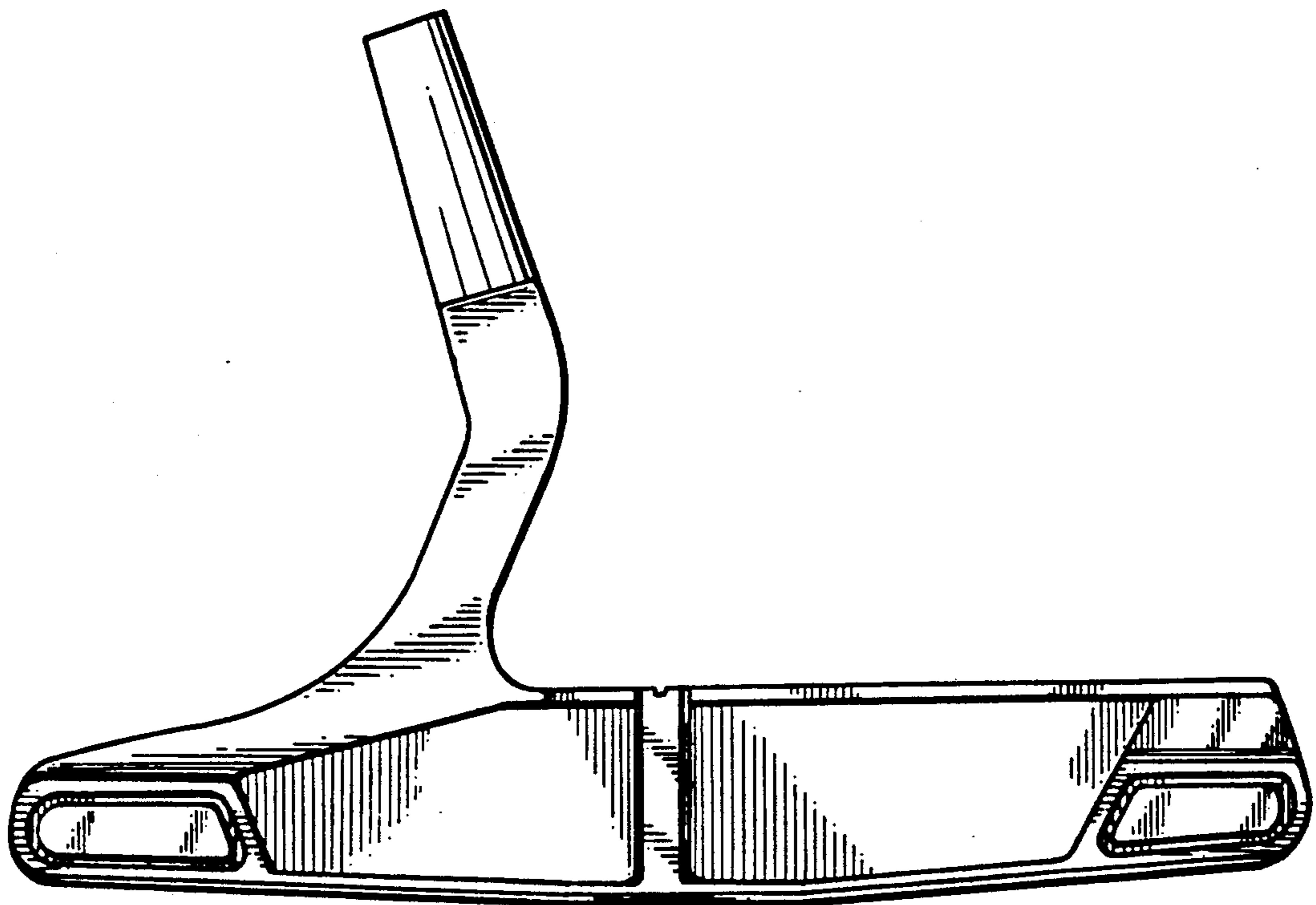

FIG. 3

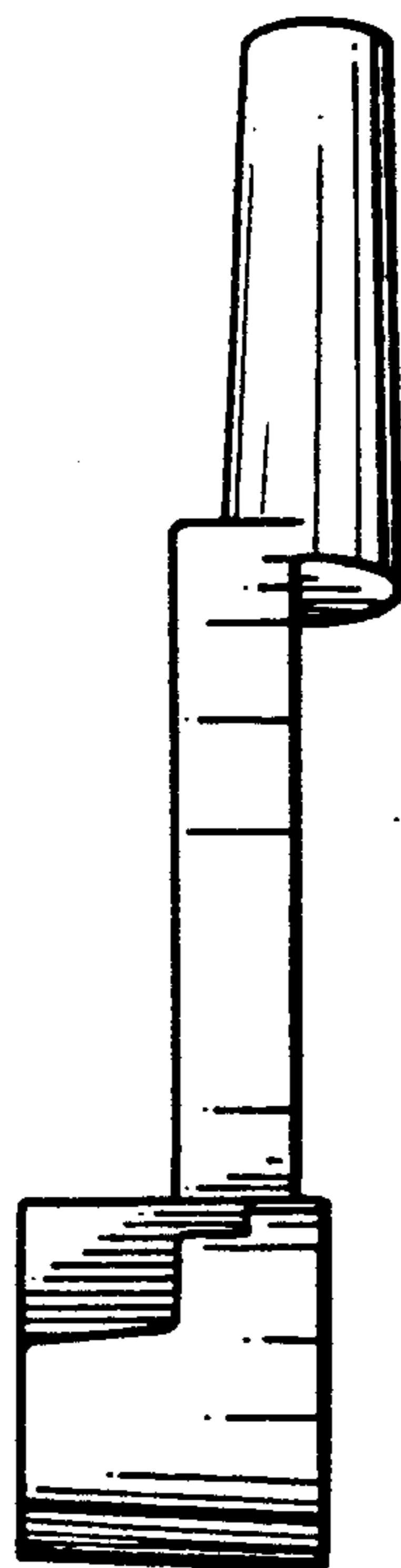

FIG. 4

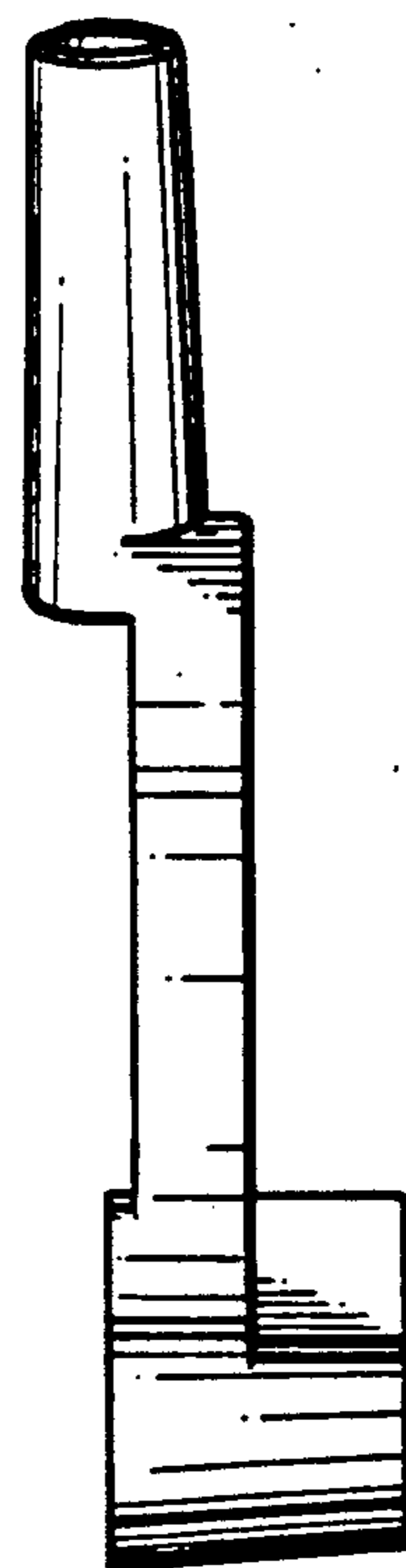

FIG. 5

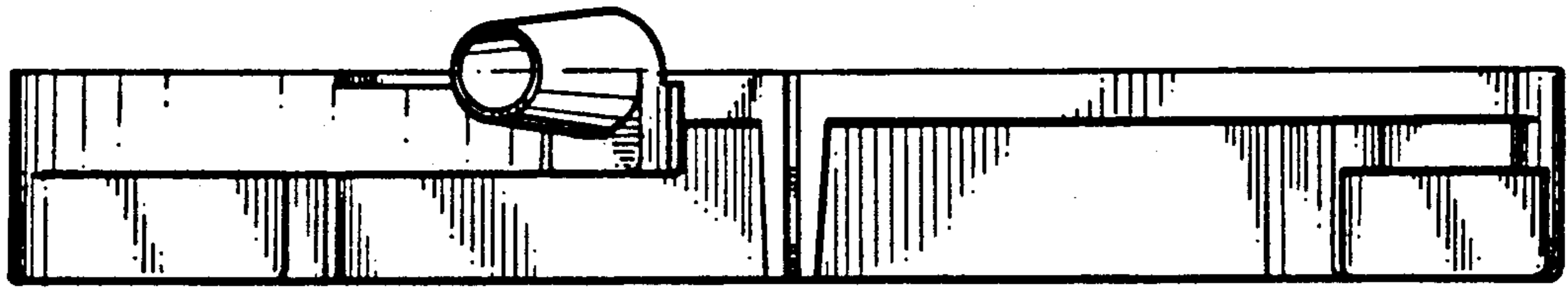

FIG. 6

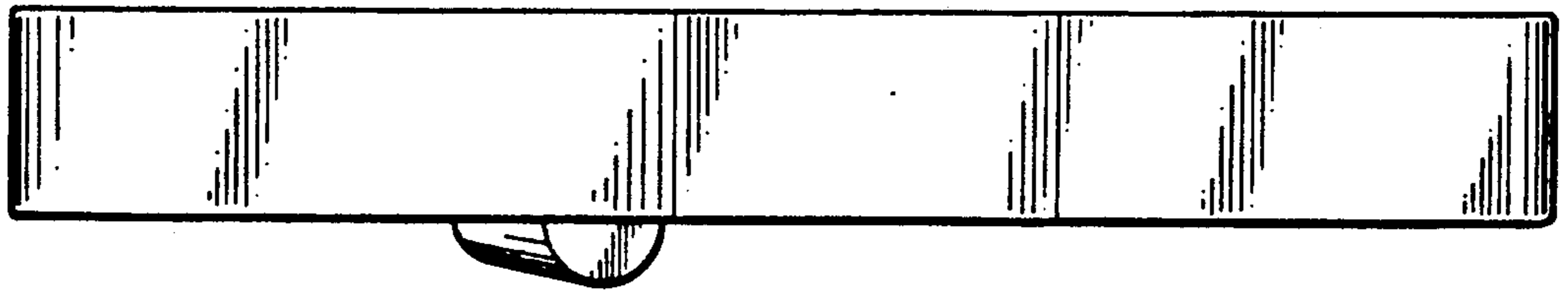

FIG. 7