

[54] DISK DRIVE UNIT FOR COMPUTER

[75] Inventors: Richard F. Sapper, Montagnola, Switzerland; Steven A. Silverstein; James P. Wang, both of Lexington, Ky.

[73] Assignee: International Business Machines Corporation, Armonk, N.Y.

[**] Term: 14 Years

[21] Appl. No.: 419,852

[22] Filed: Oct. 11, 1989

[52] U.S. Cl. D14/109

[58] Field of Search D14/100, 101, 105, 106, D14/107, 108, 109; D13/162, 184, 199; 360/97-99, 137; 361/331, 332, 380, 381, 390-395, 399, 415, 426; 312/138.1, 208

[56] References Cited

U.S. PATENT DOCUMENTS

- D. 298,252 10/1988 Sapper D14/115
- D. 301,139 5/1989 Sato et al. D14/100
- D. 307,135 4/1990 Sato et al. D14/100
- D. 307,136 4/1990 Boyer et al. D14/113

D. 307,746 5/1990 Armstrong et al. D14/109 X

Primary Examiner—James M. Gandy.
Assistant Examiner—Freda S. Nunn
Attorney, Agent, or Firm—John A. Brady

[57] CLAIM

The ornamental design for a disk drive unit for computer, as shown and described.

DESCRIPTION

FIG. 1 is a front elevational view of a disk drive unit for computer showing our new design;
 FIG. 2 is a top plan view thereof;
 FIG. 3 is a right side elevational view thereof;
 FIG. 4 is a left side elevational view thereof;
 FIG. 5 is a rear elevational view thereof;
 FIG. 6 is a bottom plan view thereof;
 FIG. 7 is a top, front, right side perspective view thereof on a slightly reduced scale;
 FIG. 8 is a front elevational view of a second embodiment of our design;
 FIG. 9 is a top, front, right side perspective view thereof on a slightly reduced scale.
 The undisclosed views of the second embodiment are identical in appearance to those of a first embodiment except for the addition of the second disk drive.

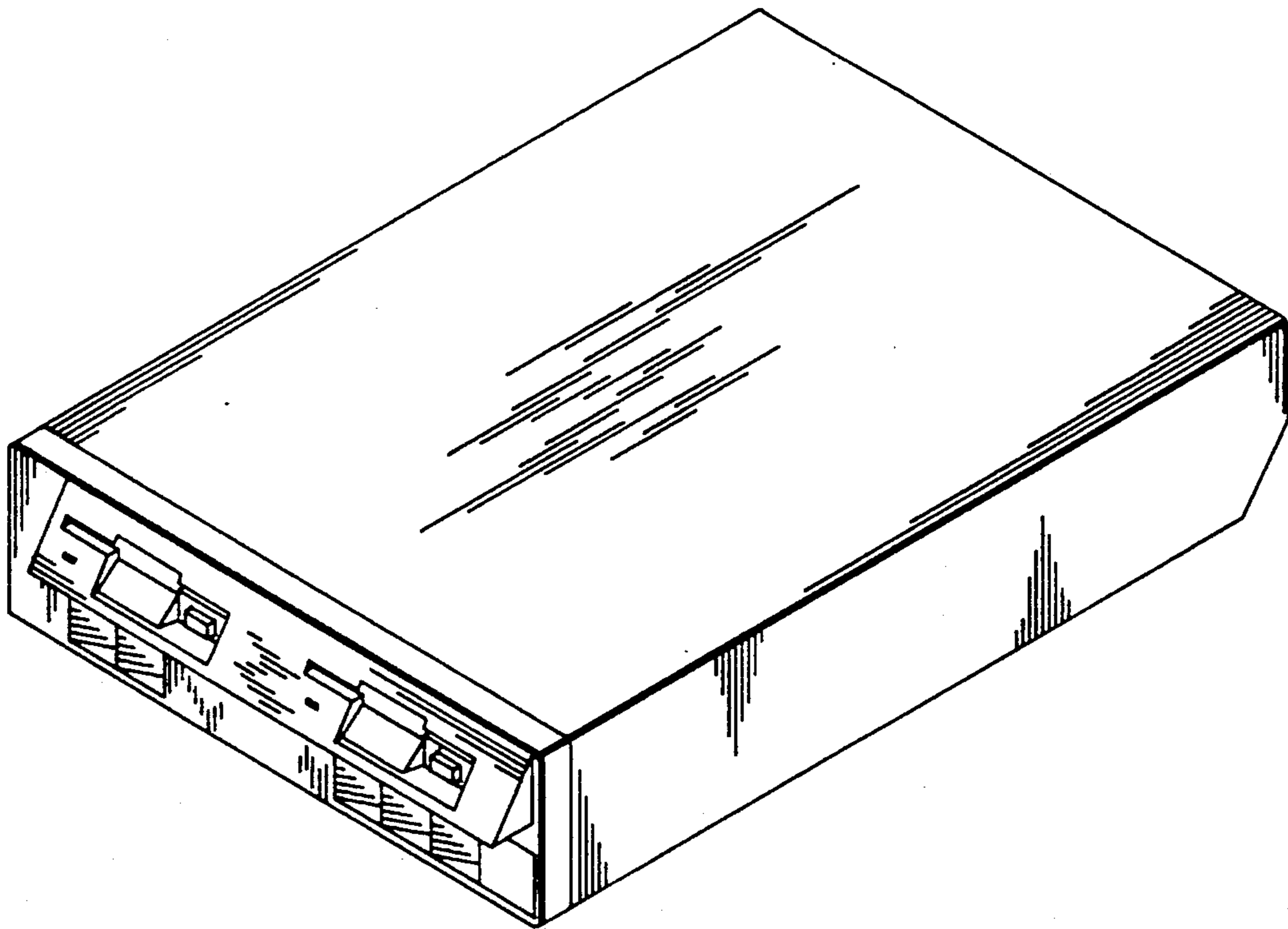

FIG. 1

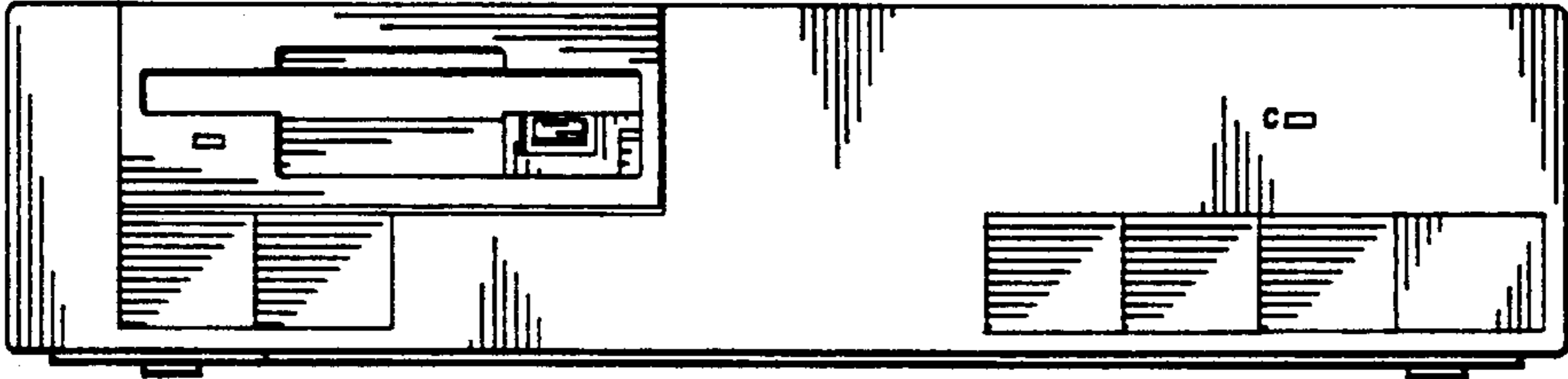

FIG. 5

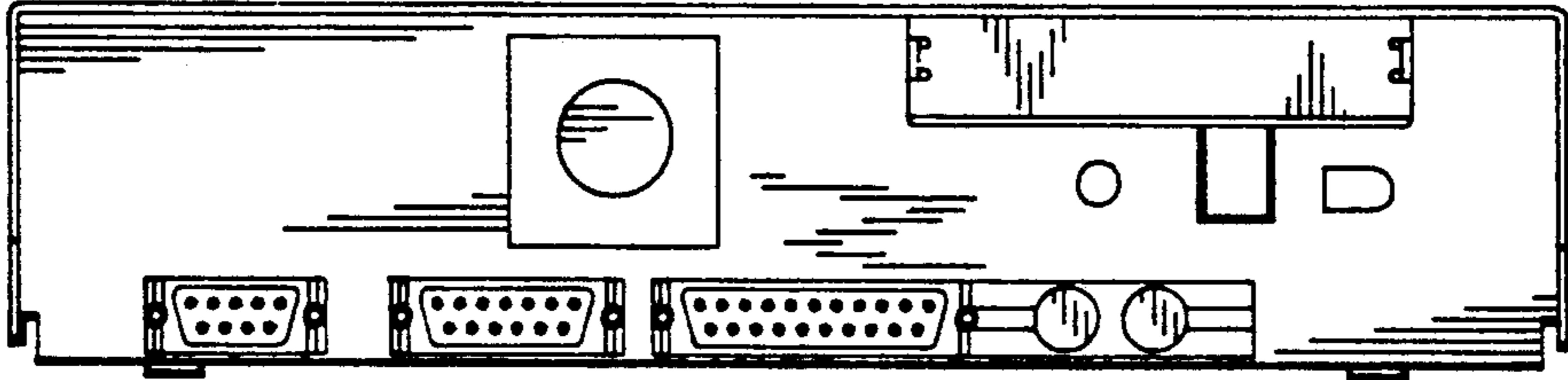

FIG. 2

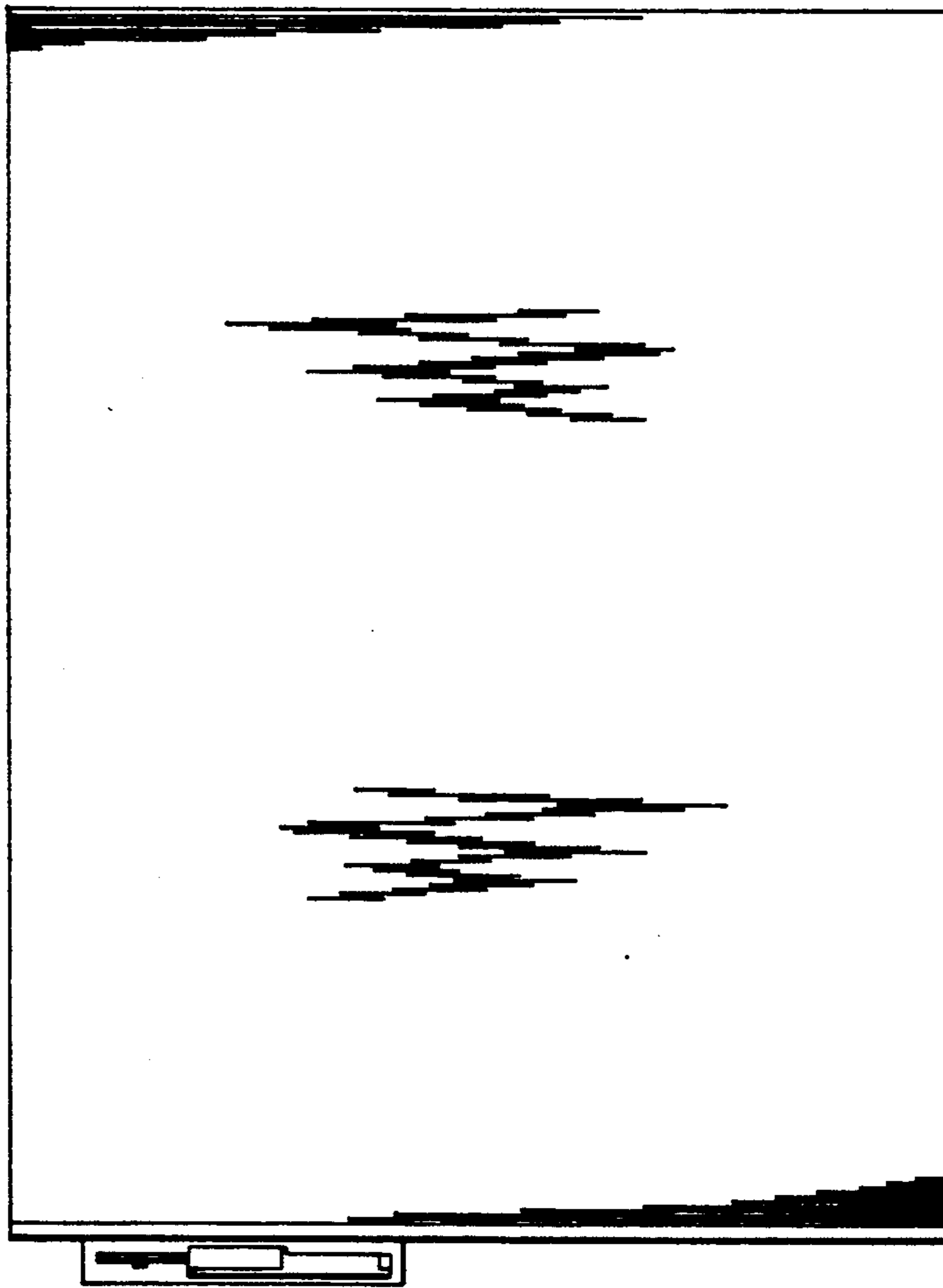

FIG. 3

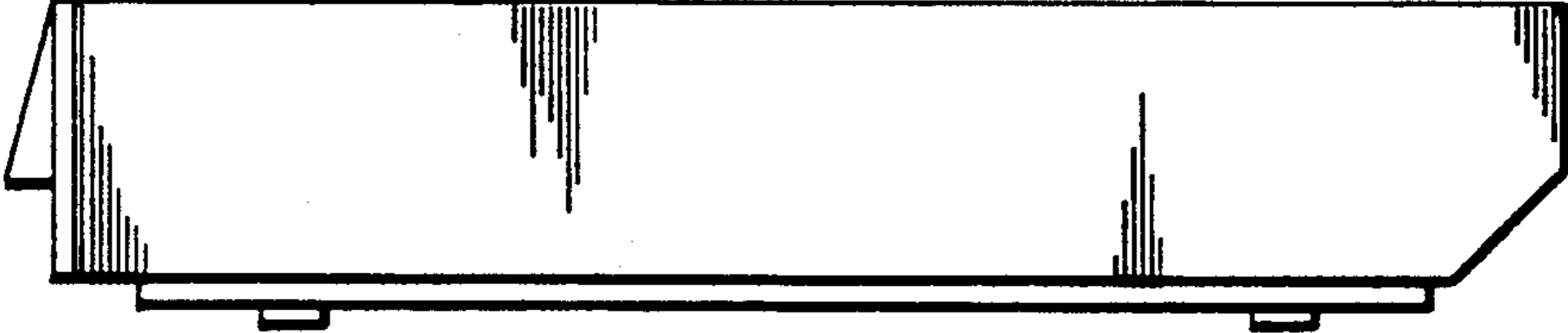

FIG. 4

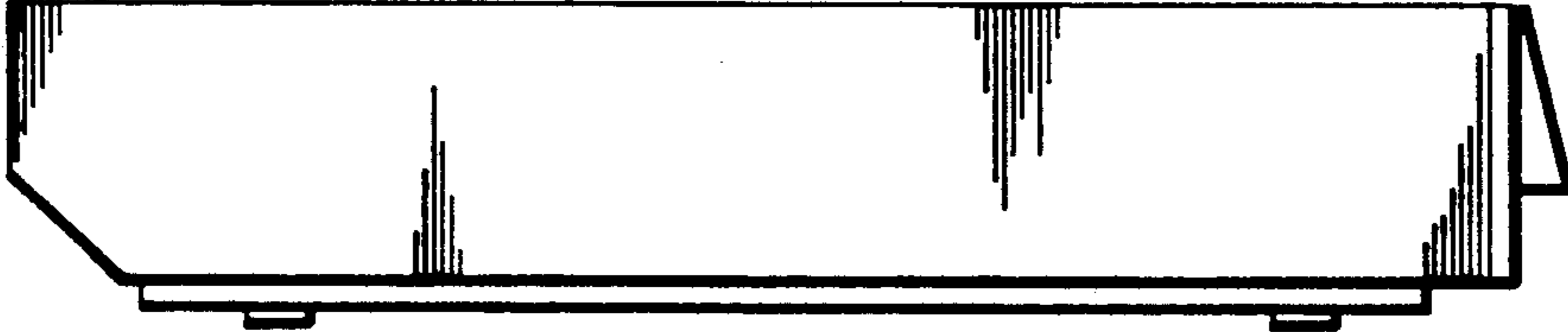

FIG. 6

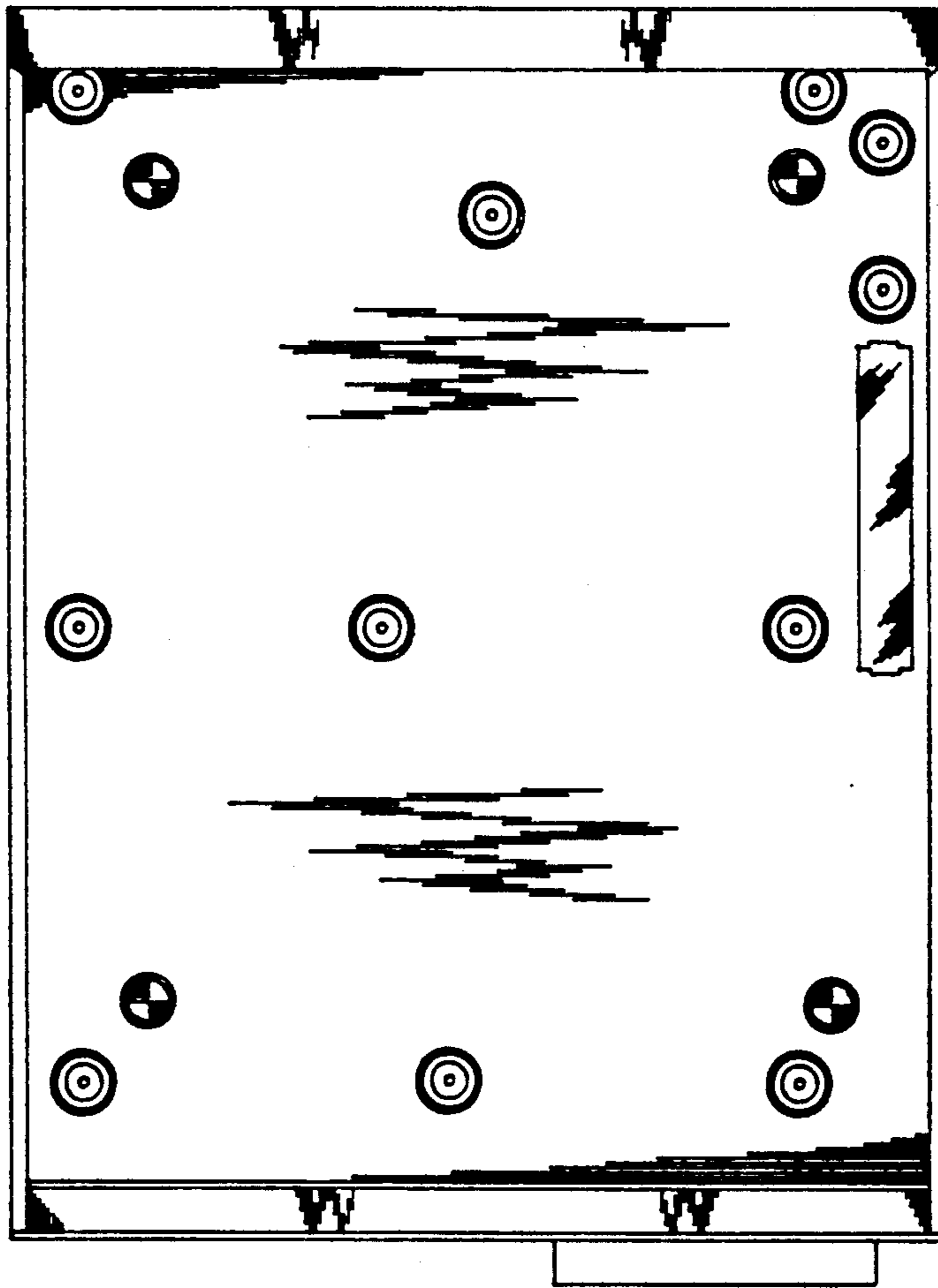

FIG. 7

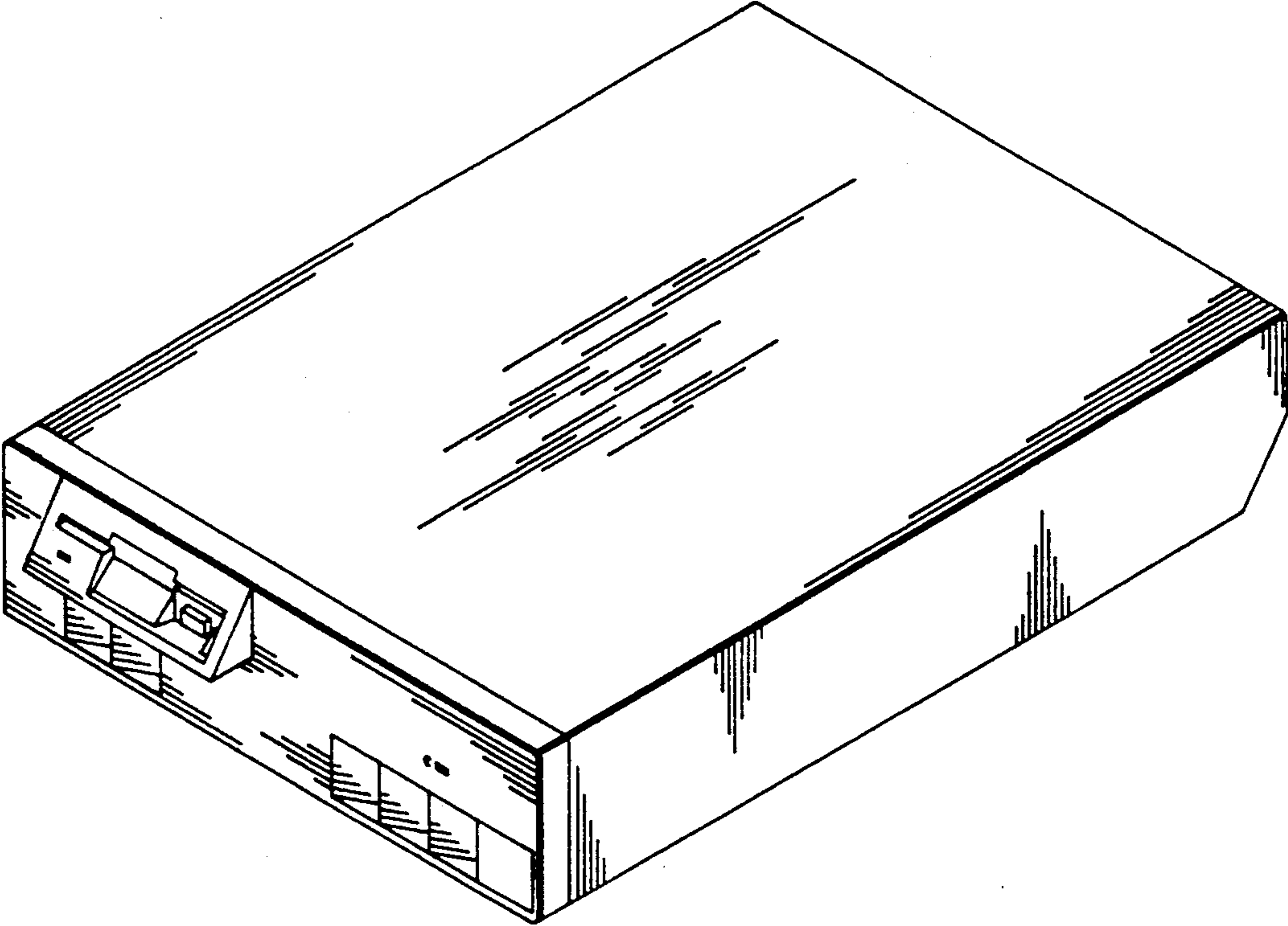

FIG. 8

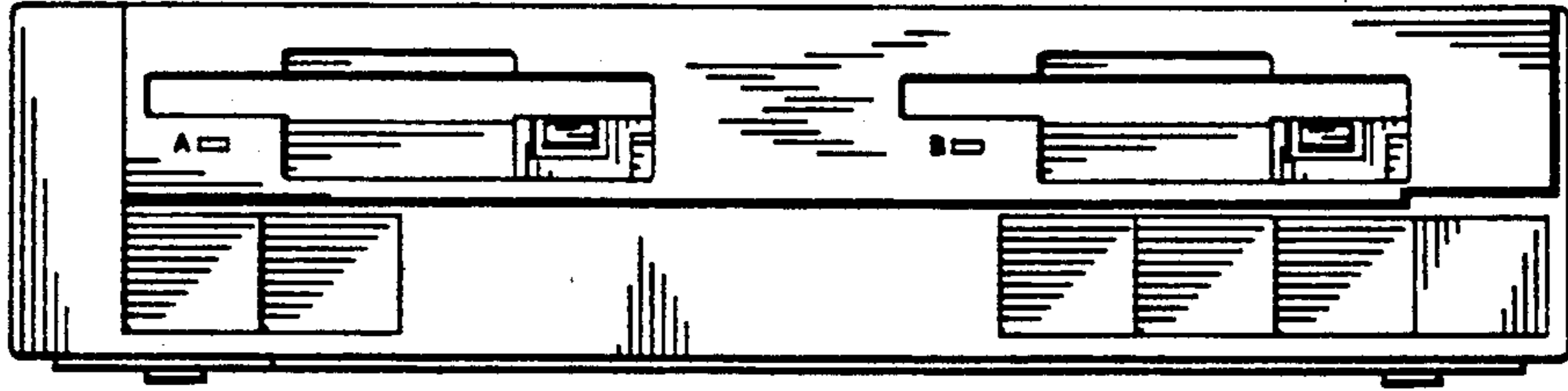

FIG. 9

