

[54] STREAMING CASSETTE TAPE DRIVE

[75] Inventors: Masafumi Ito, Tokyo; Shigeru Hasegawa, Kodaira; Minoru Sube, Hachioji; Katsuhiko Takashima, Yokohama; Keiji Tsunoda, Kokubunji, all of Japan

[73] Assignee: TEAC Corporation, Japan

[**] Term: 14 Years

[21] Appl. No.: 448,565

[22] Filed: Dec. 11, 1989

[30] Foreign Application Priority Data

Jun. 14, 1989 [JP] Japan 1-21990

[52] U.S. Cl. D14/108

[58] Field of Search D14/100-117, D14/135, 161, 164; D13/162, 184, 199; 340/711; 200/5 A, 5 R, 6 A, 6 R; 360/97.01-99.12; 361/330, 331, 334, 335, 332, 380, 381, 379, 390-395; 312/208, 253, 270, 299; 174/50, 52.1; D6/509-512

[56] References Cited

U.S. PATENT DOCUMENTS

D. 265,091	6/1982	Hutcheson	D14/107
D. 280,624	9/1985	Swan et al.	D14/109
D. 290,844	7/1987	Shibuya et al.	D14/109
D. 308,515	6/1990	Stead	D14/100
D. 314,562	2/1991	Ito et al.	D14/108

FOREIGN PATENT DOCUMENTS

739982 8/1988 Japan .

Primary Examiner—Wallace R. Burke

Assistant Examiner—Freda S. Nunn

Attorney, Agent, or Firm—Andrus, Scales, Starke & Sawall

[57] CLAIM

The ornamental design for a steaming cassette tape drive, as shown and described.

DESCRIPTION

FIG. 1 is a front elevational view of a streaming cassette tape drive showing our new design; FIG. 2 is a rear elevational view thereof; FIG. 3 is a left side elevational view thereof; FIG. 4 is a right side elevational view thereof; FIG. 5 is a top plan view thereof; FIG. 6 is a bottom plan view thereof; FIG. 7 is a top front right side perspective view thereof.

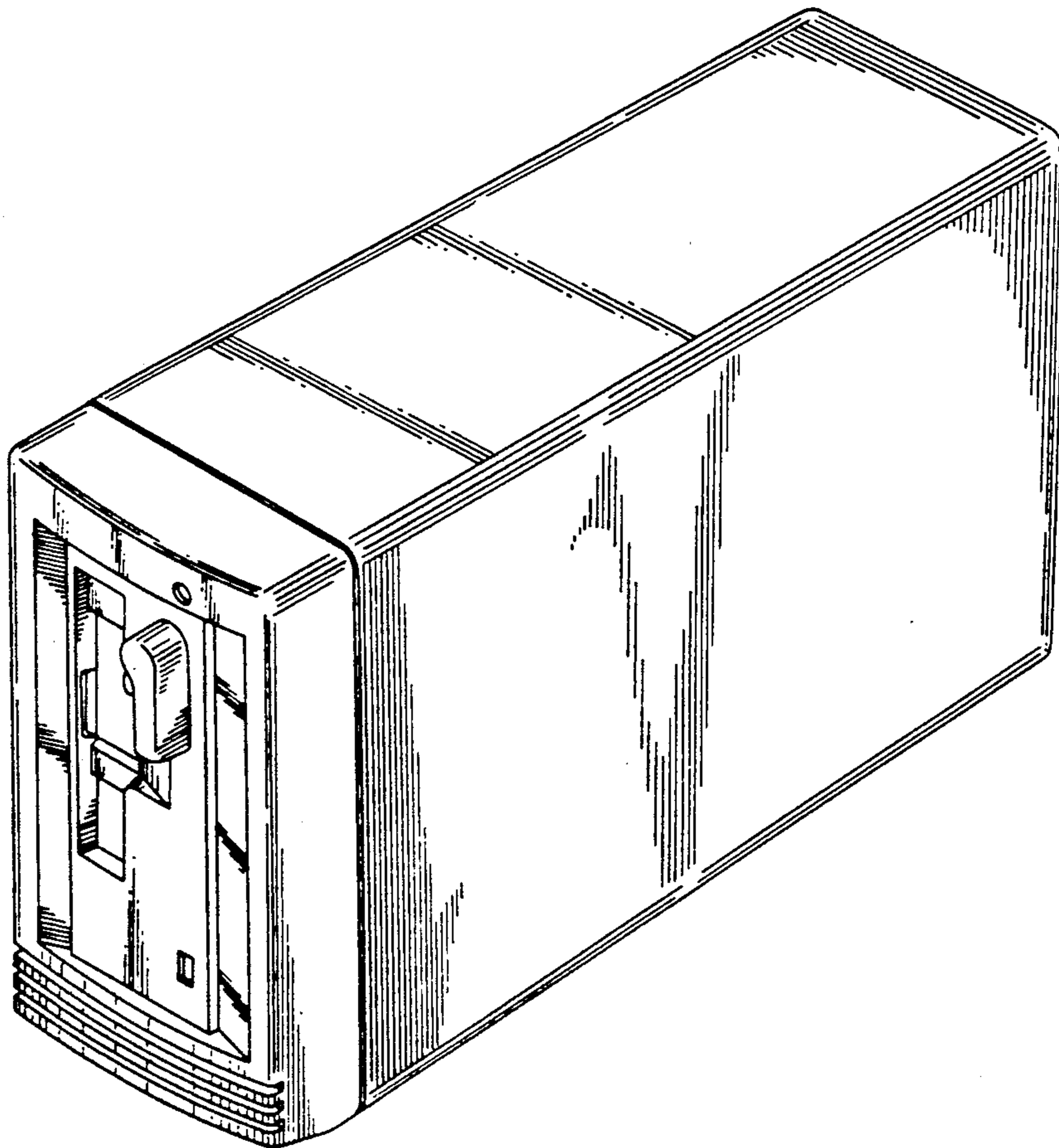

FIG. 1

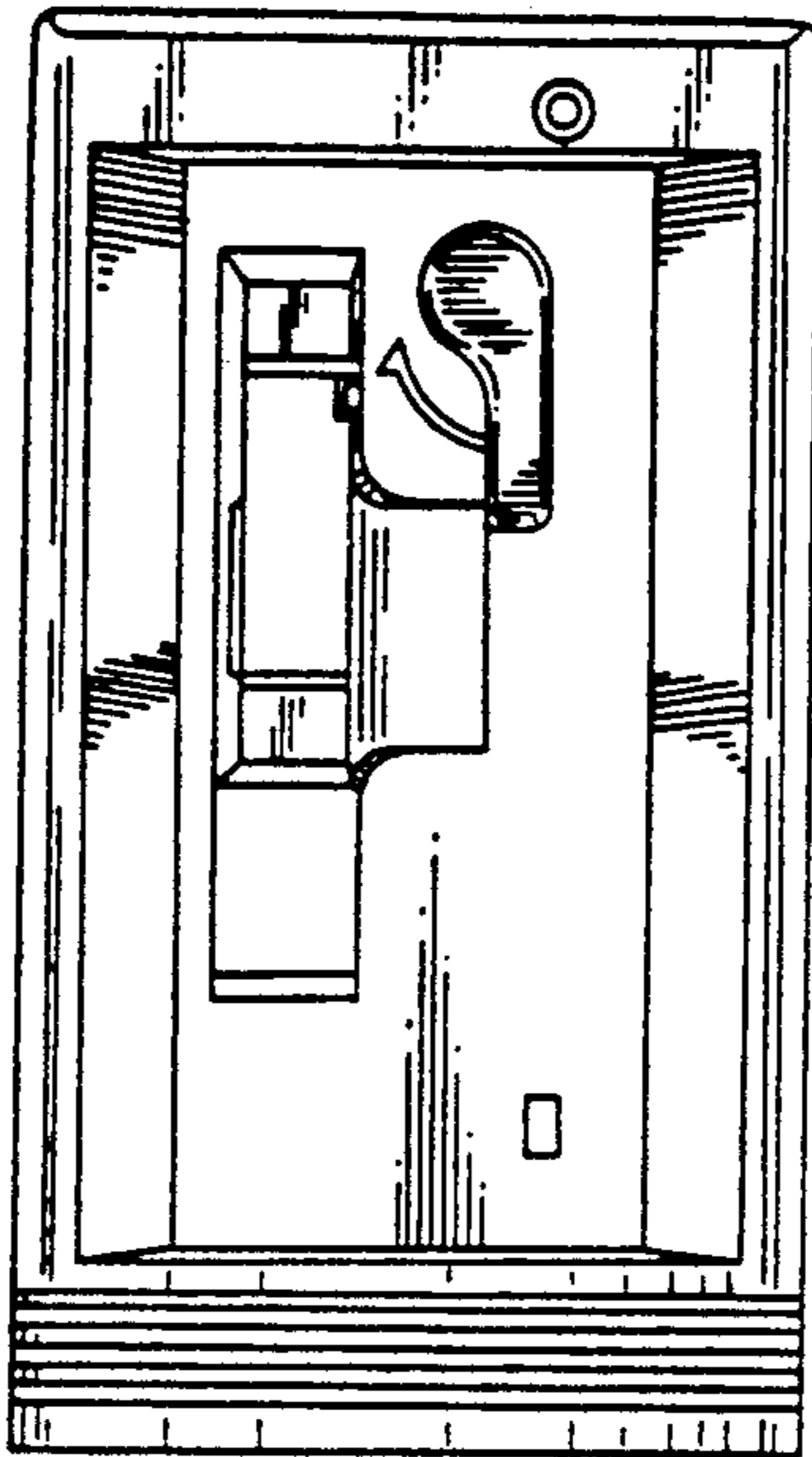

FIG. 2

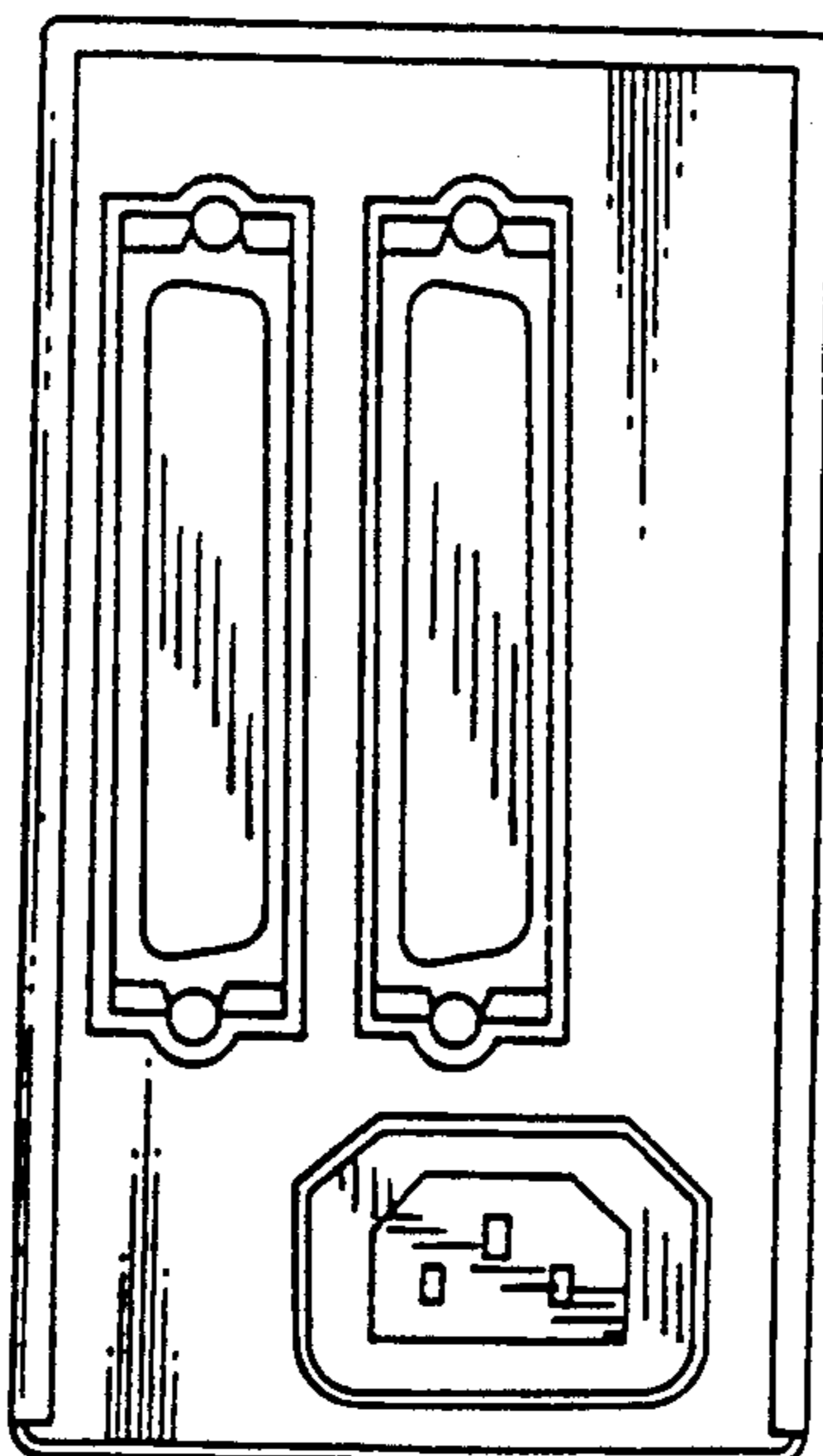

FIG. 3

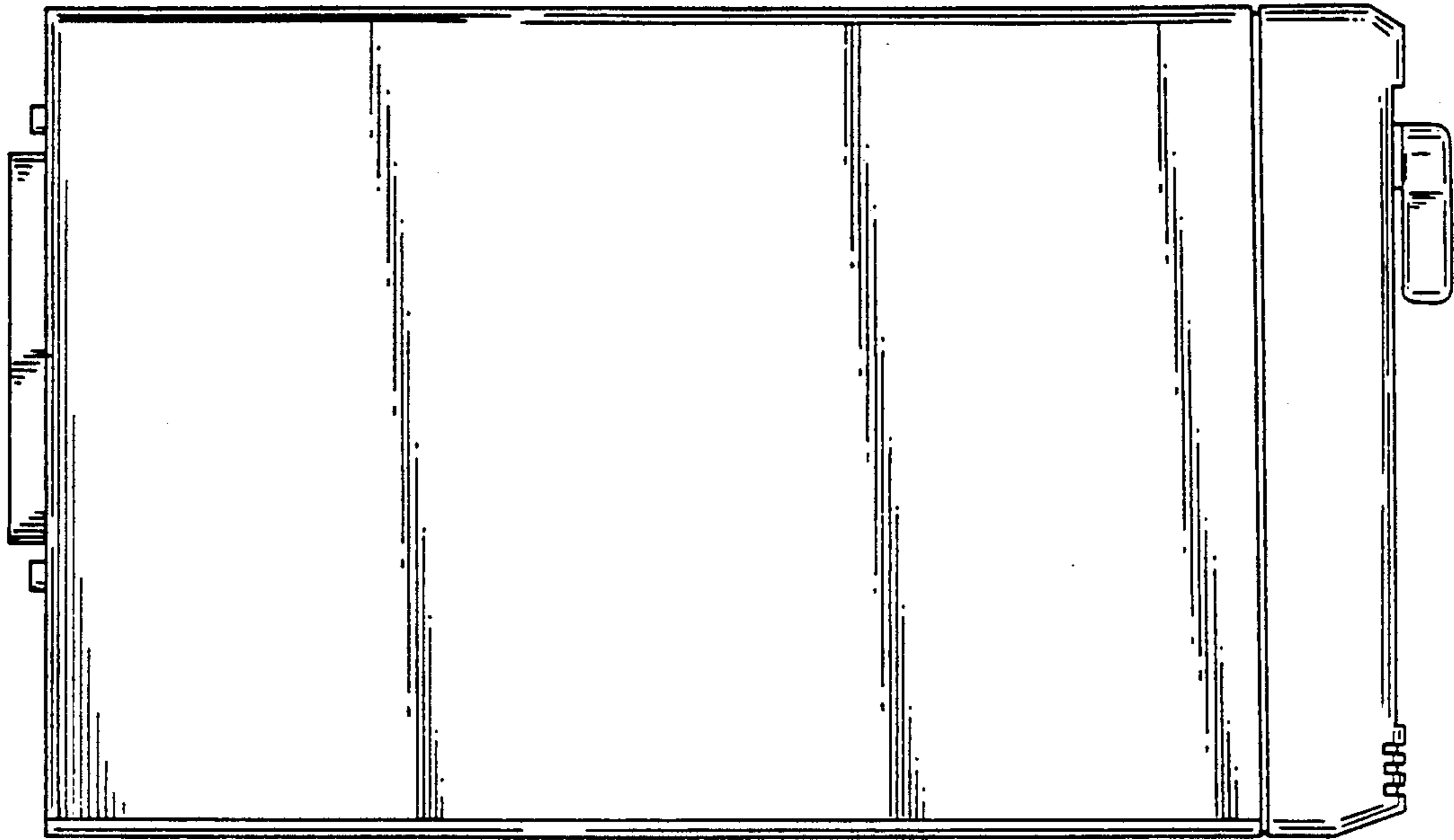

FIG. 4

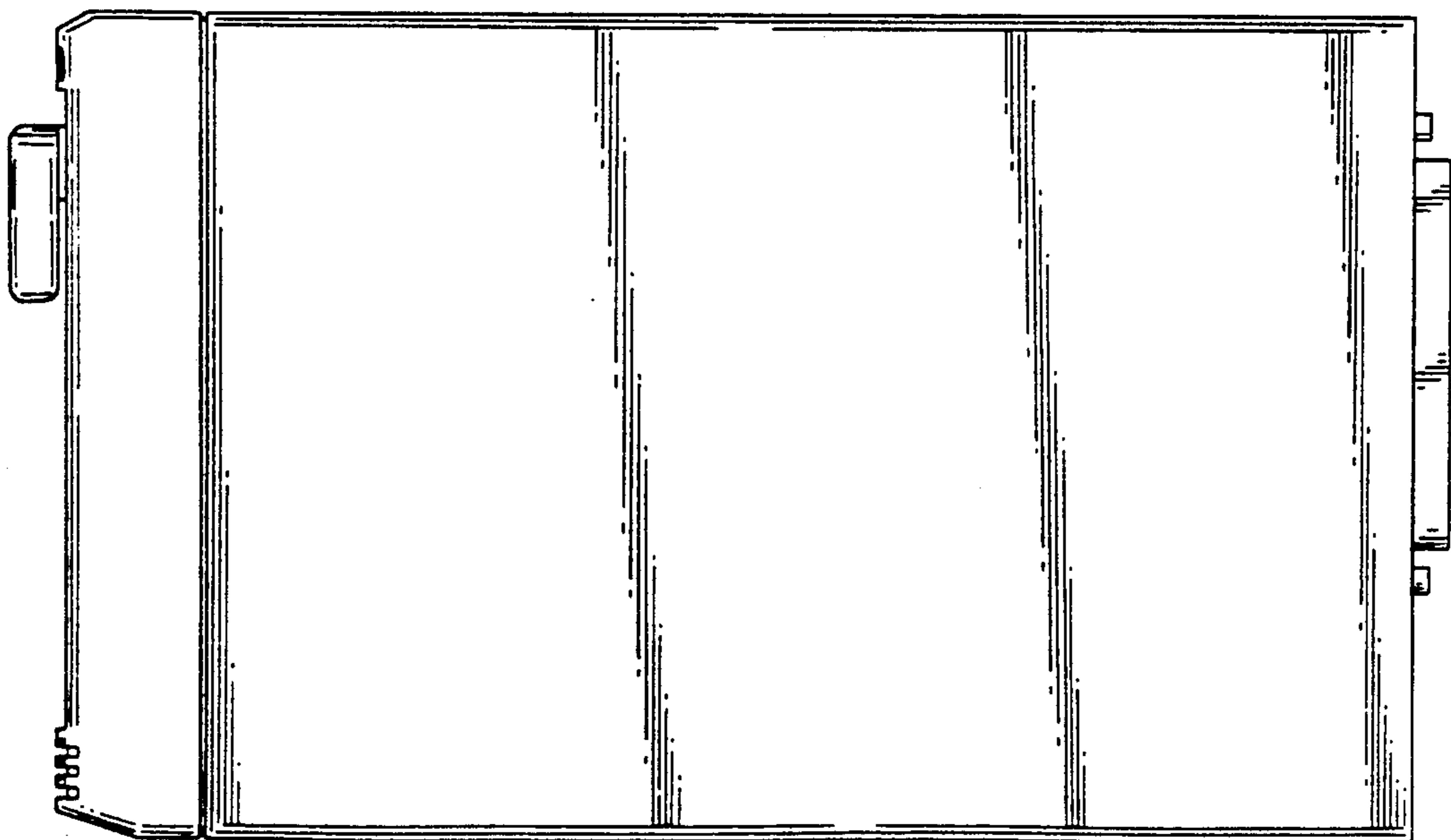

FIG. 6

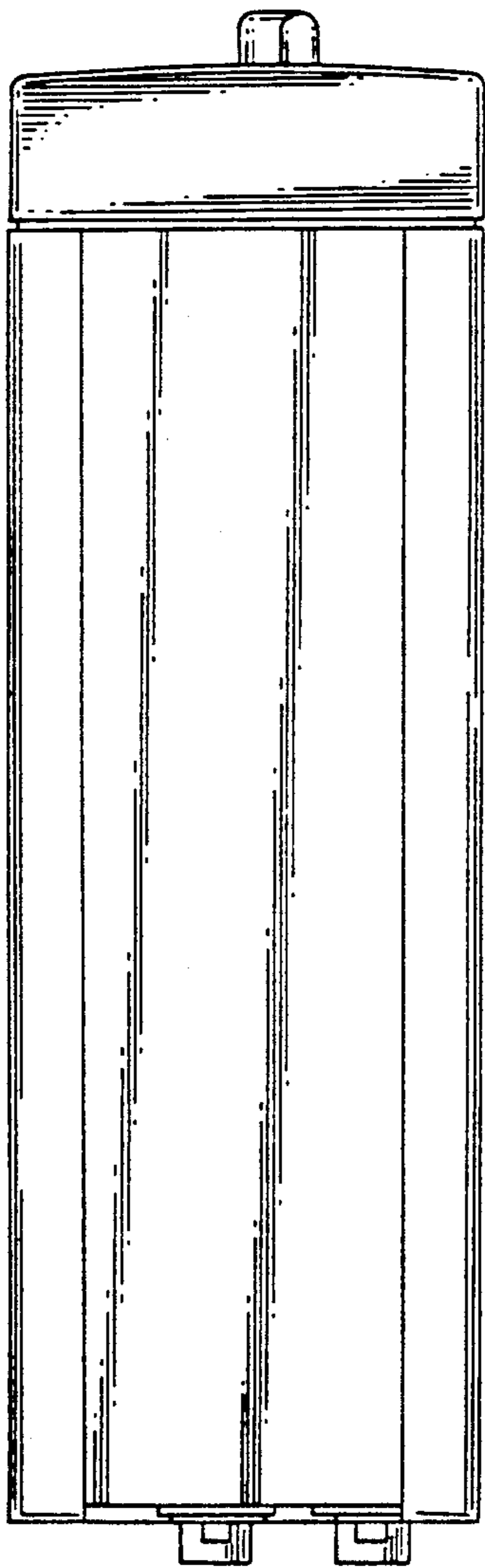

FIG. 5

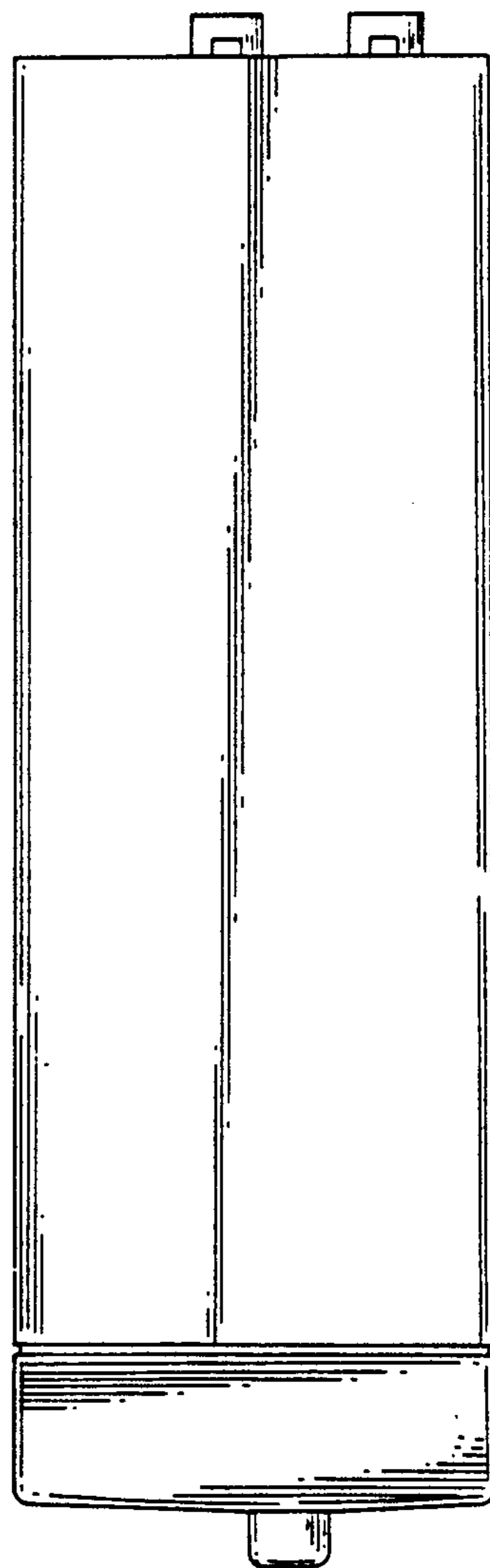

FIG. 7

