

[54] **PLATE OR SIMILAR ARTICLE**

[75] **Inventor:** Steve A. Unger, Manilus, N.Y.
 [73] **Assignee:** Syracuse China Corporation, Syracuse, N.Y.
 [**] **Term:** 14 Years
 [21] **Appl. No.:** 321,347
 [22] **Filed:** Mar. 10, 1989
 [52] **U.S. Cl.** D7/585
 [58] **Field of Search** D7/500, 505, 565-568, D7/570, 550, 552, 584-588

[56] **References Cited**

U.S. PATENT DOCUMENTS

D. 77,080	12/1928	Dolan	D7/570
D. 83,961	4/1931	Fisher	D7/565
D. 100,851	8/1936	Cowan	D7/585
D. 102,742	1/1937	Bottomo	D7/568
D. 228,438	9/1973	Mercadante	D7/585

OTHER PUBLICATIONS

Handbook of Ornament, ©1957 Dover Publ. Franz Salesmeyer, p. 164, top right panel #2.

Primary Examiner—Winifred E. Herrmann
Attorney, Agent, or Firm—Cushman, Darby & Cushman

[57] **CLAIM**

The ornamental design for a plate or similar article, as shown and described.

DESCRIPTION

FIG. 1 is a top plan view of a plate or similar article showing my new design as embodied in a saucer;
 FIG. 2 is a cross-sectional view taken along lines 2—2 of FIG. 1;
 FIG. 3 is a bottom plan view thereof;

FIG. 4 is a side elevational view thereof;
 FIG. 5 is a top plan view of a plate or similar article showing my new design as embodied in a bread, small salad or dessert plate;
 FIG. 6 is a cross-sectional view thereof taken along lines 6—6 of FIG. 5;
 FIG. 7 is a bottom plan view thereof;
 FIG. 8 is a side elevational view thereof;
 FIG. 9 is a top plan view of a plate or similar article showing my new design as embodied in a larger salad and dessert plate;
 FIG. 10 is a cross-sectional view thereof taken along line 10—10 of FIG. 9;
 FIG. 11 is a bottom plan view thereof;
 FIG. 12 is a side elevational view thereof;
 FIG. 13 is a top plan view of a plate or similar showing my new design as embodied in a sandwich plate;
 FIG. 14 is a cross-sectional view taken along line 14—14 of FIG. 13;
 FIG. 15 is a bottom plan view thereof;
 FIG. 16 is a cross-sectional view thereof;
 FIG. 17 is a top plan view of a plate or similar article showing my new design as embodied in a dinner plate;
 FIG. 18 is a cross-sectional view taken along line 18—18 of FIG. 17;
 FIG. 19 is a bottom plan view thereof;
 FIG. 20 is a side elevational view thereof;
 FIG. 21 is a top plan view of a plate or similar article showing my new design as embodied in a serving plate;
 FIG. 22 is a cross-sectional view thereof taken along line 22—22 of FIG. 21;
 FIG. 23 is a bottom plan view thereof; and
 FIG. 24 is a side elevational view thereof.
 The characteristic feature of my design resides in the palmette-like decoration incised into the upper surface of the rim in combination with the configuration of the plate or similar article as best shown in FIGS. 1, 5, 9, 13, 17, and 21 on the drawing.

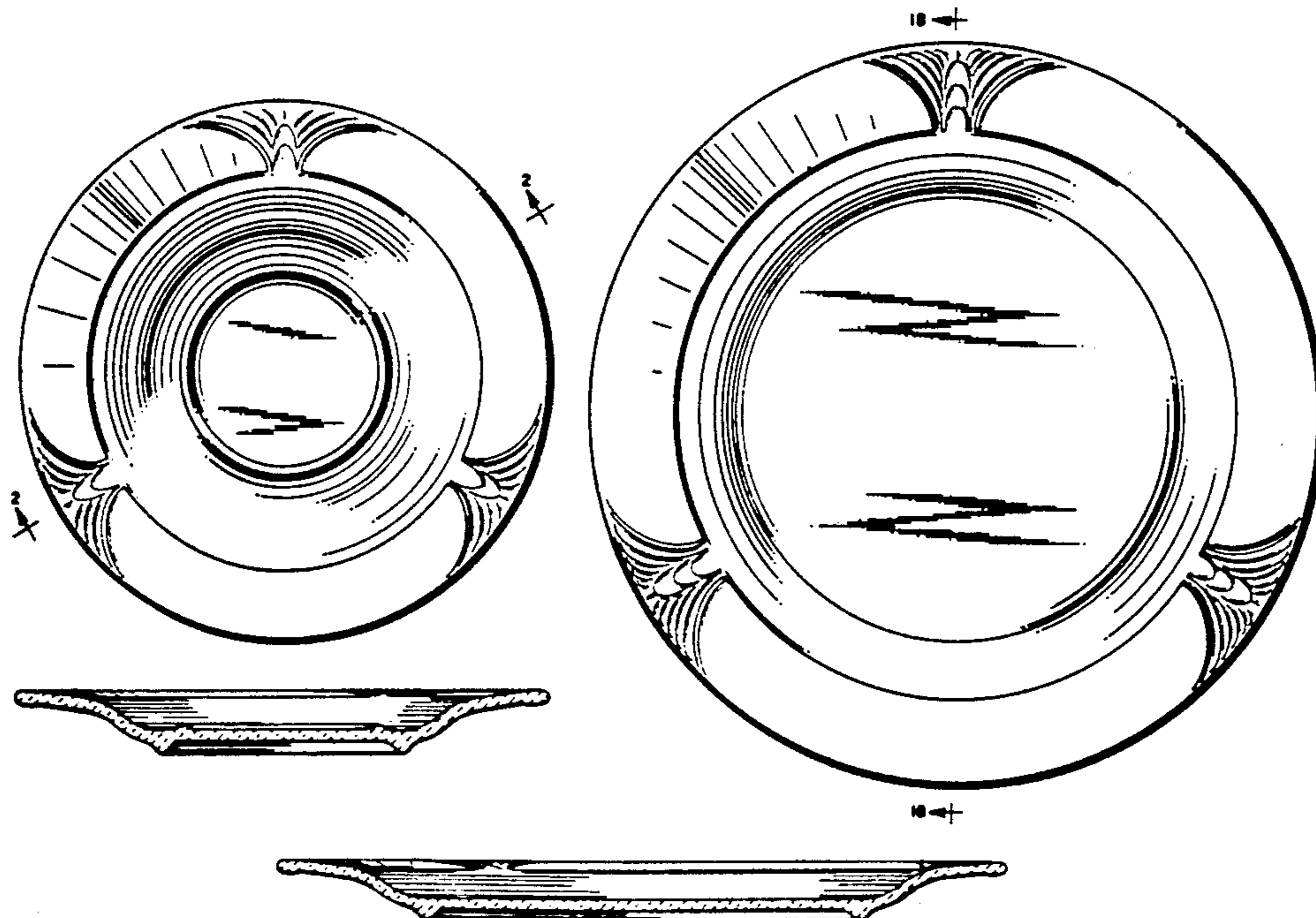

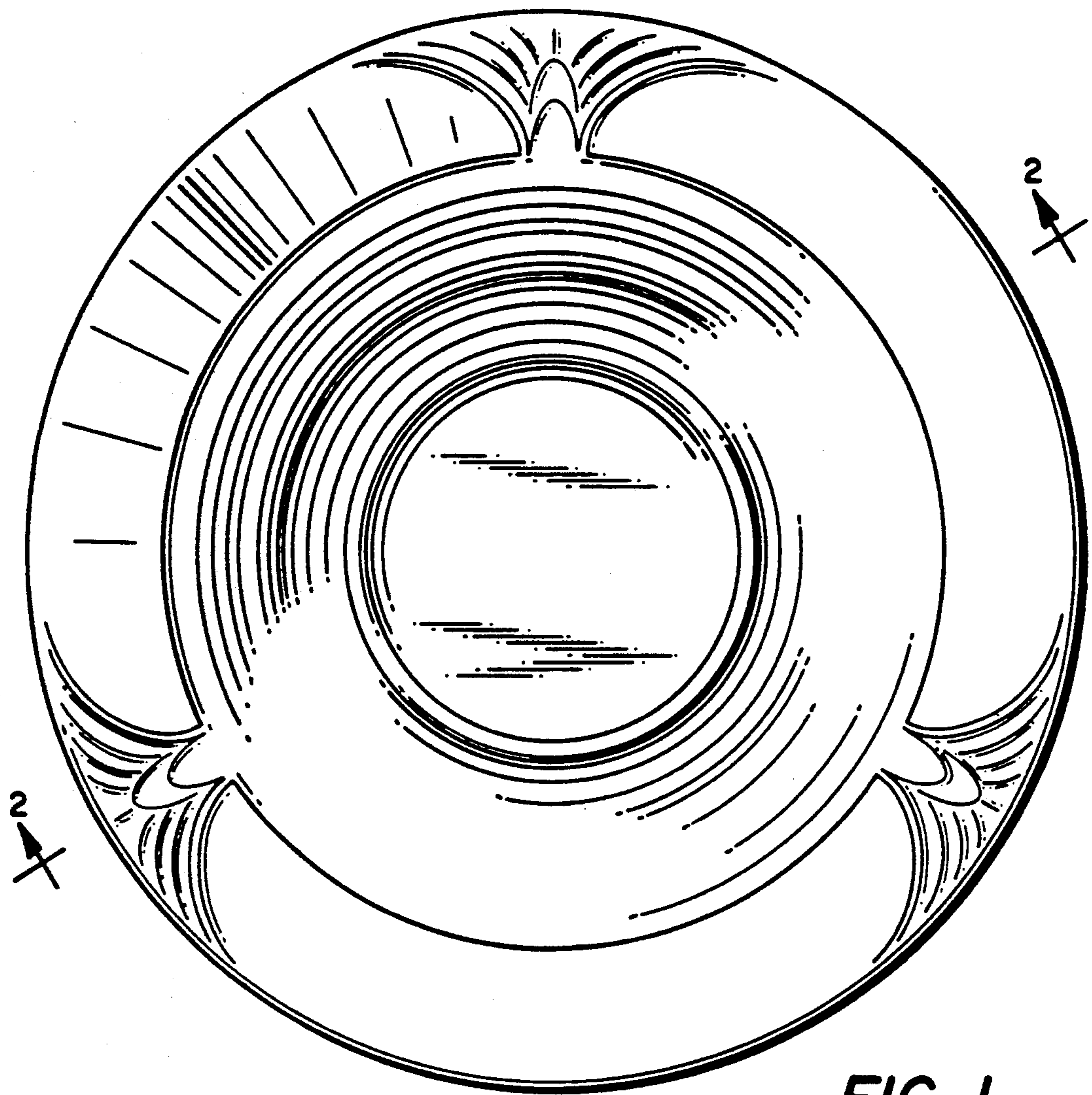

FIG. 1

FIG. 2



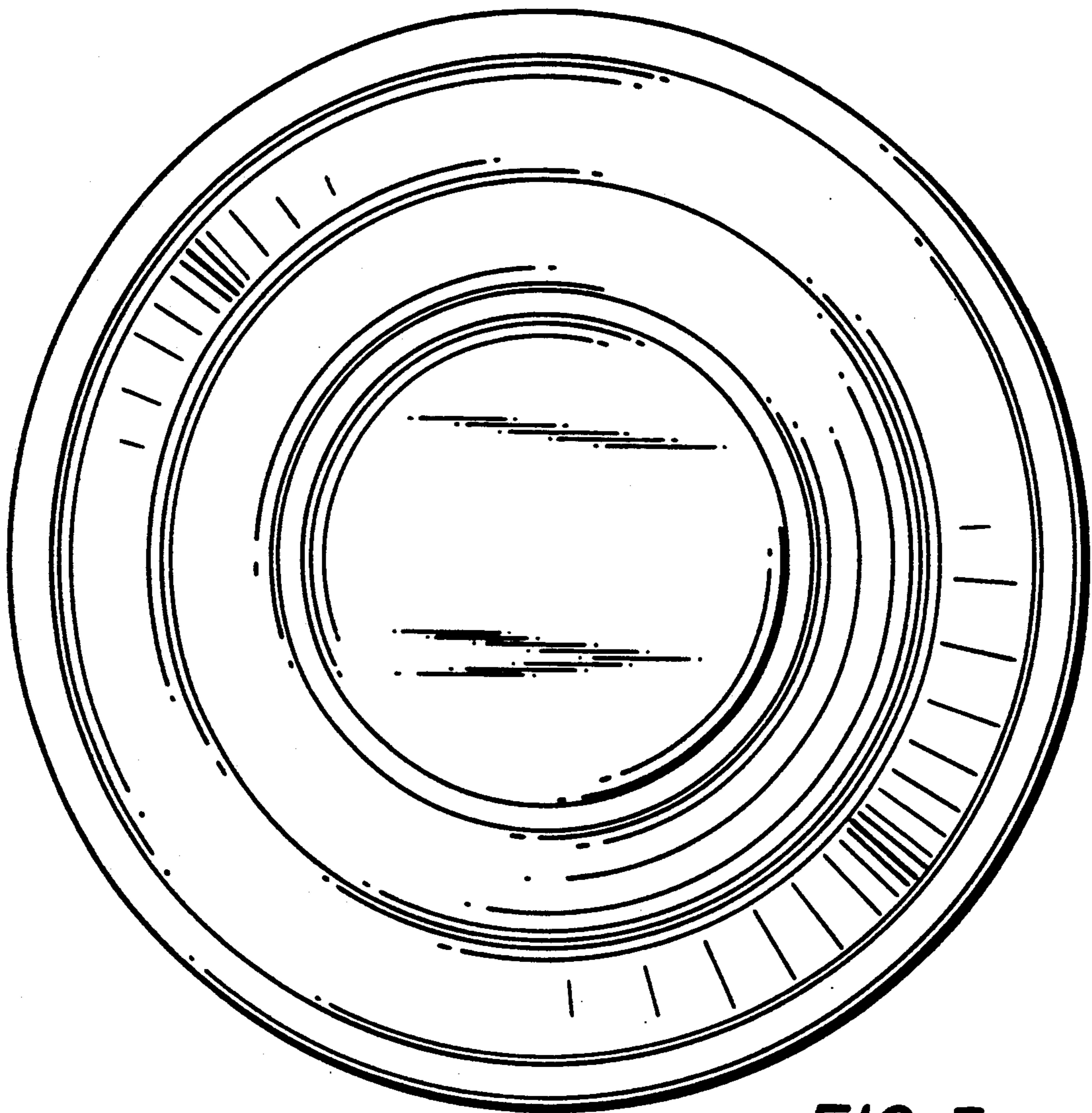
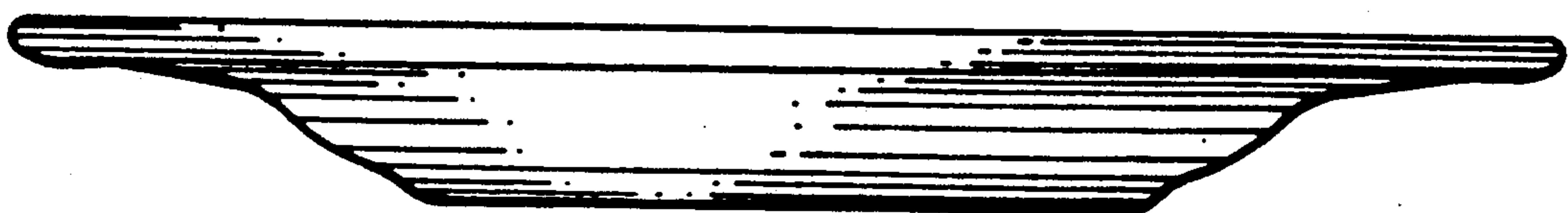

FIG. 3

FIG. 4



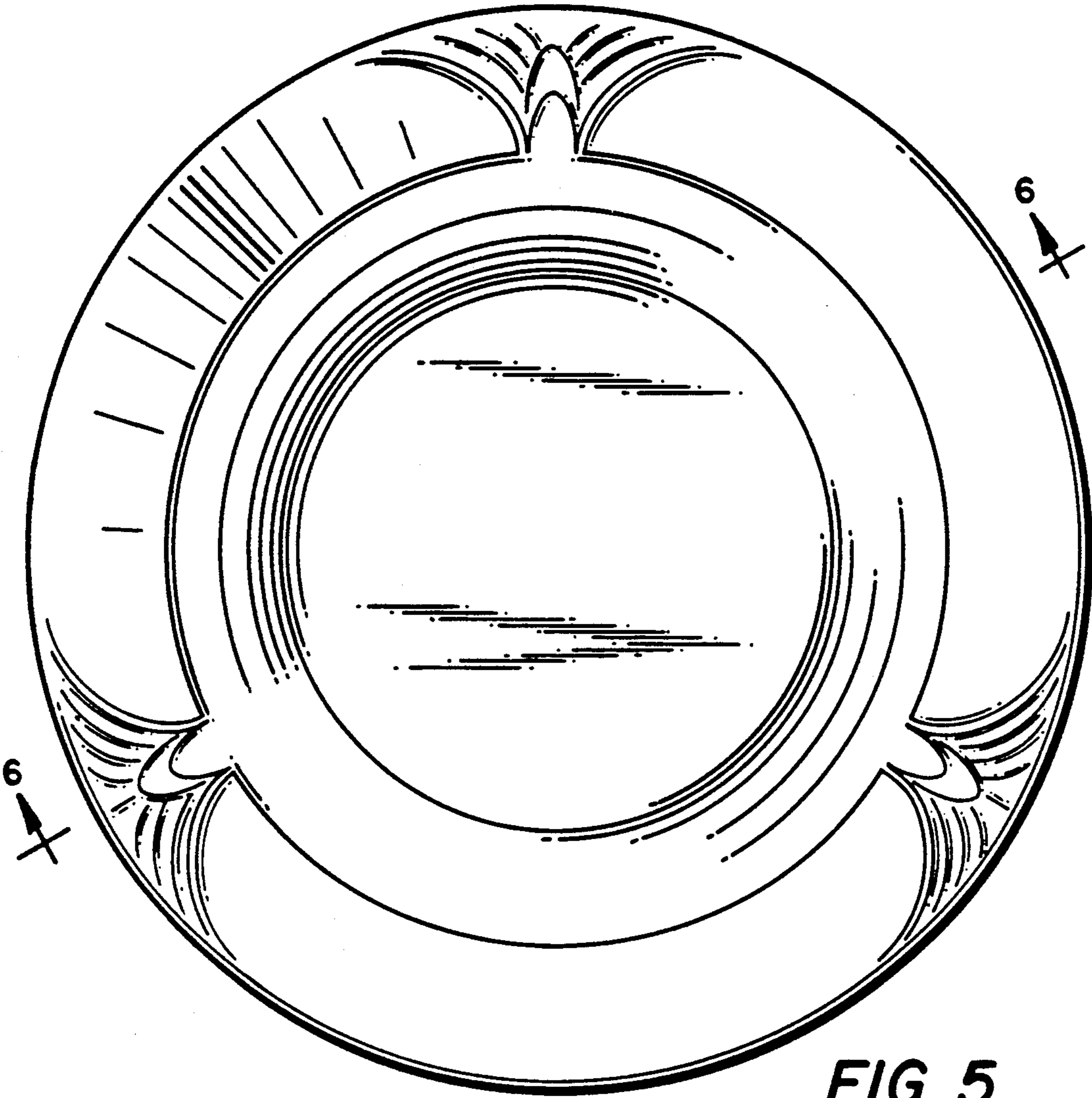
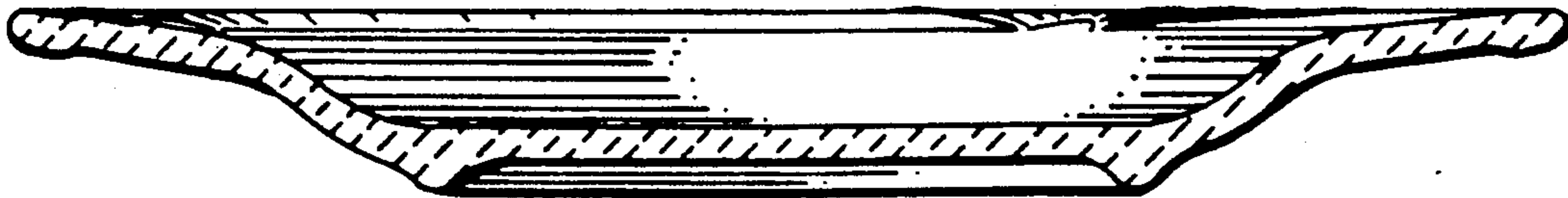

FIG. 5

FIG. 6



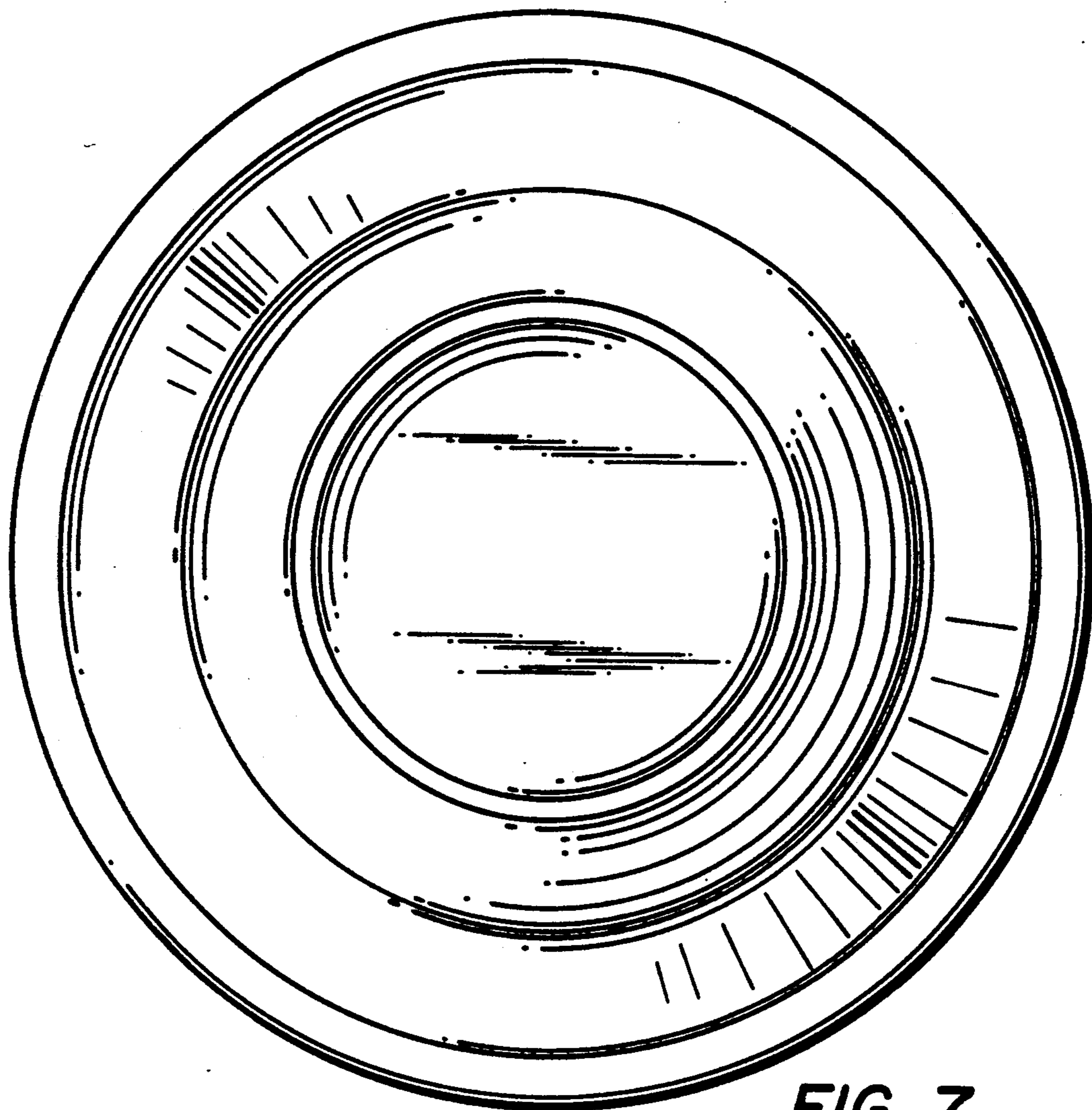
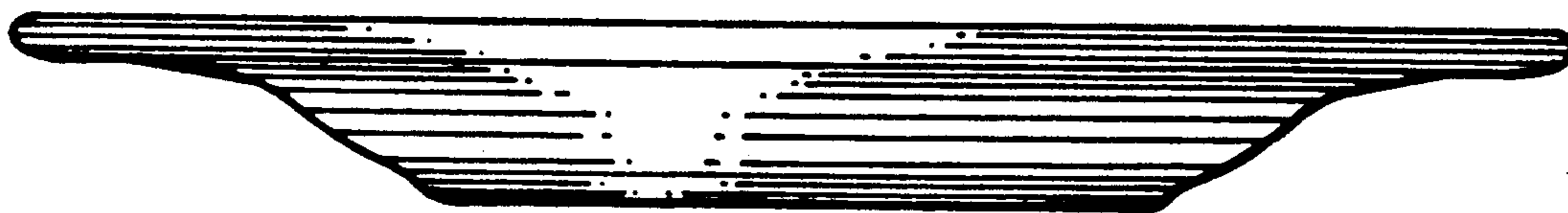

FIG. 7

FIG. 8



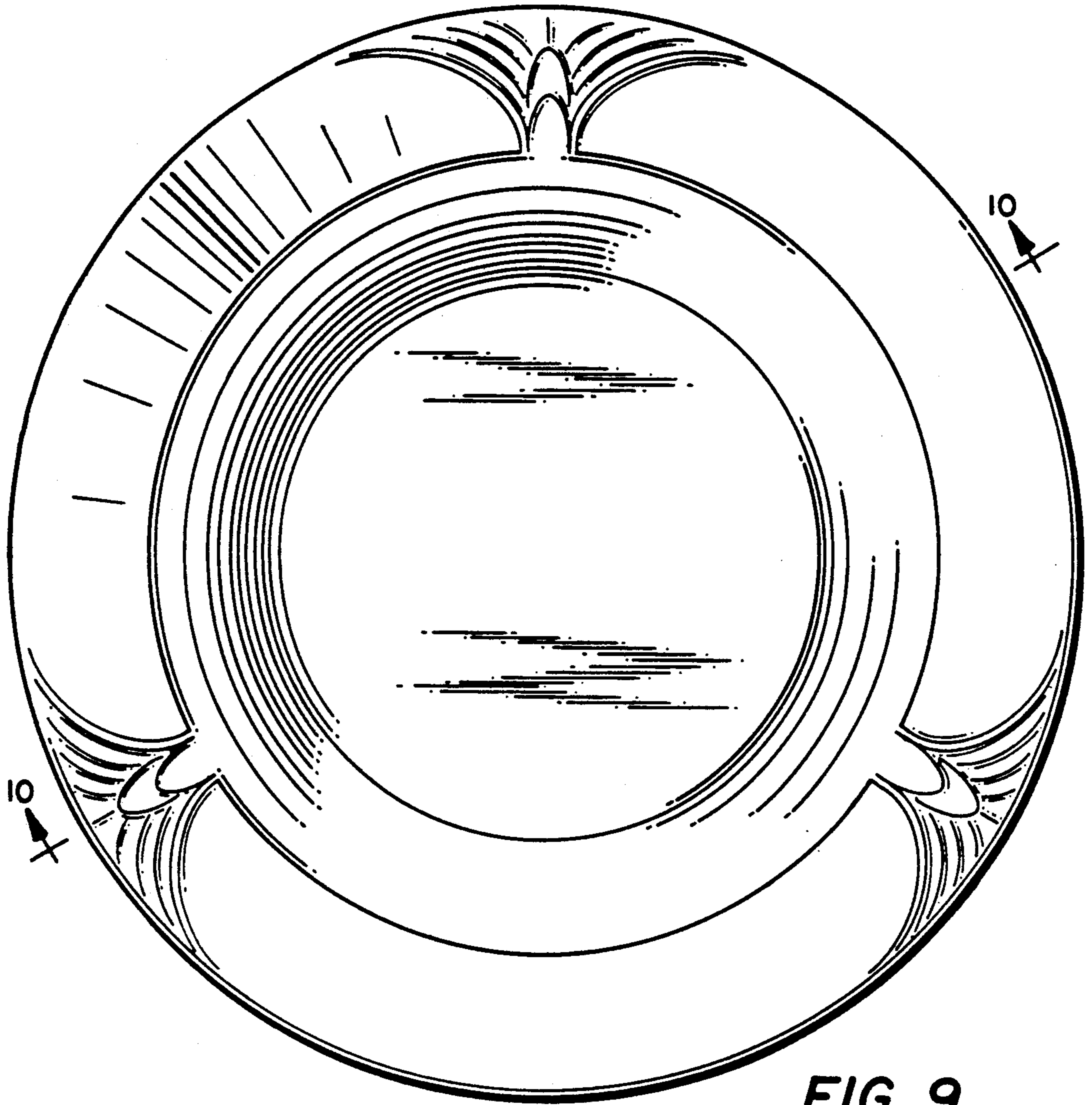
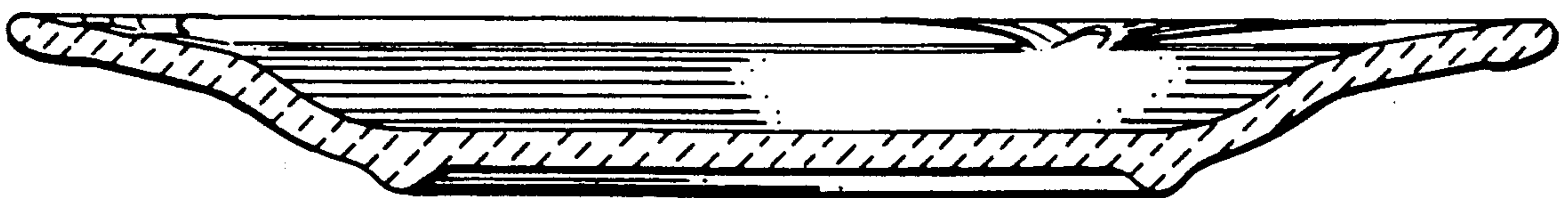

FIG. 9

FIG. 10



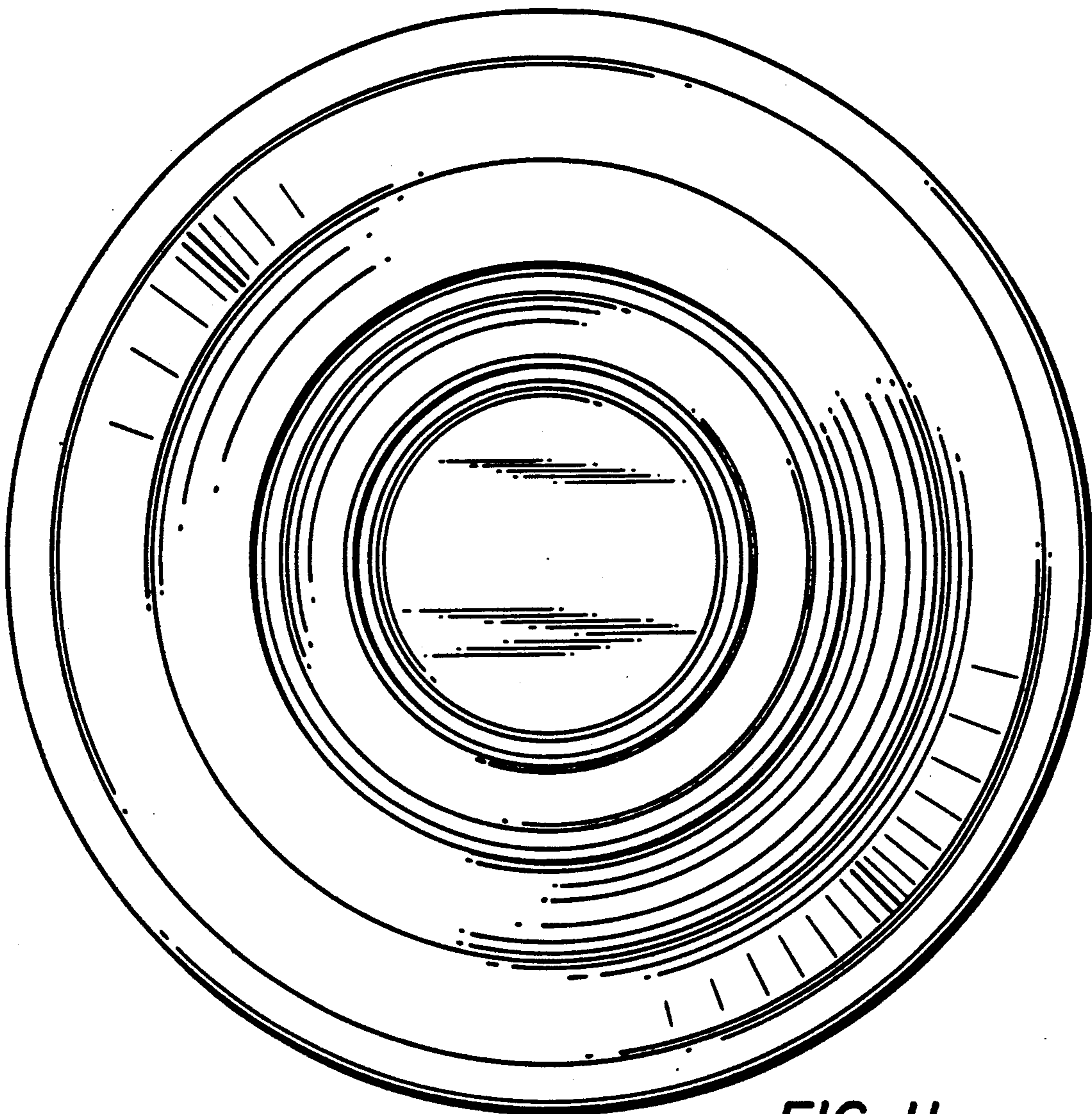
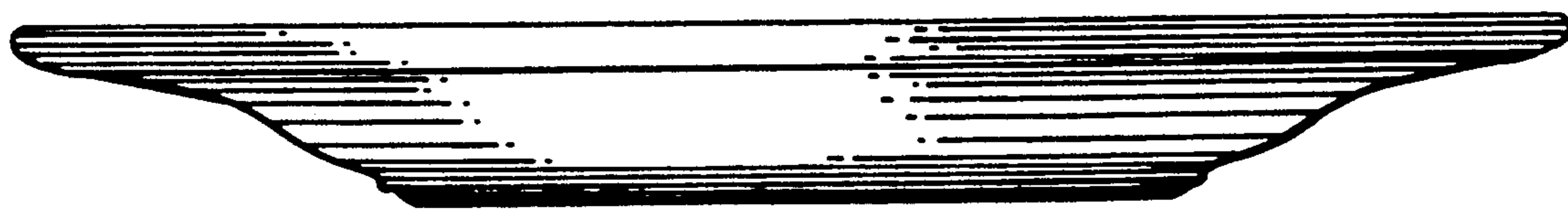

FIG. 11

FIG. 12



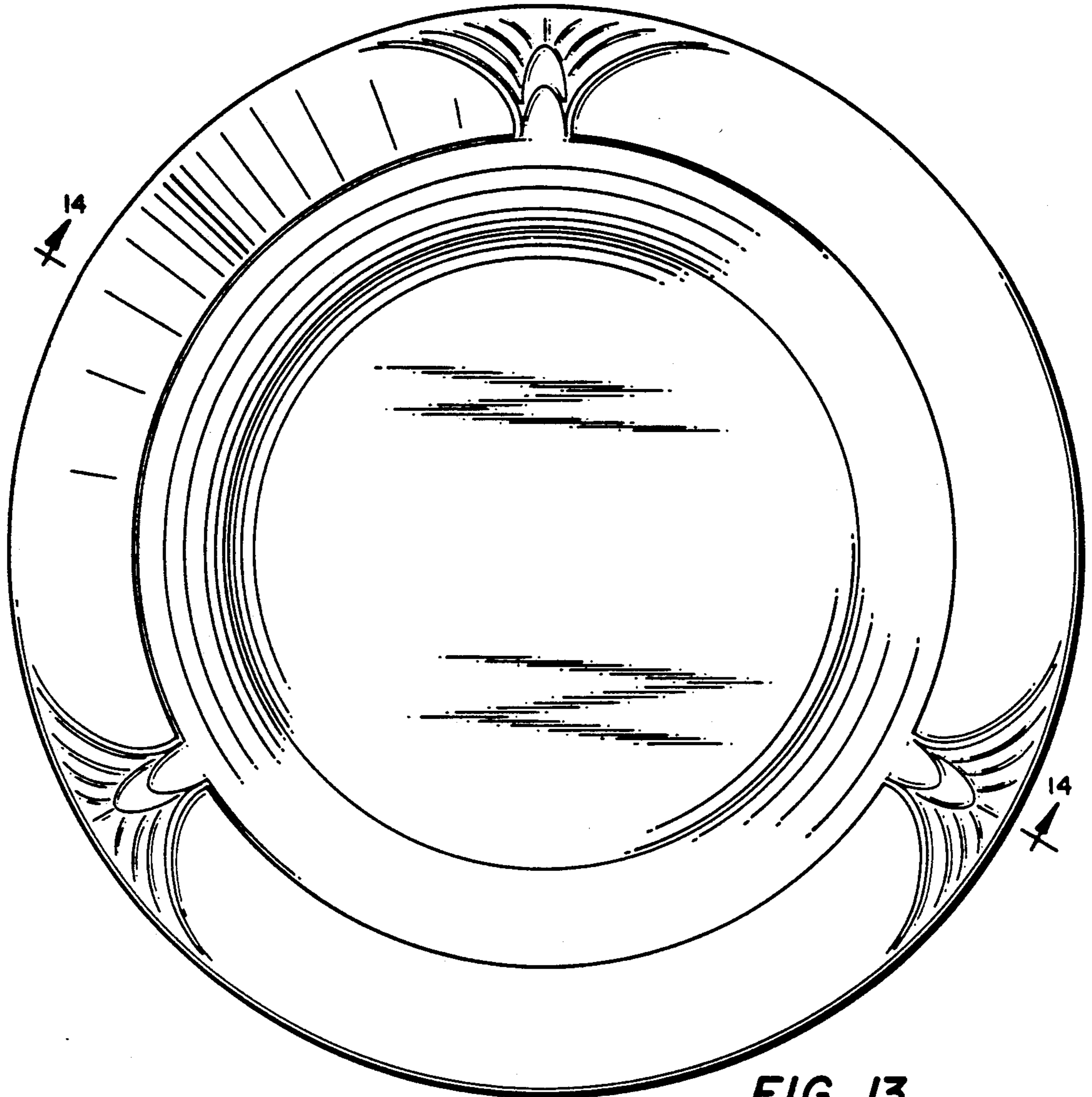
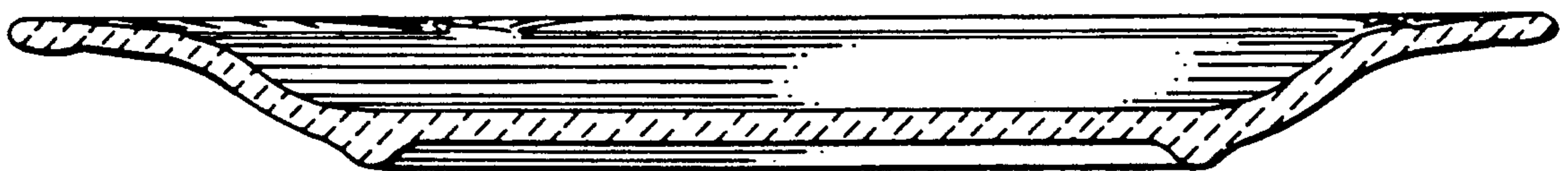

FIG. 13

FIG. 14



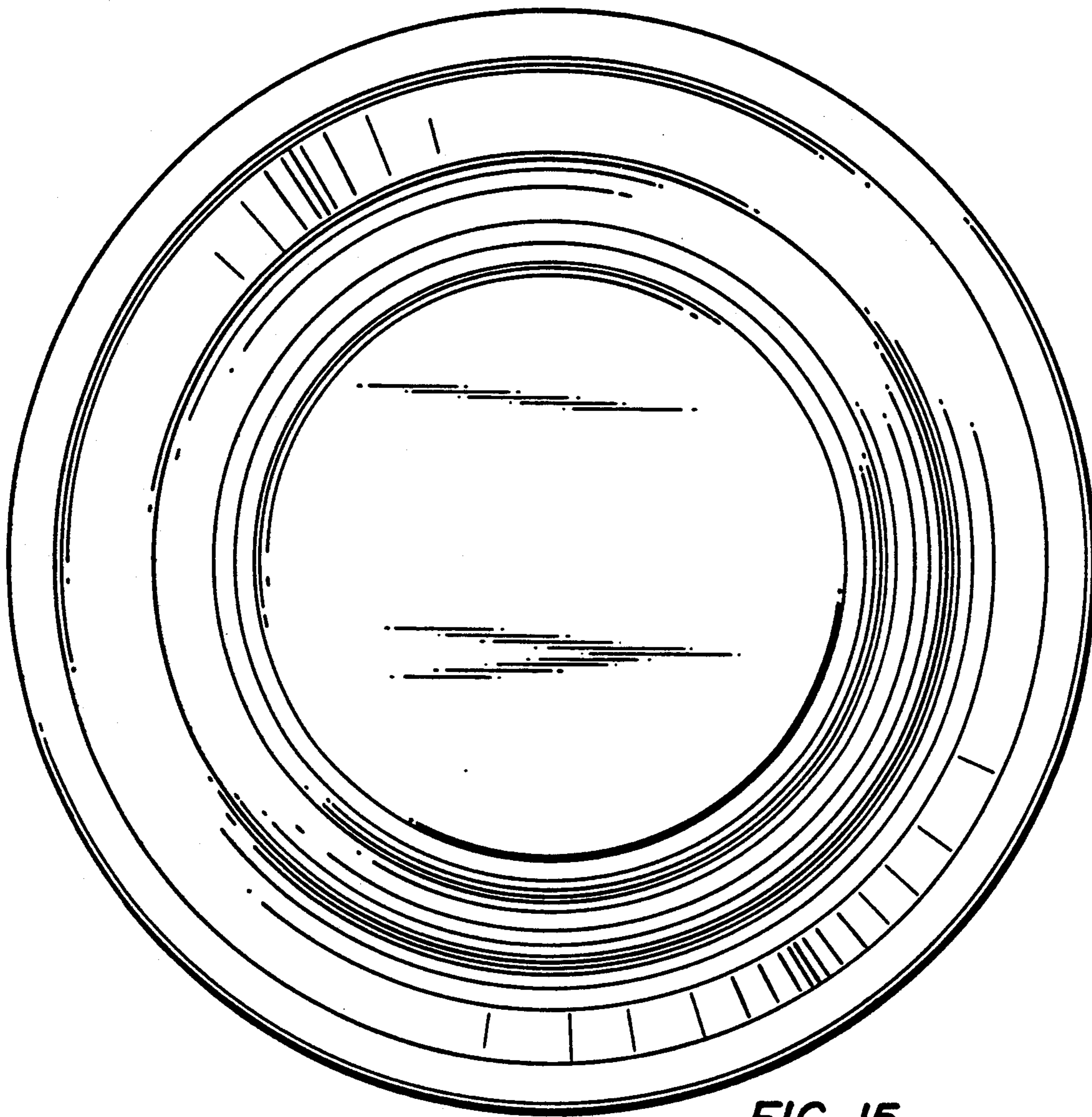
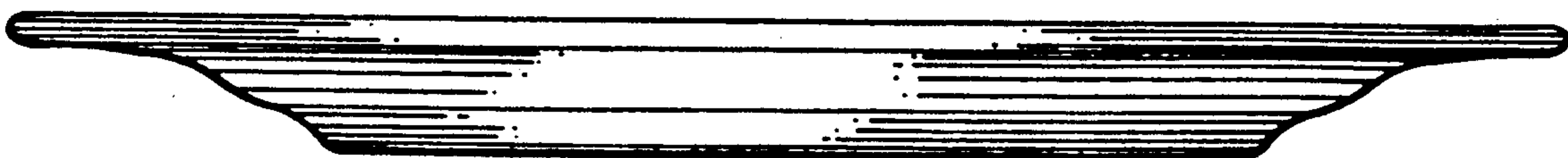
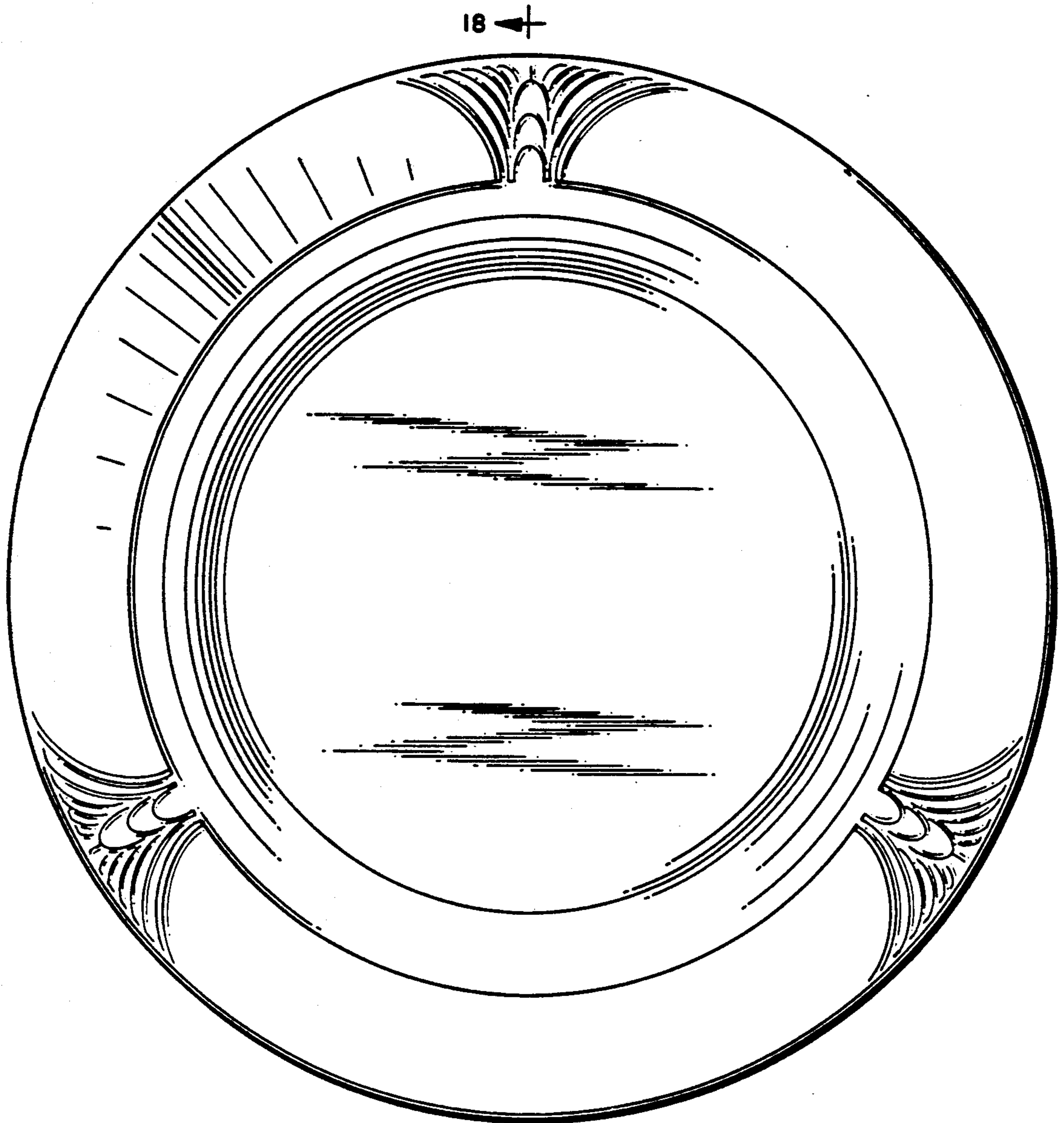

FIG. 15

FIG. 16





18 ←

FIG. 17

FIG. 18

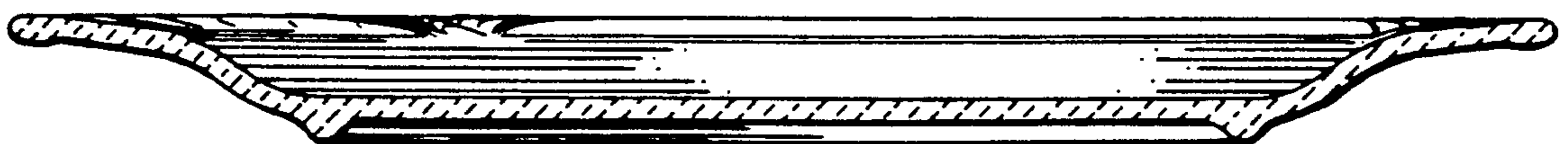

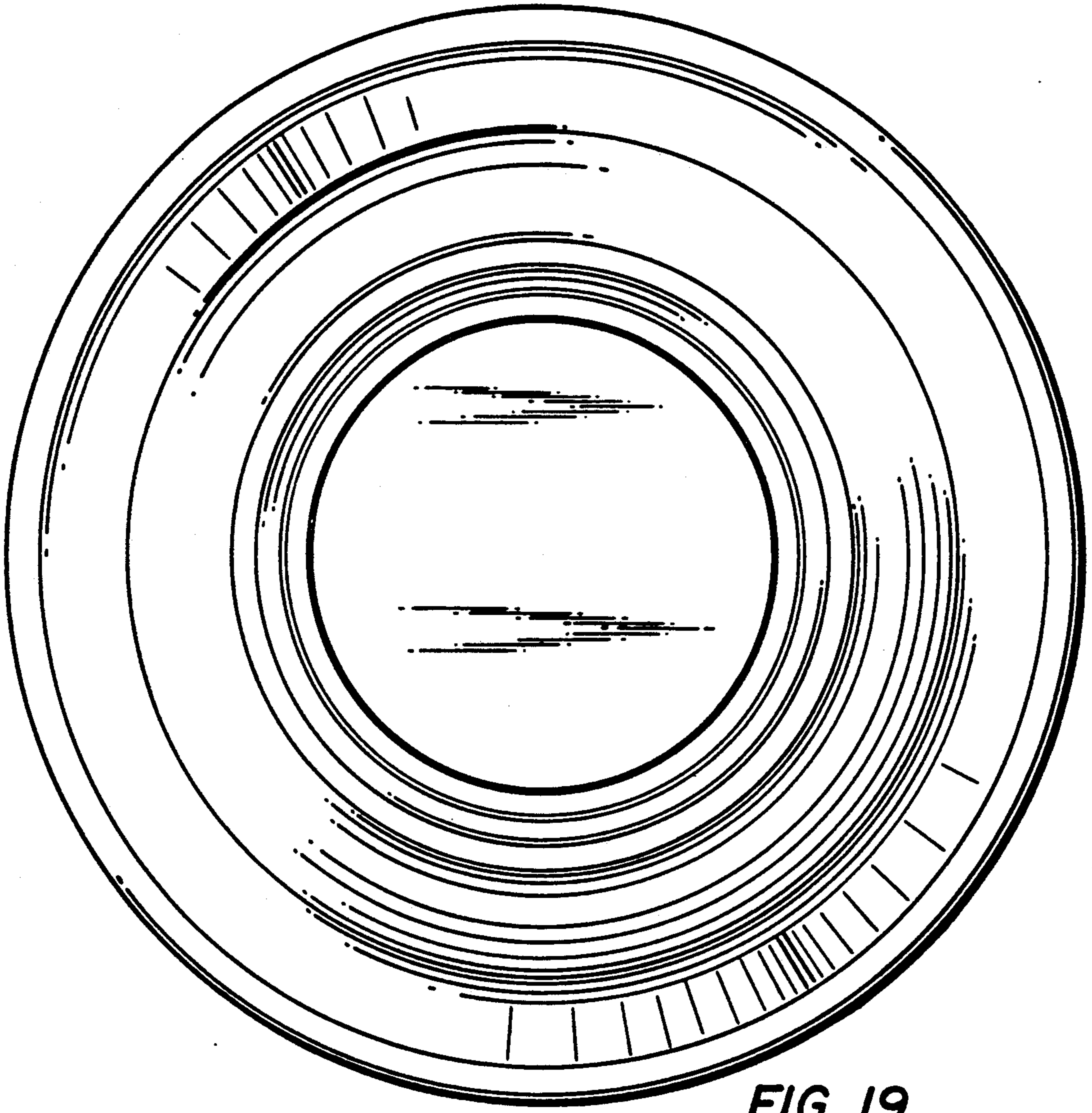
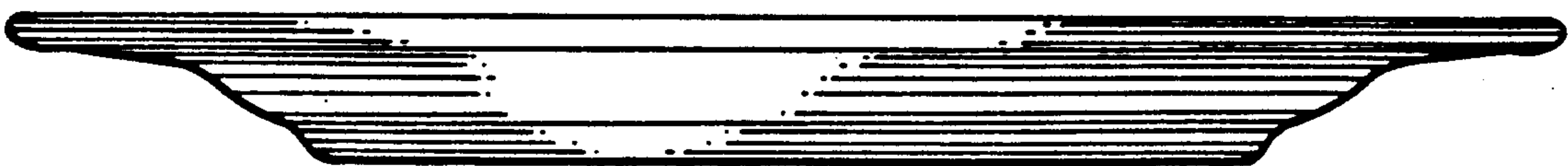
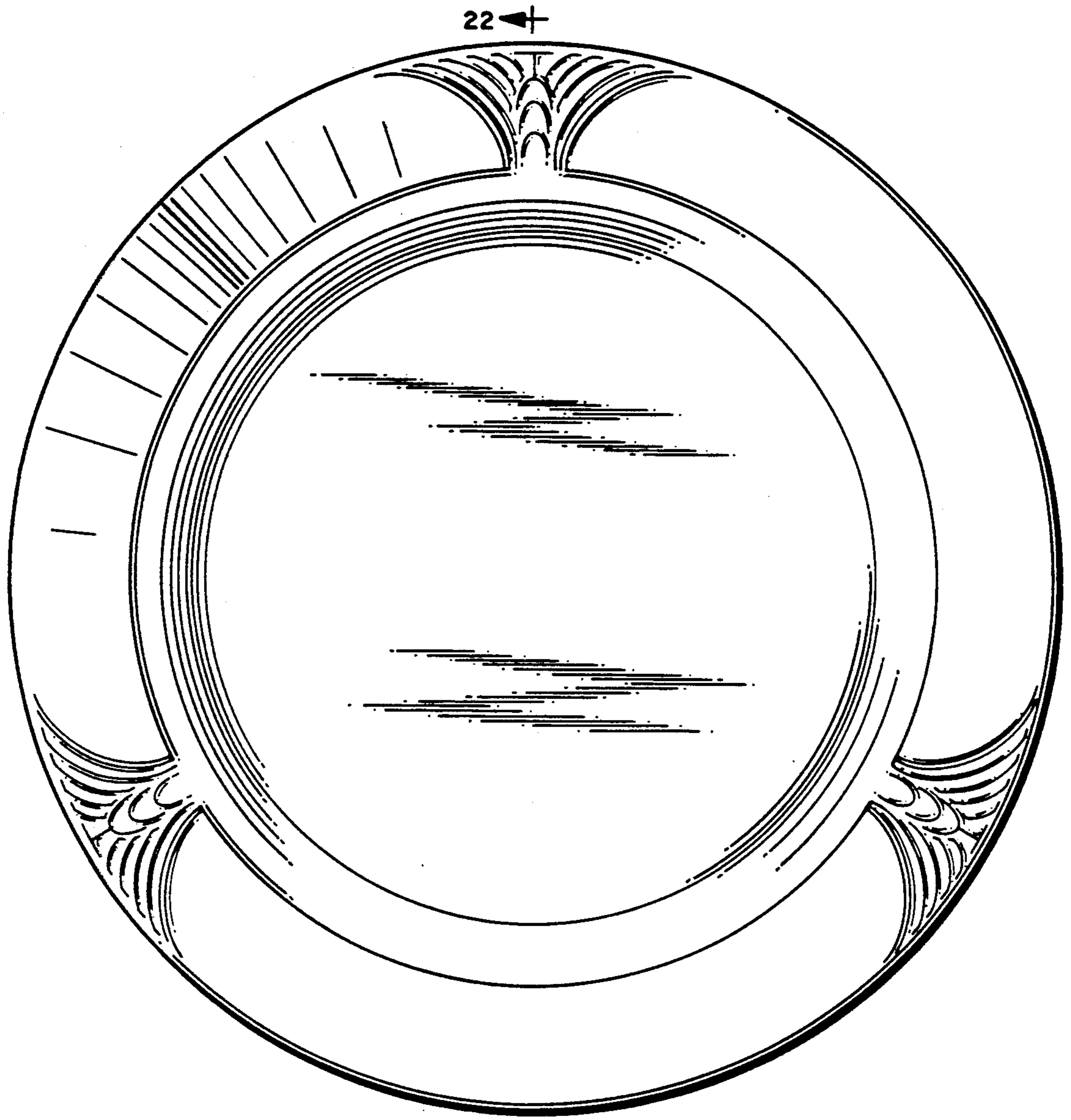

FIG. 19

FIG. 20





22 ← +

22 ← +

FIG. 21

FIG. 22

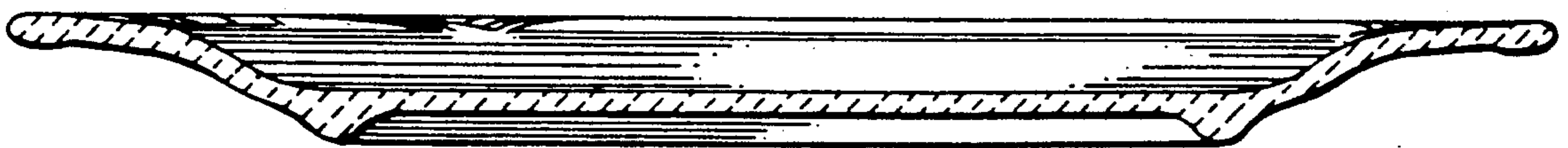

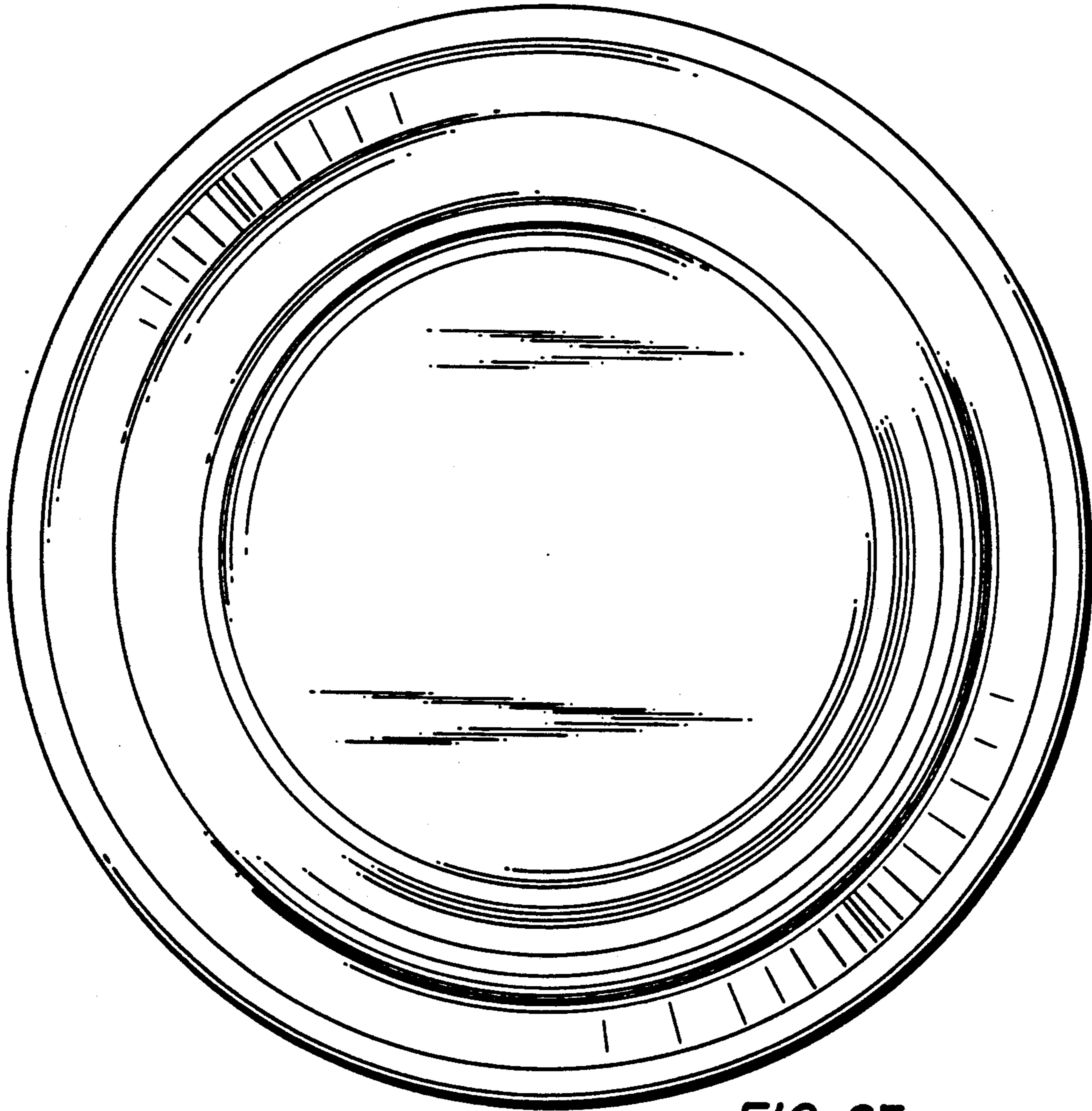

FIG. 23

FIG. 24

