

[54] **HANDSET FOR A TELEPHONE BASE**

[75] **Inventor: Maki Myoga, Portland, Oreg.**

[73] **Assignee: Code-A-Phone Corporation, Clackamas, Oreg.**

[\*\*] **Term: 14 Years**

[21] **Appl. No.: 638,650**

[22] **Filed: Jan. 8, 1991**

[52] **U.S. Cl. .... D14/138; D14/147; D14/248; D14/148; D14/151**

[58] **Field of Search ..... D14/138, 147, 148, 248, D14/151, 1; 379/440, 433, 434, 436; D4/111**

[56] **References Cited**

**U.S. PATENT DOCUMENTS**

D. 269,873	7/1983	Nagele et al. ....	D14/147
D. 274,243	6/1984	Asaki et al. ....	D14/138
D. 286,778	11/1986	Beaumont ....	D14/138
D. 305,231	12/1989	Sutoh ....	D14/150
D. 306,291	2/1990	Watanabe et al. ....	D14/148
D. 311,397	10/1990	Cheng ....	D14/149
D. 311,916	11/1990	Tomematu et al. ....	D14/148
D. 316,857	5/1991	Park ....	D14/151
D. 317,156	5/1991	Van Engelsen et al. ....	D14/138
4,979,205	12/1990	Haraguchi et al. ....	379/62

**OTHER PUBLICATIONS**

B. A. Pargh Catalog ©1989; State of Art Uniden, GE, Valor, Panasonic & Universal Cordless Phone, pp. 348 & 349.

*Primary Examiner*—Horace B. Fay, Jr.  
*Attorney, Agent, or Firm*—Fitch, Even, Tabin & Flannery

[57] **CLAIM**

The ornamental design for a handset for a telephone base, as shown and described.

**DESCRIPTION**

FIG. 1 is a perspective view of a handset for a telephone base showing my new design and rotated to show the back thereof;

FIG. 2 is a perspective view rotated to show the front thereof;

FIG. 3 is a top plan view thereof;

FIG. 4 is a back elevational view thereof;

FIG. 5 is a left elevational view thereof;

FIG. 6 is a front elevational view thereof;

FIG. 7 is a right elevational view thereof; and

FIG. 8 is a bottom plan view thereof.

The broken line showing in FIG. 1 of a base for a telephone set is for illustrative purposes only and forms no part of the claimed design.

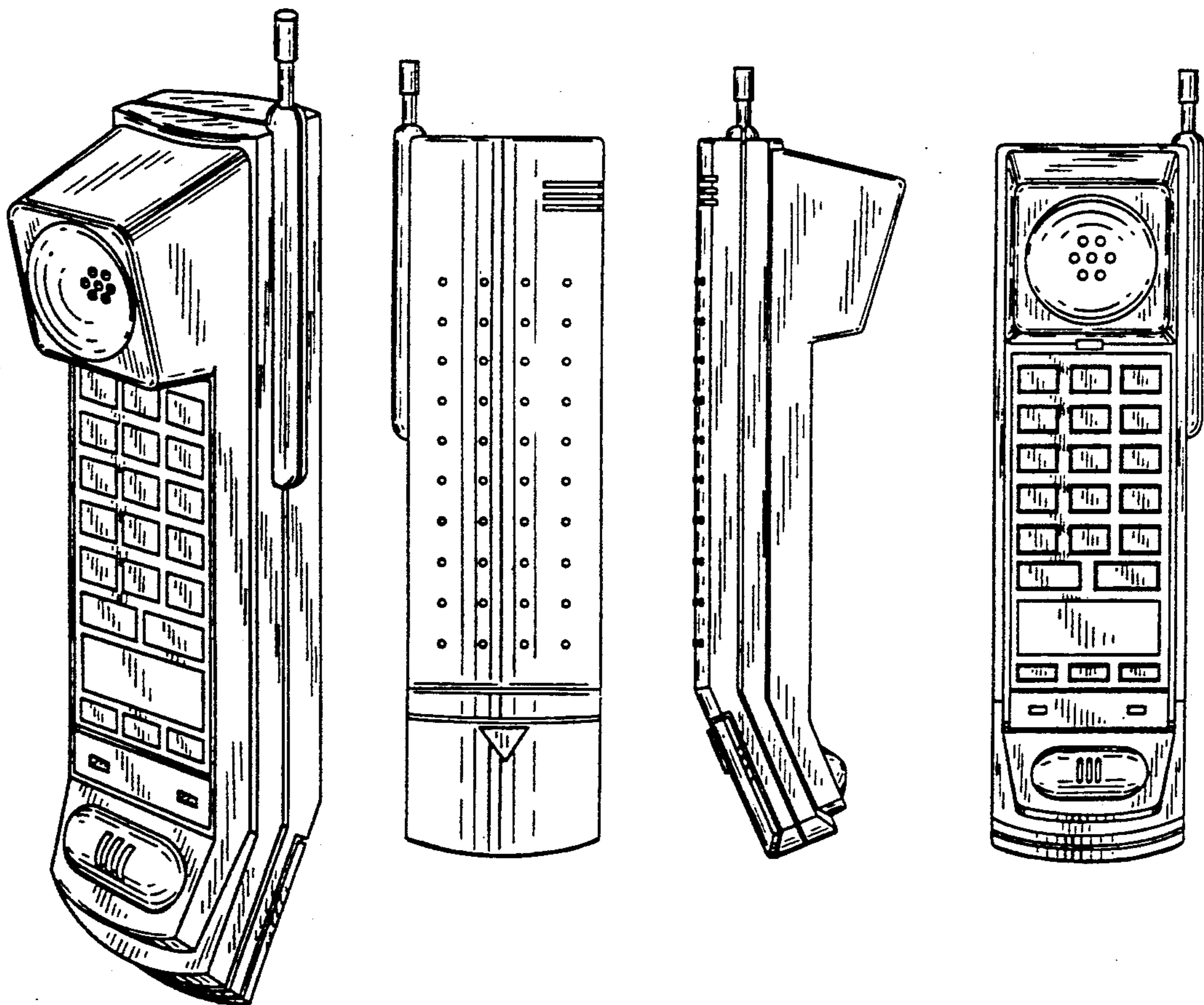

FIG. 1

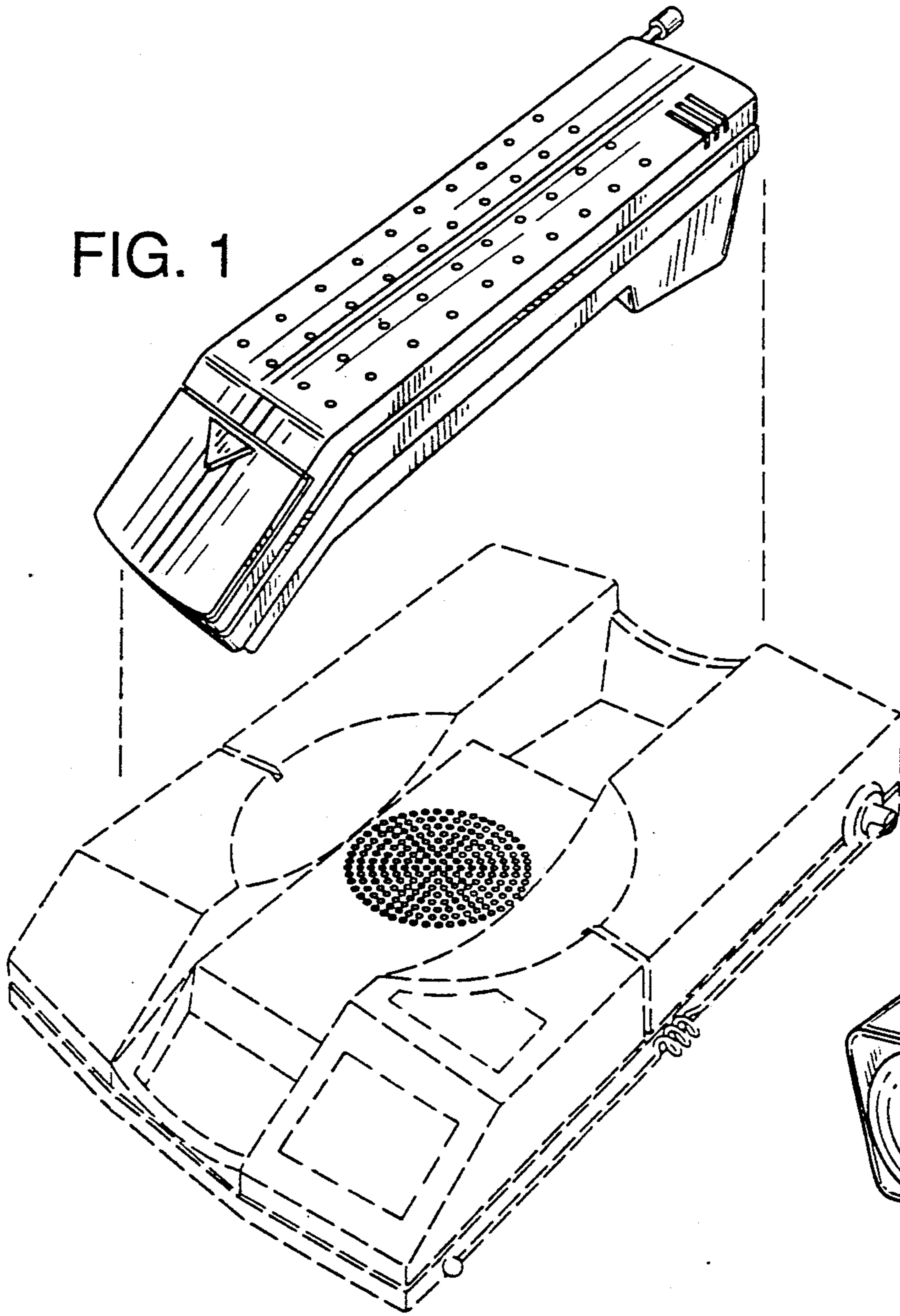

FIG. 2

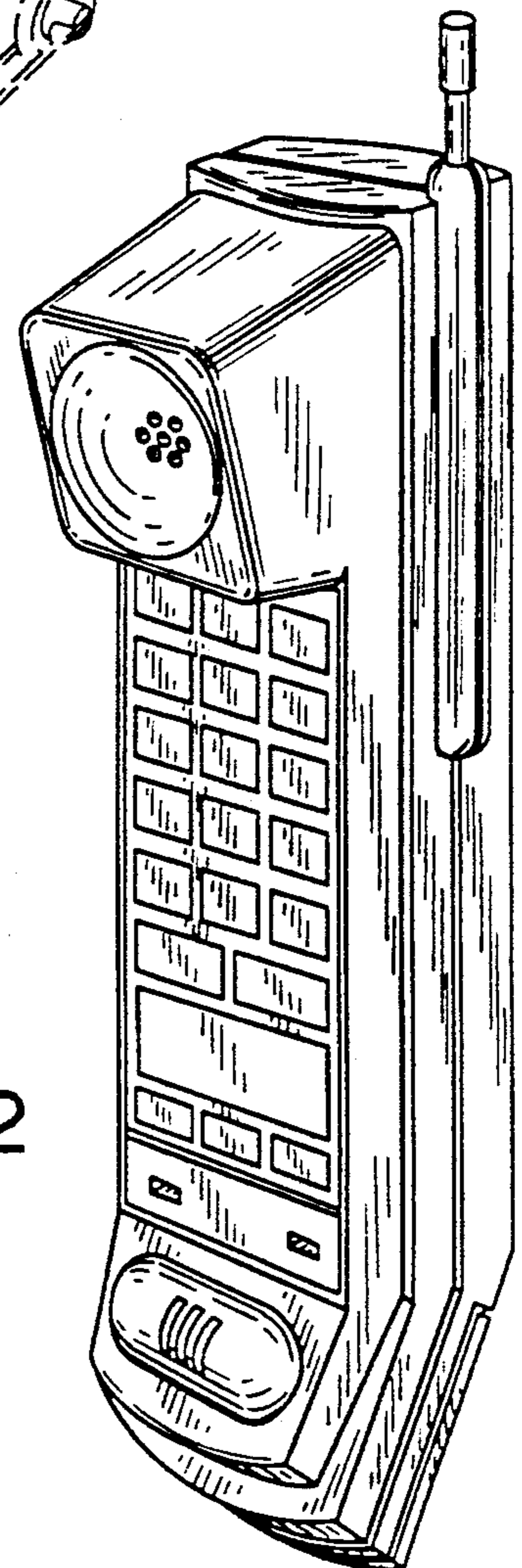

FIG. 3

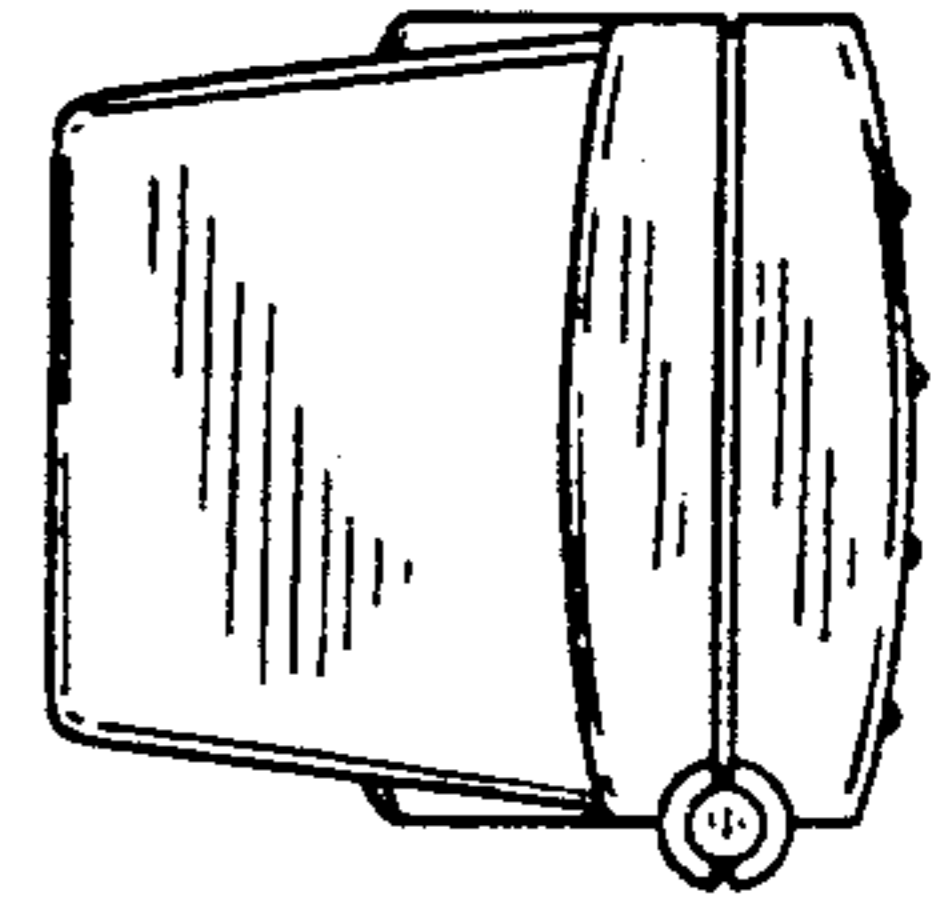

FIG. 4

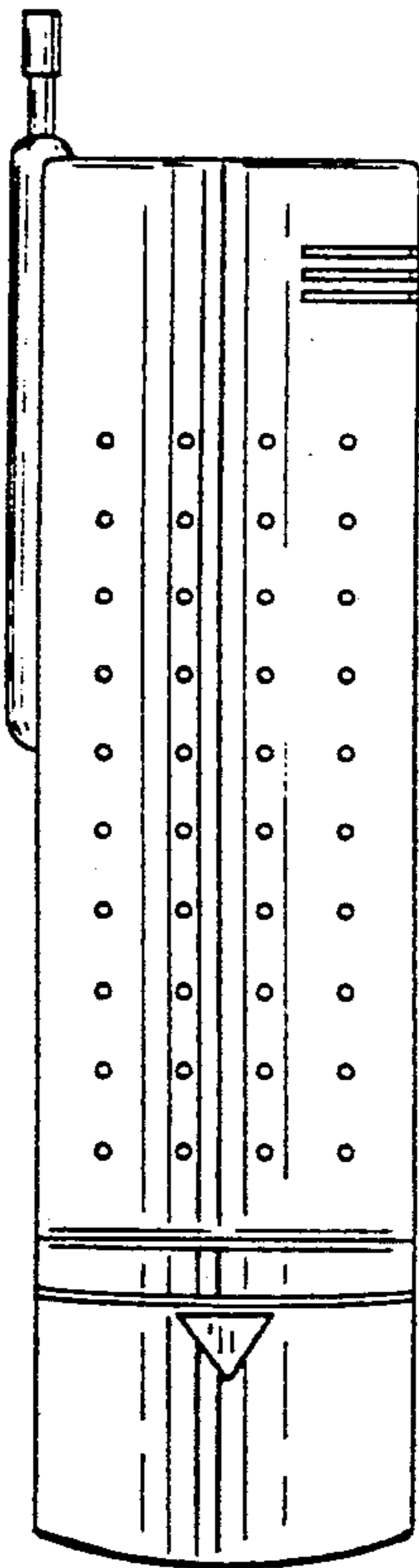

FIG. 5

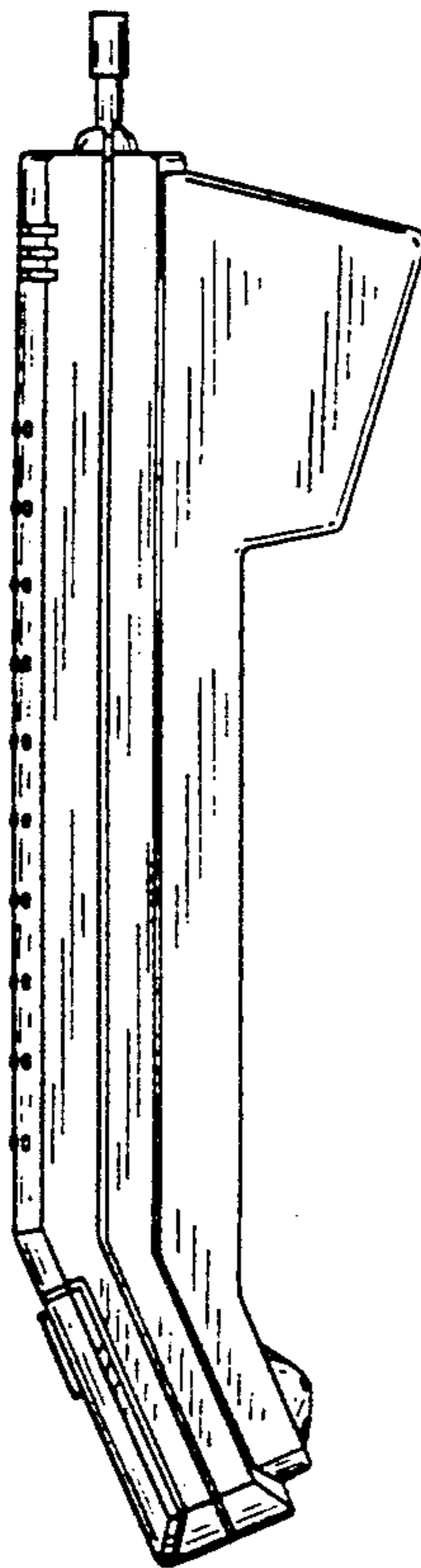

FIG. 6

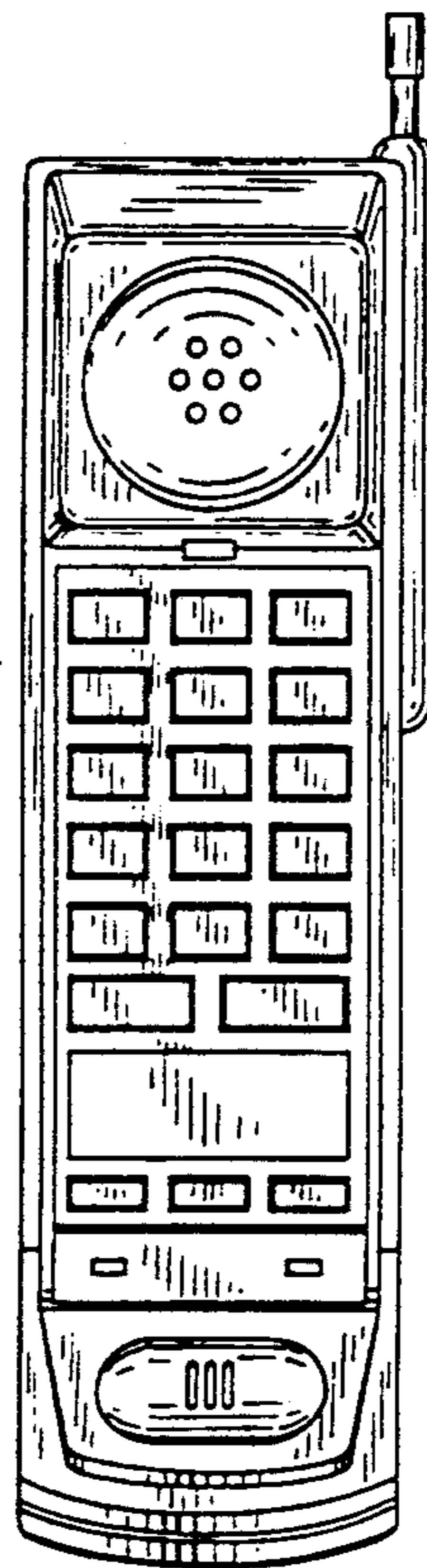

FIG. 7

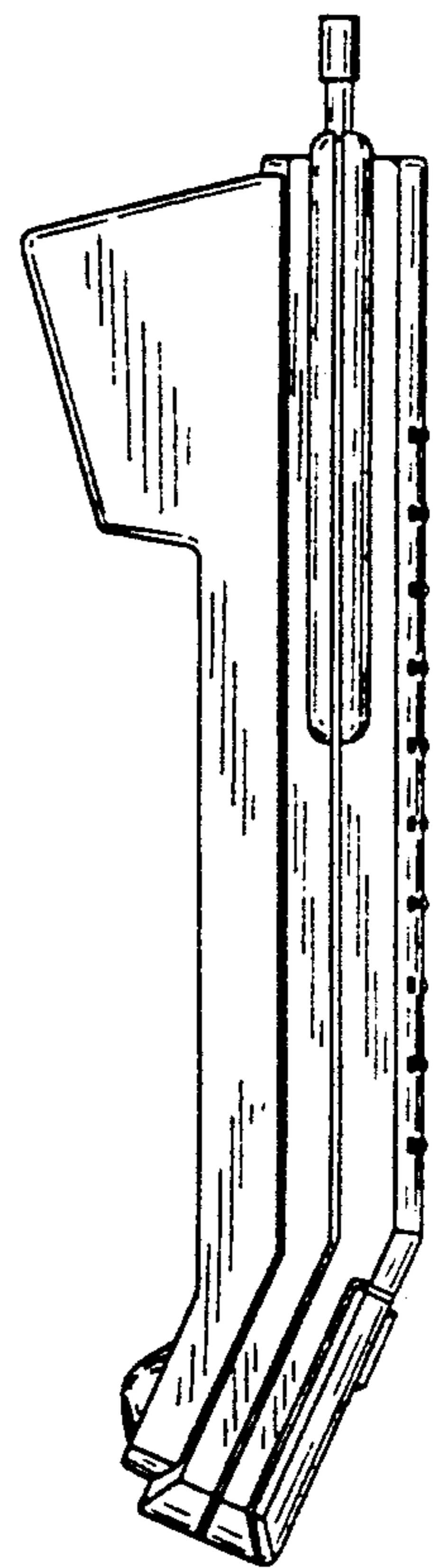

FIG. 8

