

[54] **FACSIMILE MACHINE**

[75] **Inventor: Eiji Nakajima, Tokyo, Japan**
[73] **Assignee: Tamura Electric Works, Ltd., Tokyo, Japan**
[**] **Term: 14 Years**
[21] **Appl. No.: 483,539**
[22] **Filed: Feb. 22, 1990**

[30] **Foreign Application Priority Data**

Aug. 31, 1989 [JP] Japan 1-31734
[52] **U.S. Cl. D14/118**
[58] **Field of Search D14/107, 109, 118, 124, D14/217, 299; D18/36-37; 358/400-401**

[56] **References Cited**

U.S. PATENT DOCUMENTS

D. 304,182 10/1989 Takahashi D14/118
D. 304,723 11/1989 Tsutomu D14/118
D. 312,252 11/1990 Nishio et al. D14/118

OTHER PUBLICATIONS

OPD, Jul. 1989, p. 78, Bottom left—Toshiba facsimile.

Primary Examiner—Theodore M. Shooman
Attorney, Agent, or Firm—Blakely, Sokoloff, Taylor & Zafman

[57] **CLAIM**

The ornamental design for a facsimile machine, as shown and described.

DESCRIPTION

FIG. 1 is a top, front and right side perspective view of a facsimile machine showing our new design, with the handset spaced apart from the console for clarity of illustration;

FIG. 2 is a front elevational view thereof;

FIG. 3 is a top plan view thereof;

FIG. 4 is a bottom plan view thereof;

FIG. 5 is a rear elevational view thereof;

FIG. 6 is a left side elevational view thereof; and

FIG. 7 is a right side elevational view thereof.

The cord being broken away in all Figures for ease of illustration.

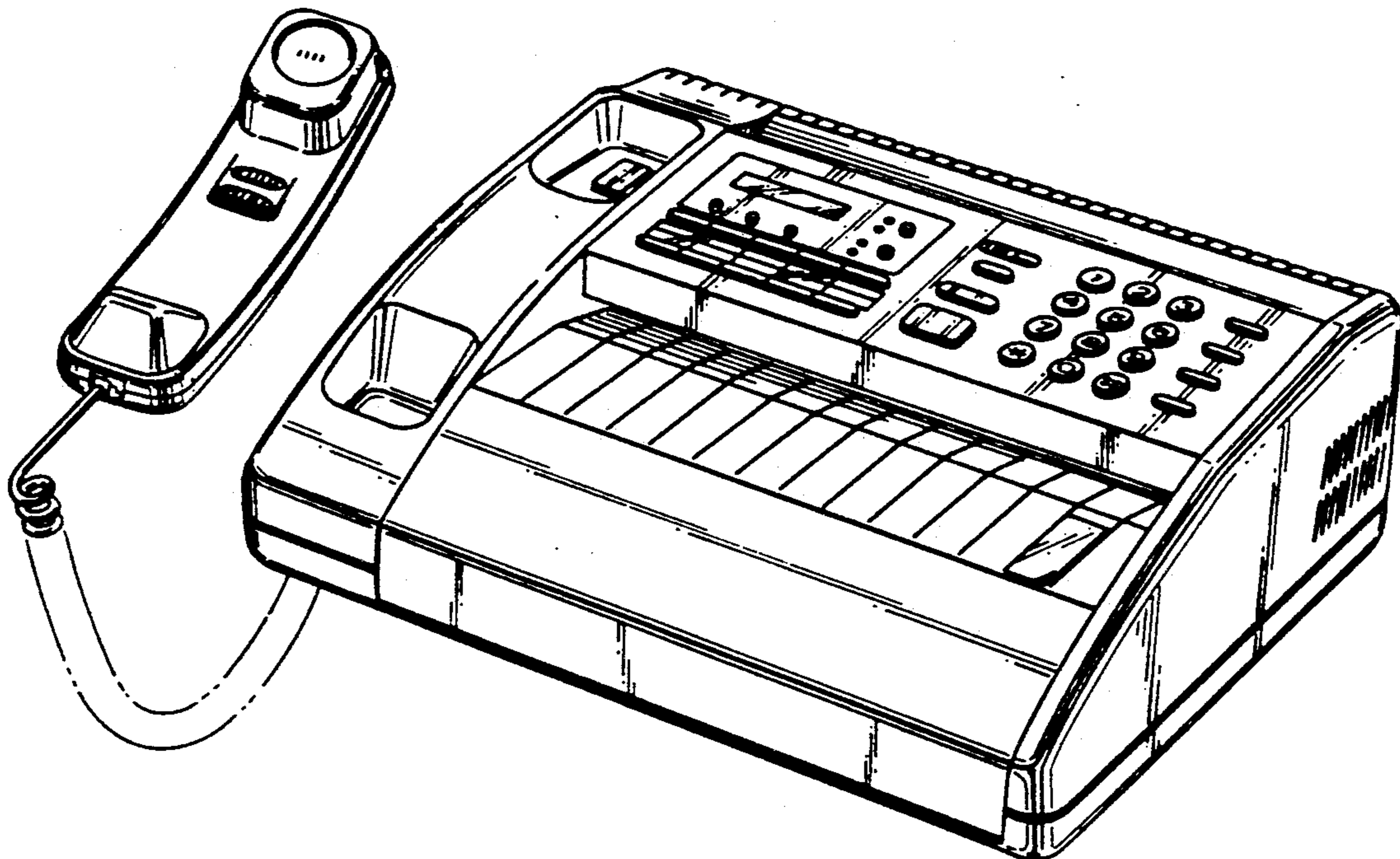

FIG. 1

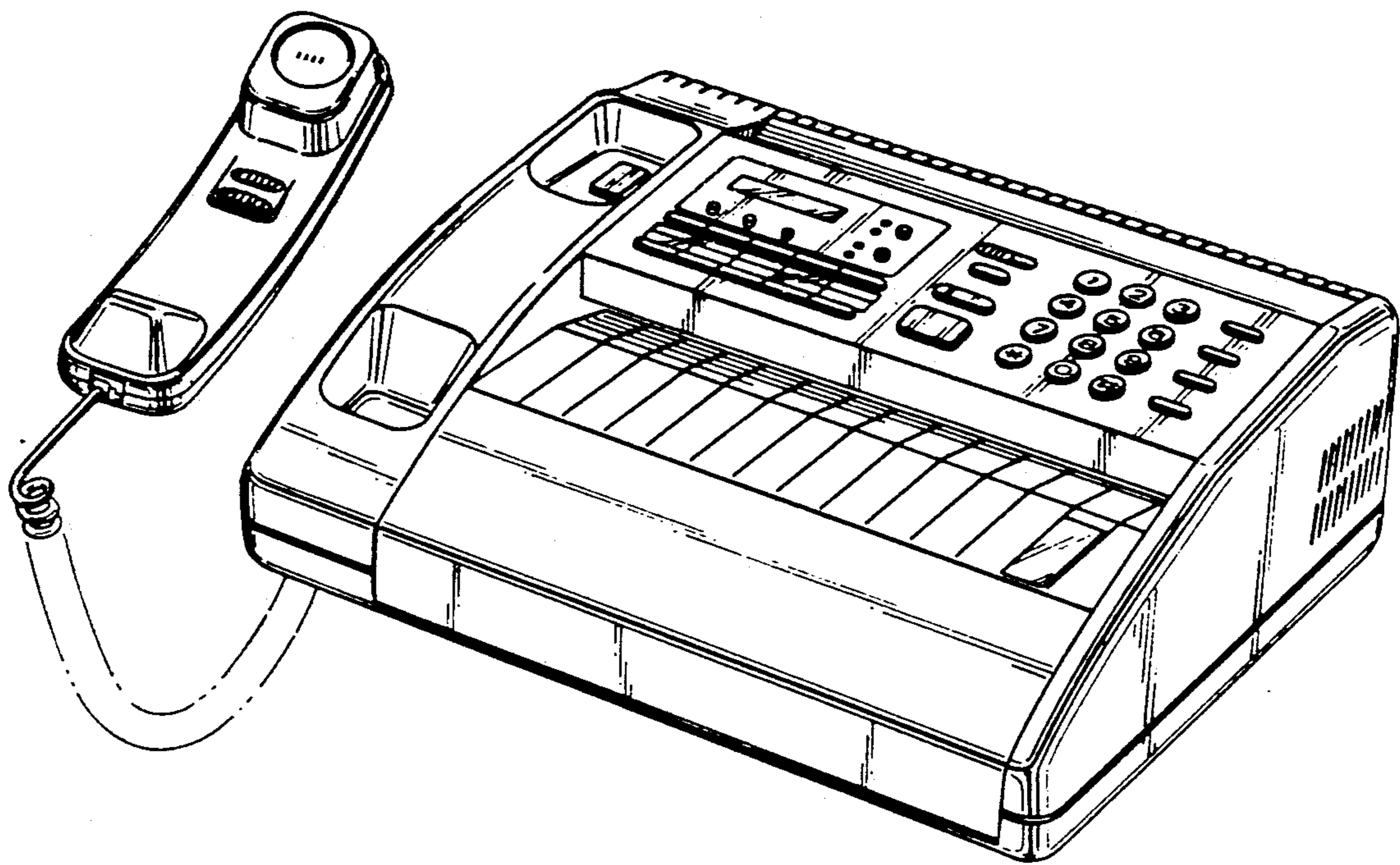

FIG. 2

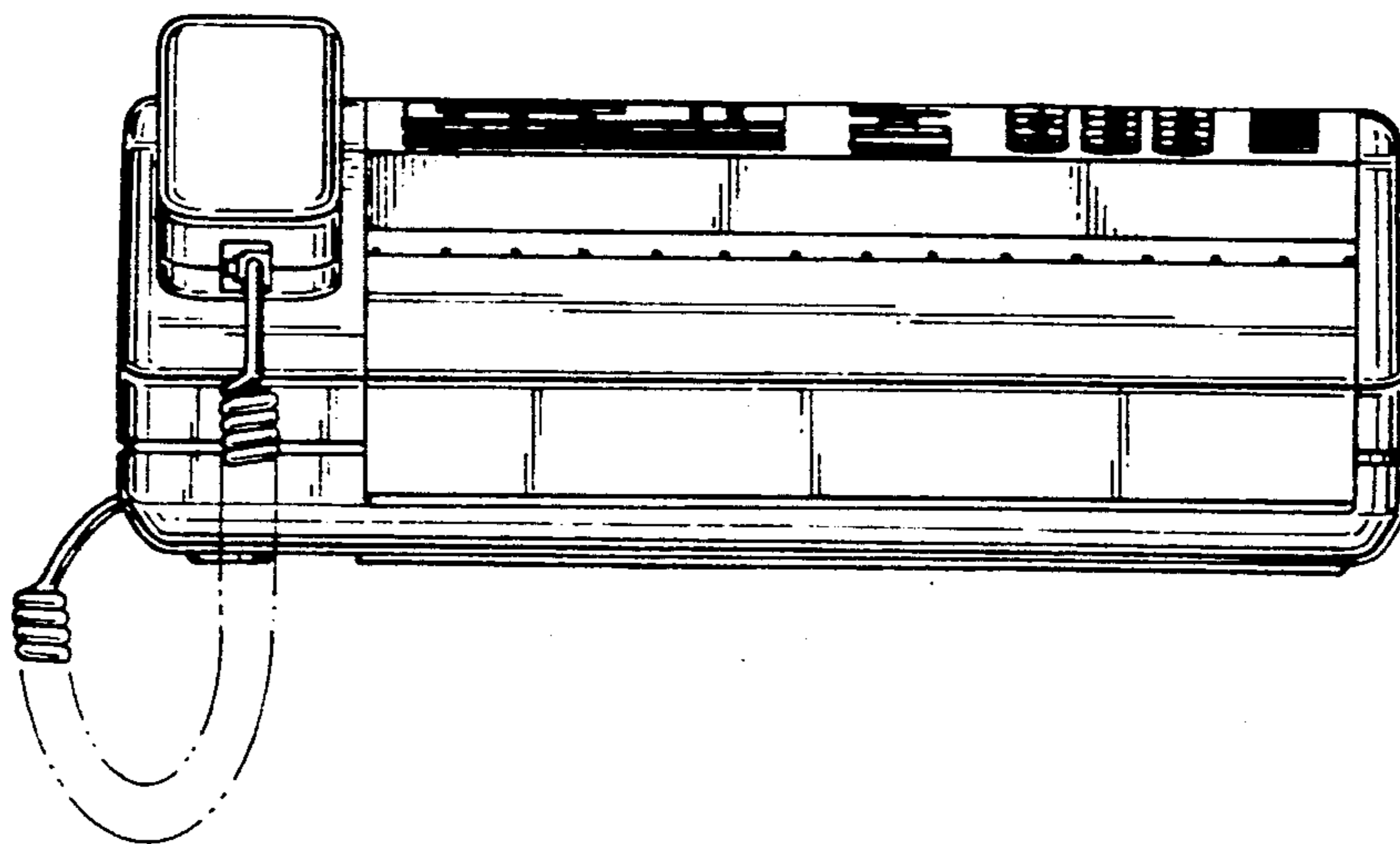

FIG. 3

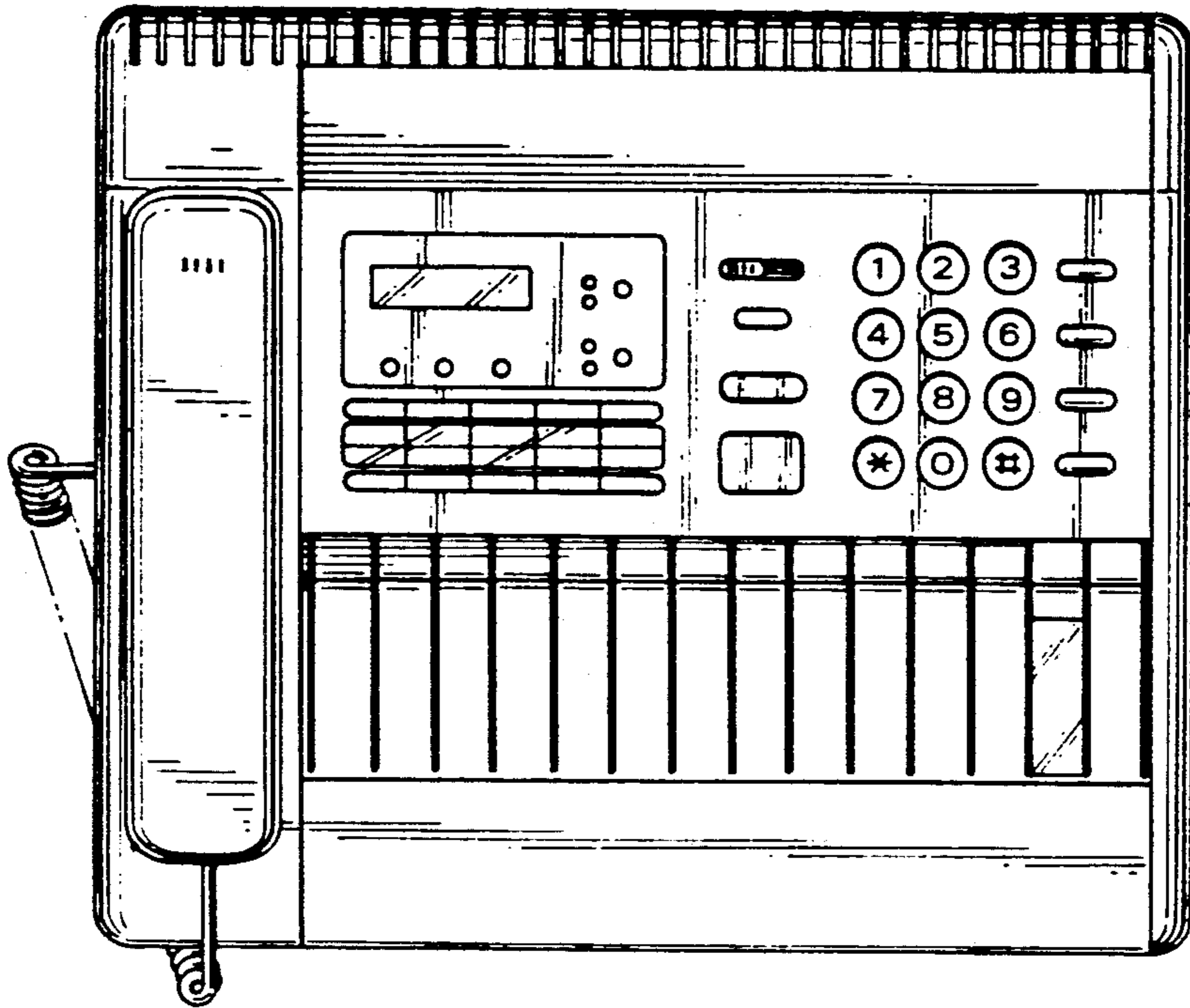

FIG. 4

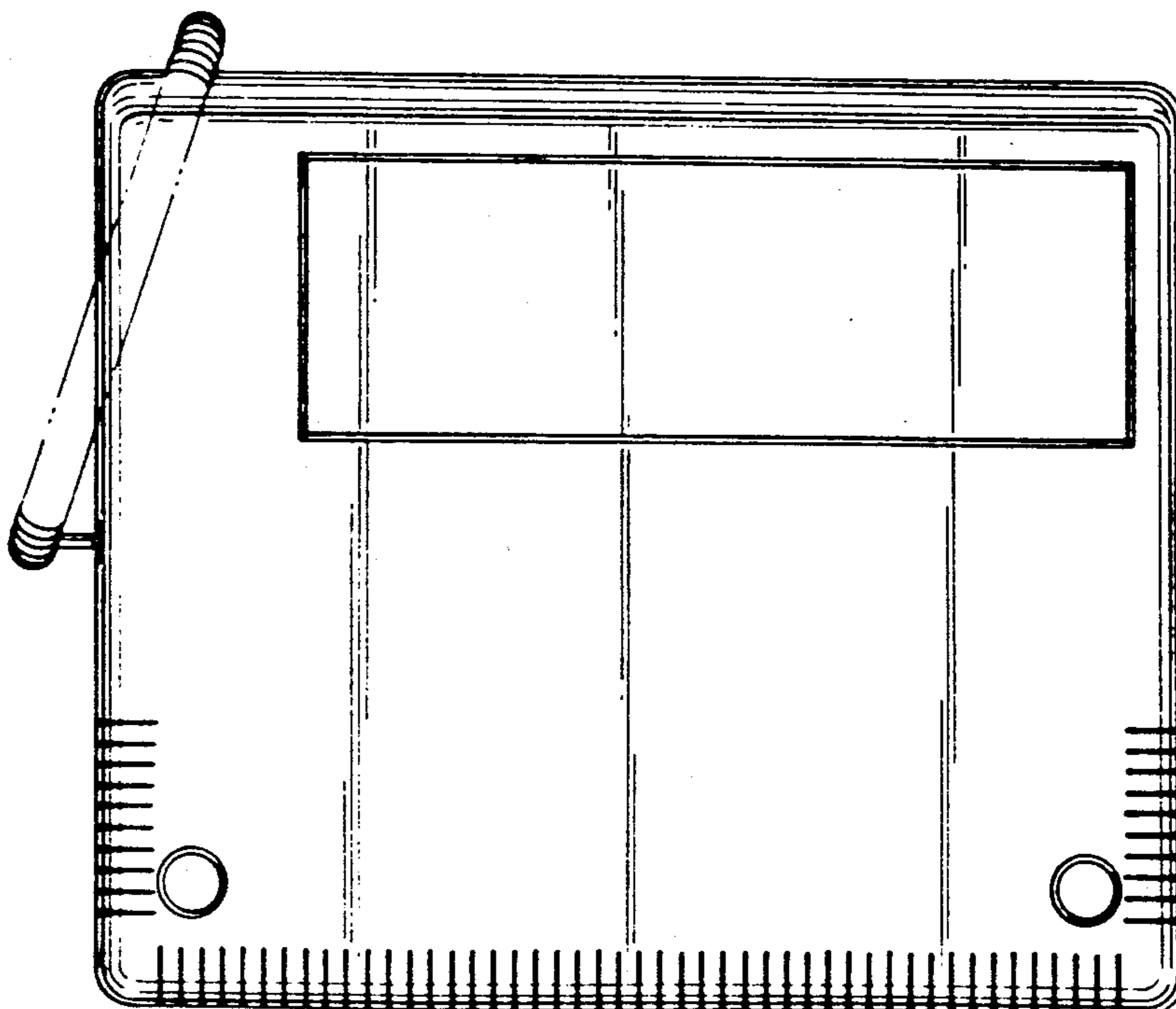

FIG.5

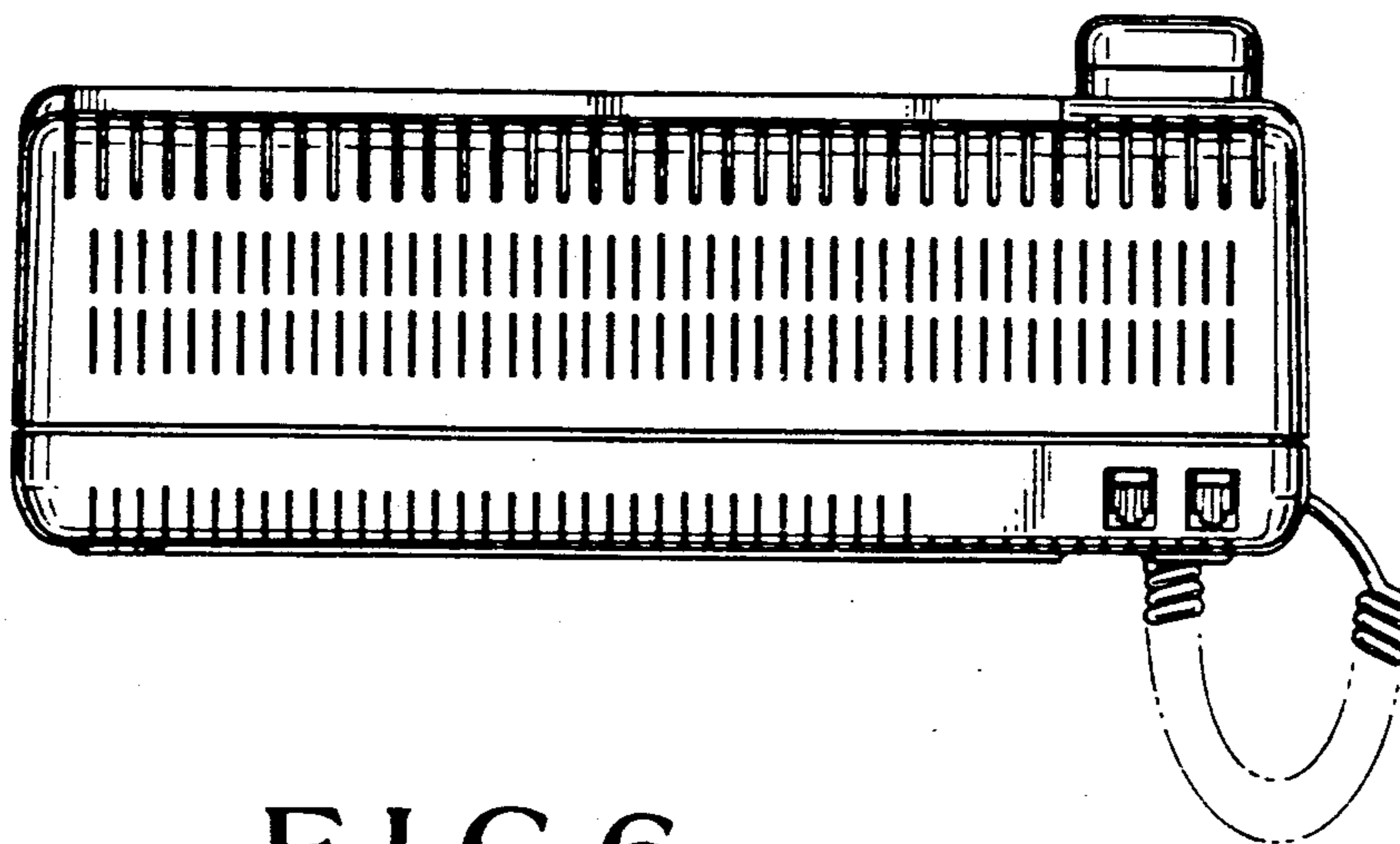

FIG.6

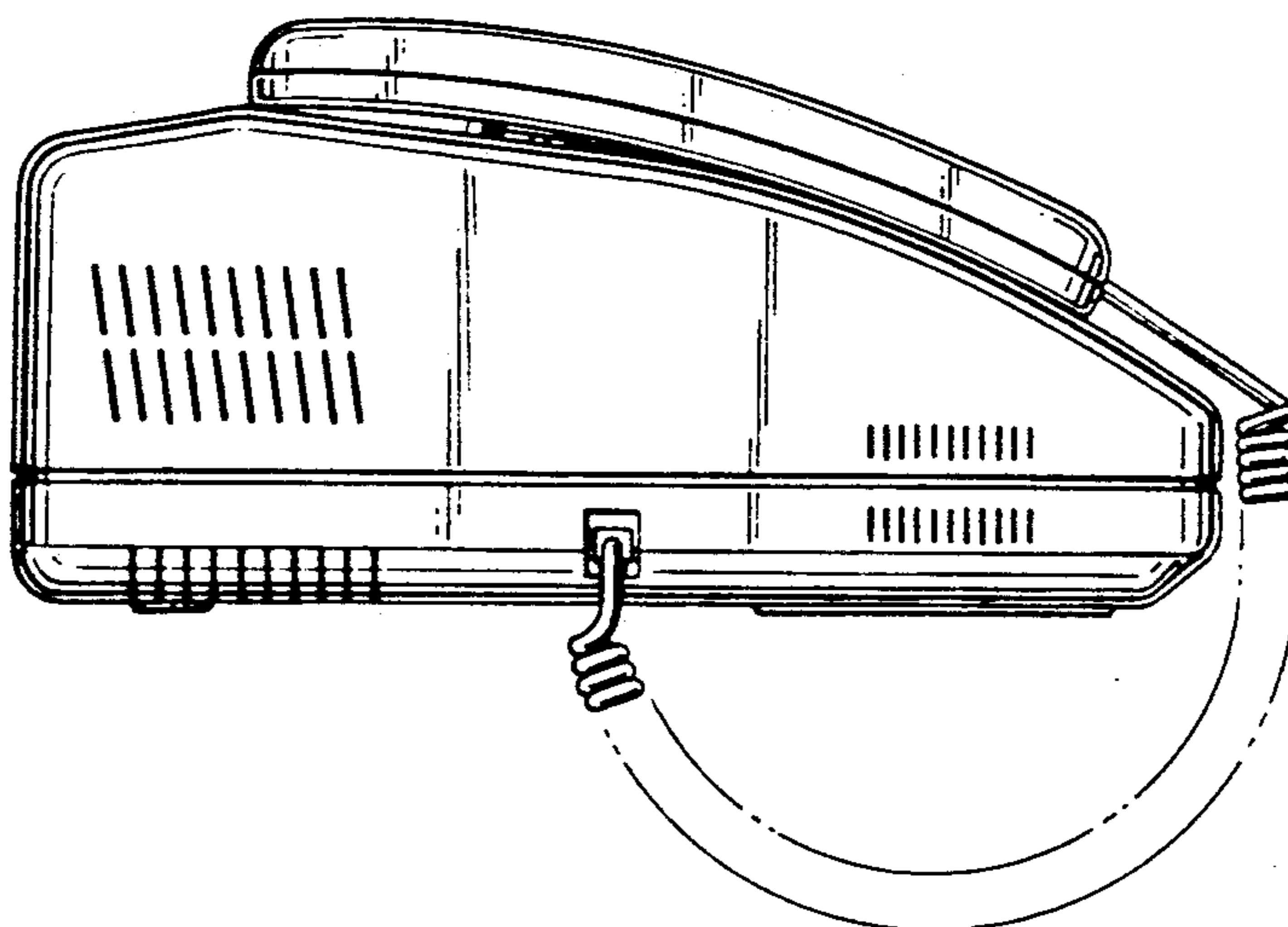

FIG.7

