

[54] WRISTWATCH

[76] Inventor: Benjamin E. Woomer, 1597 E. 30th St., Cleveland, Ohio 44114

[\*\*] Term: 14 Years

[21] Appl. No.: 273,510

[22] Filed: Nov. 21, 1988

[52] U.S. Cl. .... D10/39

[58] Field of Search ..... D10/30-33, D10/38, 39, 122-126; 368/223-232, 276-278, 281, 292-296

[56] References Cited

U.S. PATENT DOCUMENTS

D. 145,831	10/1946	Arpels	.....	D10/32
D. 195,421	6/1963	Huguenin	.....	D10/39
D. 260,615	9/1981	Maconi	.....	D10/32
D. 289,381	4/1987	Schneider	.....	D10/32
D. 310,034	8/1990	Braun et al.	.....	D10/38 X
D. 317,265	6/1991	Giolla et al.	.....	D10/39

OTHER PUBLICATIONS

Swiss Watch & Jewelry Journal, Watch No. E18.52, 2/1977, p. 223.

European Journal, Watch below (directly) Label, 4/1986, p. 232.

Primary Examiner—Bruce W. Dunkins

Assistant Examiner—Antoine D. Davis

Attorney, Agent, or Firm—D. Peter Hochberg; Mark Kusner; Louis J. Weisz

[57] CLAIM

The ornamental design for a wristwatch, as shown and described.

DESCRIPTION

FIG. 1 is a top plan view of a wristwatch showing my new design, the broken line showing of a partial strap is environmental only and forms no part of the claimed design thereof;

FIG. 2 is a front elevational view;

FIG. 3 is a bottom plan view;

FIG. 4 is a rear elevational view;

FIG. 5 is a left side elevational view; and

FIG. 6 is a right side elevational view thereof.

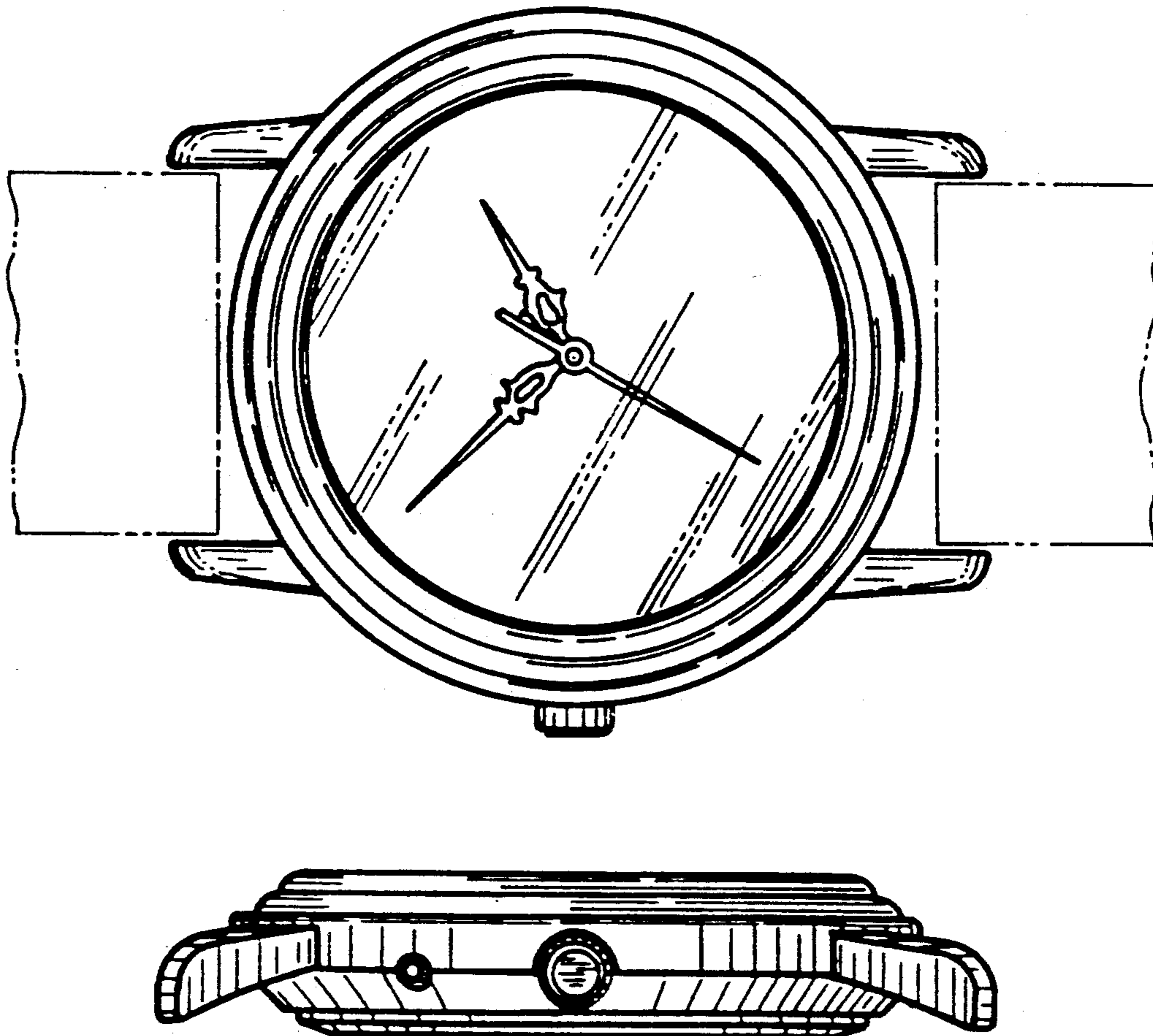

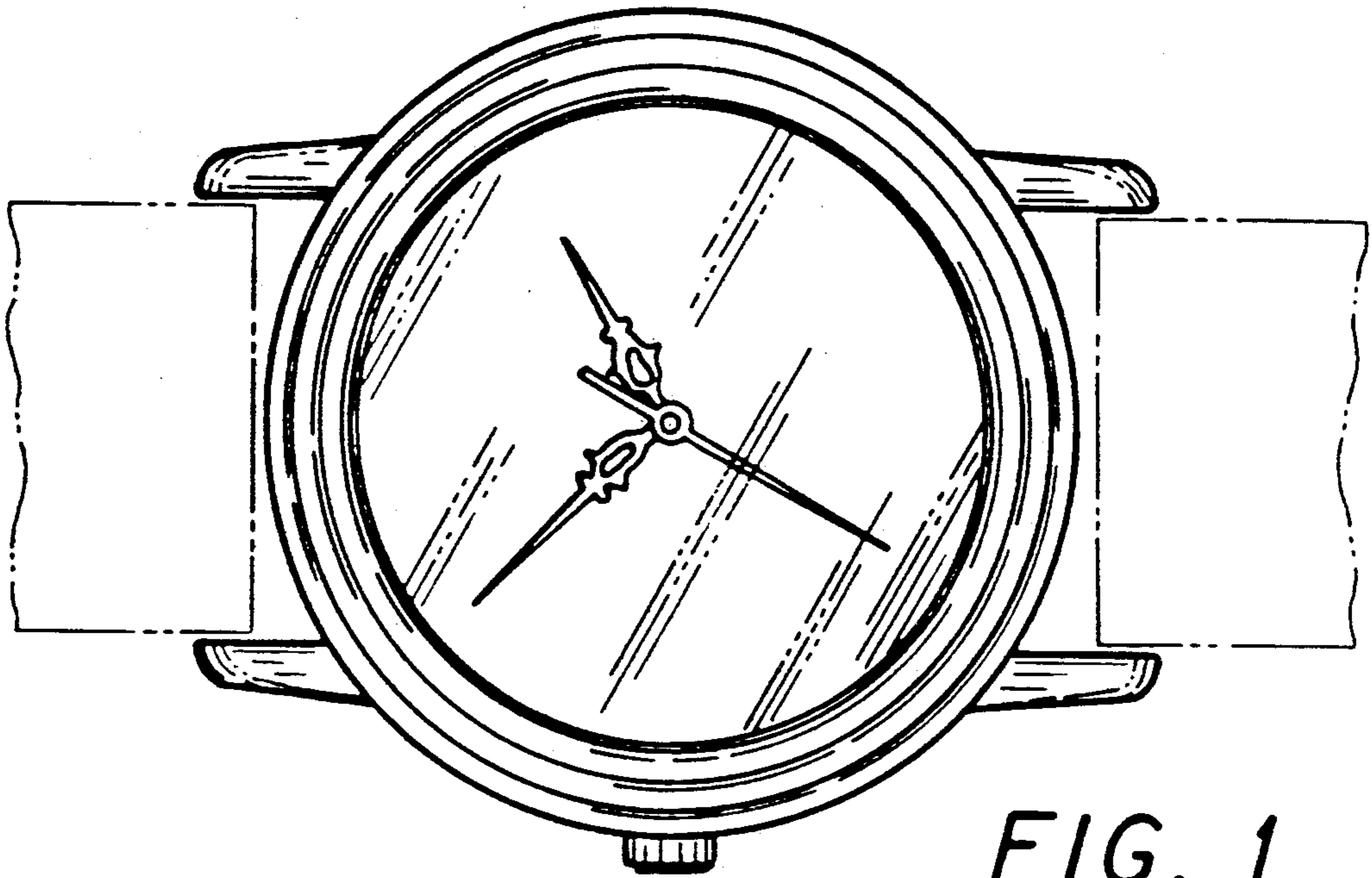

FIG. 1

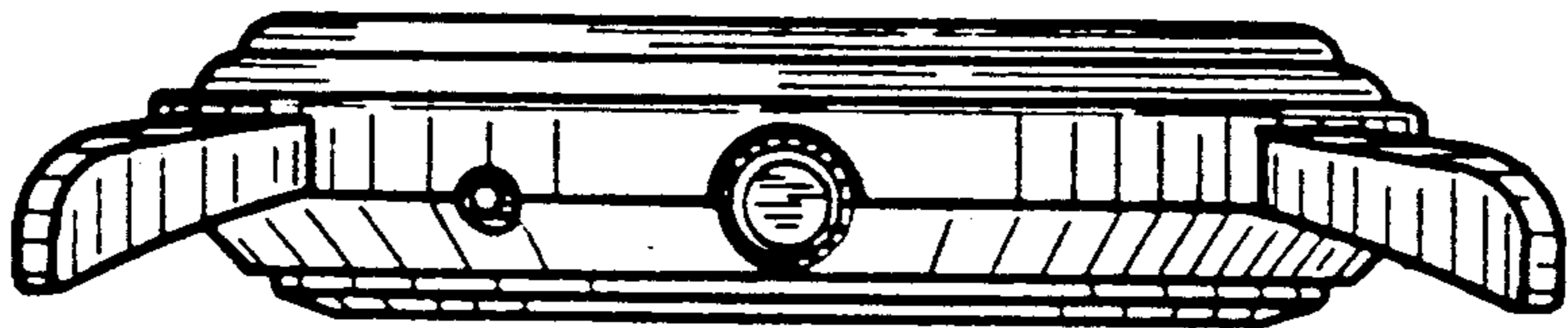

FIG. 2

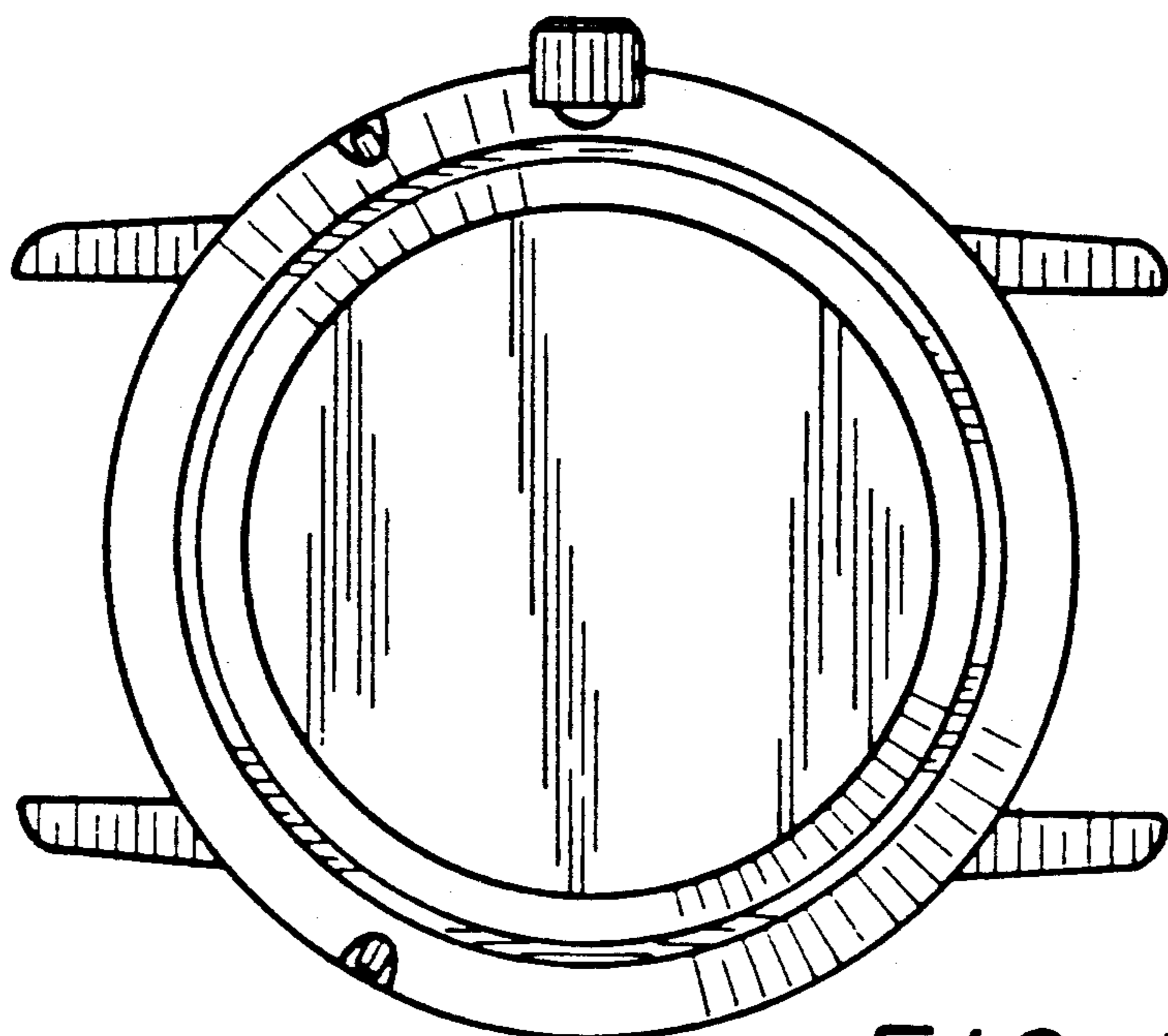

FIG. 3

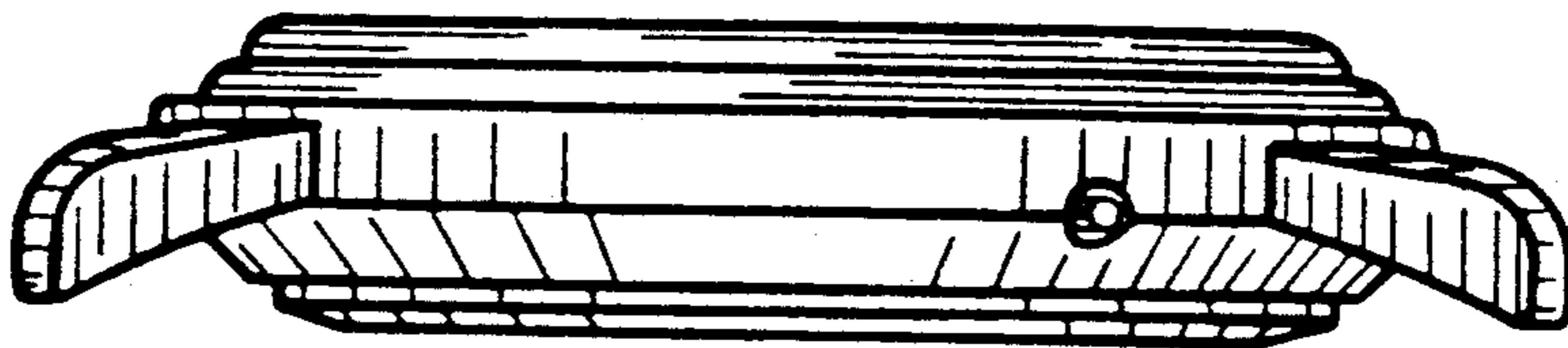

FIG. 4

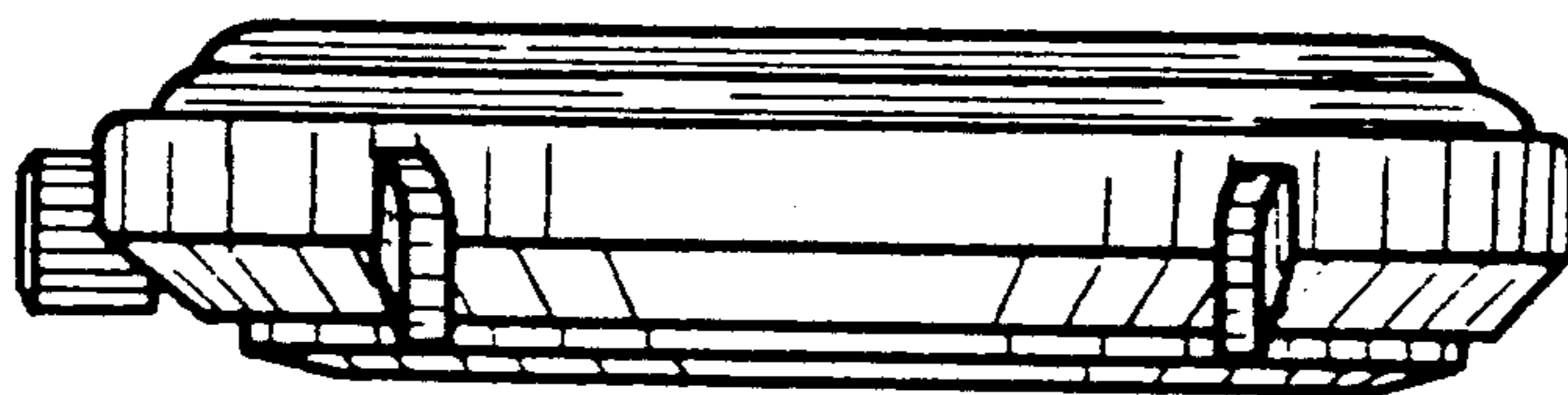

FIG. 5

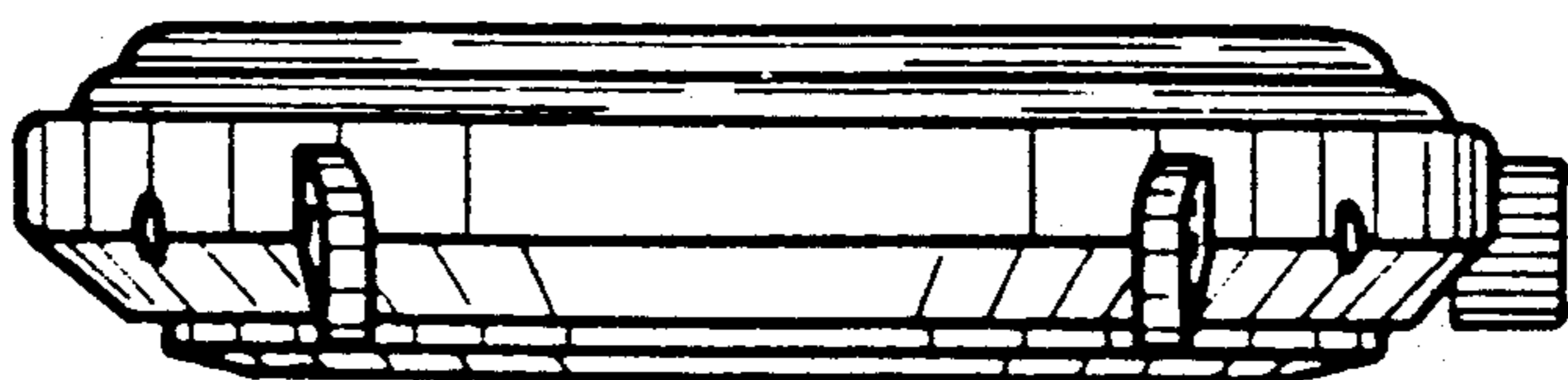

FIG. 6