

[54] COMPARTMENTED CONTAINER

[76] Inventor: Ernest M. Porter, 64 Oxford Street, Toronto, Ontario, M5T 1P1, Canada

[**] Term: 14 Years

[21] Appl. No.: 438,880

[22] Filed: Dec. 18, 1989

[52] U.S. Cl. D9/341

[58] Field of Search D9/341-346, D9/414, 430, 431, 455; 229/120.23, 120.12, 108, 110, 8; 206/44 R, 457

[56] References Cited

U.S. PATENT DOCUMENTS

- D. 41,027 12/1910 Krebs D7/558
- 1,649,088 11/1927 Tinsley 229/108 X
- 2,291,265 7/1942 Viglietta 229/120.23 X
- 2,685,366 8/1954 Jenner 229/120.23 X
- 4,172,549 10/1979 Yoshida 229/8

- 4,483,317 11/1984 Masters D7/558 X
- 4,754,916 7/1988 Knight, Jr. 229/120.23 X

Primary Examiner—Bernard Ansher
Assistant Examiner—Prabhakar Deshmukh

[57] CLAIM

The ornamental design for a compartmented container, as shown and described.

DESCRIPTION

FIG. 1 is a perspective view of a compartmented container showing my new design;
 FIG. 2 is a perspective view thereof; showing undisclosed sides in FIG. 1;
 FIG. 3 is a left side elevation thereof;
 FIG. 4 is a right side elevational thereof;
 FIG. 5 is a front elevation thereof;
 FIG. 6 is a rear elevation thereof;
 FIG. 7 is a top plan view thereof; and
 FIG. 8 is a bottom plan view thereof.

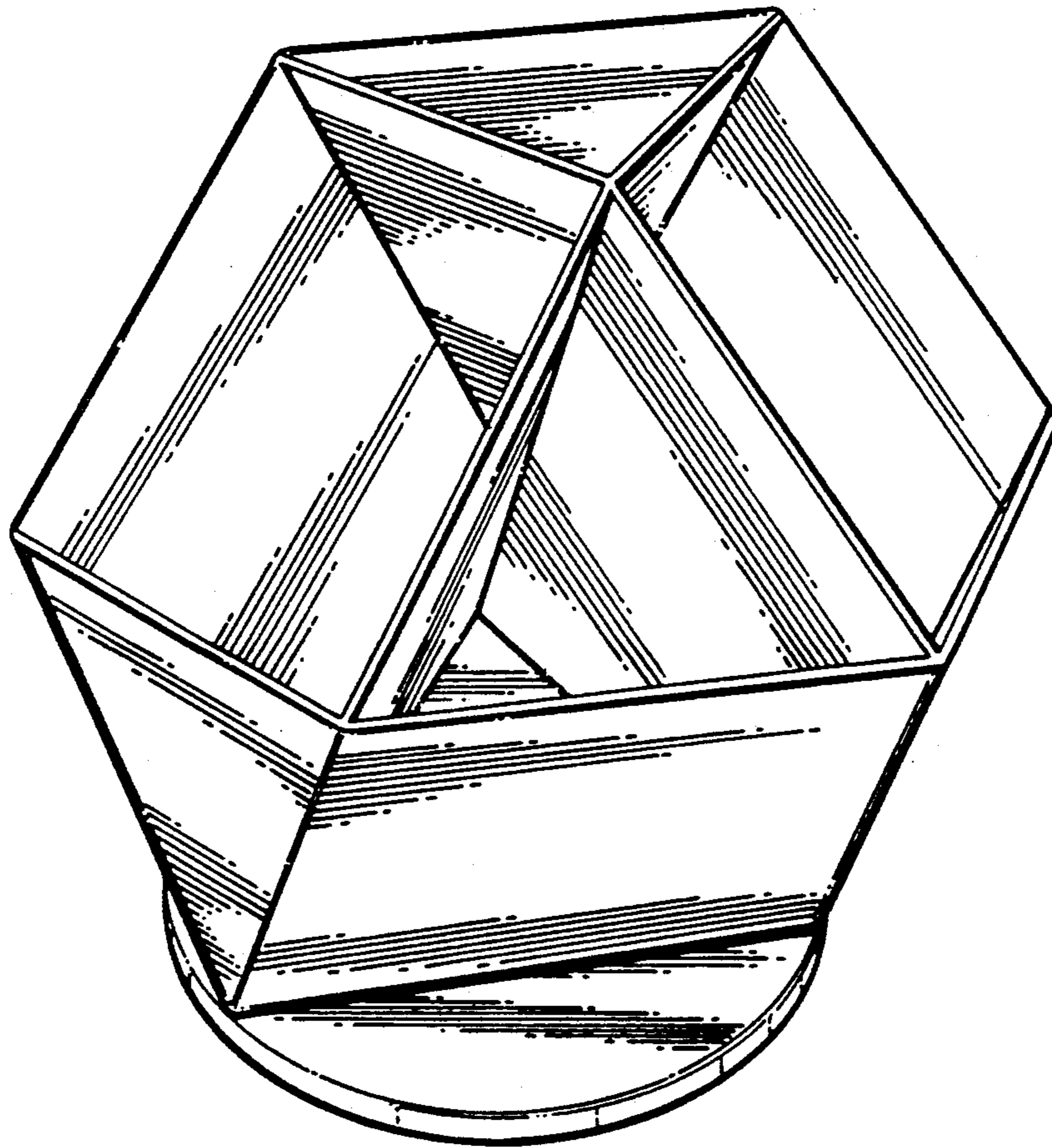

FIG. 1.

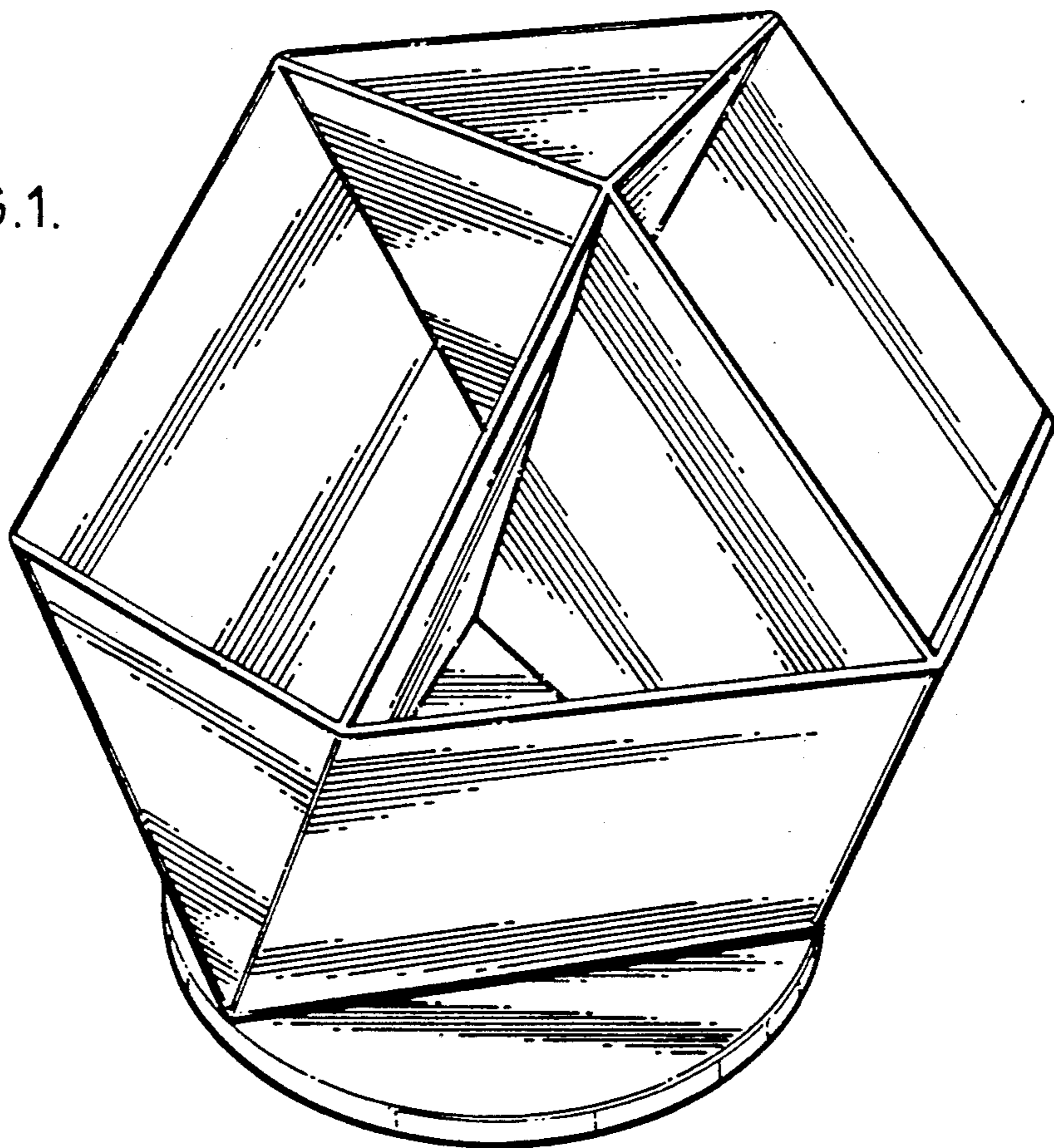

FIG. 2.

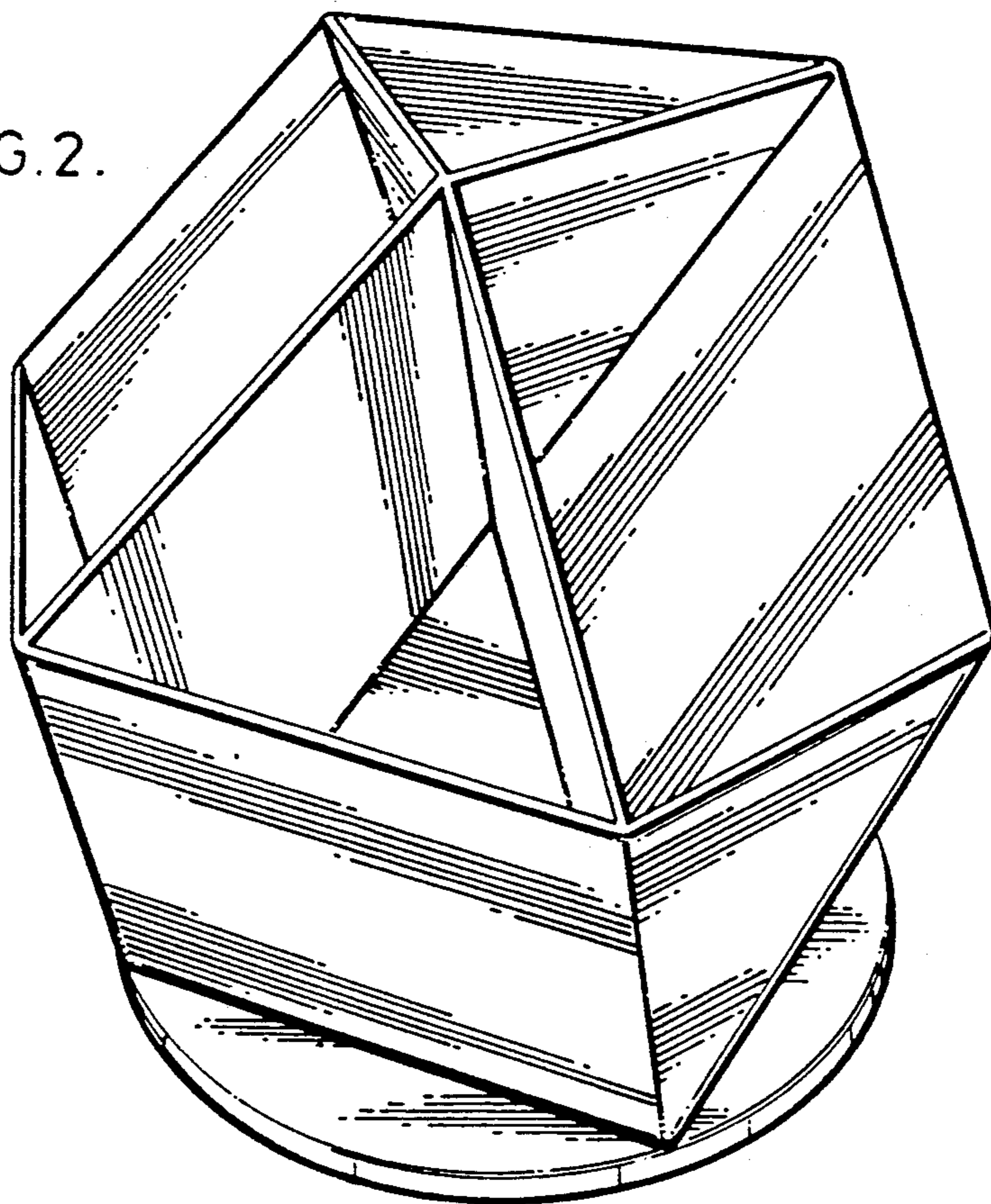

FIG. 3.

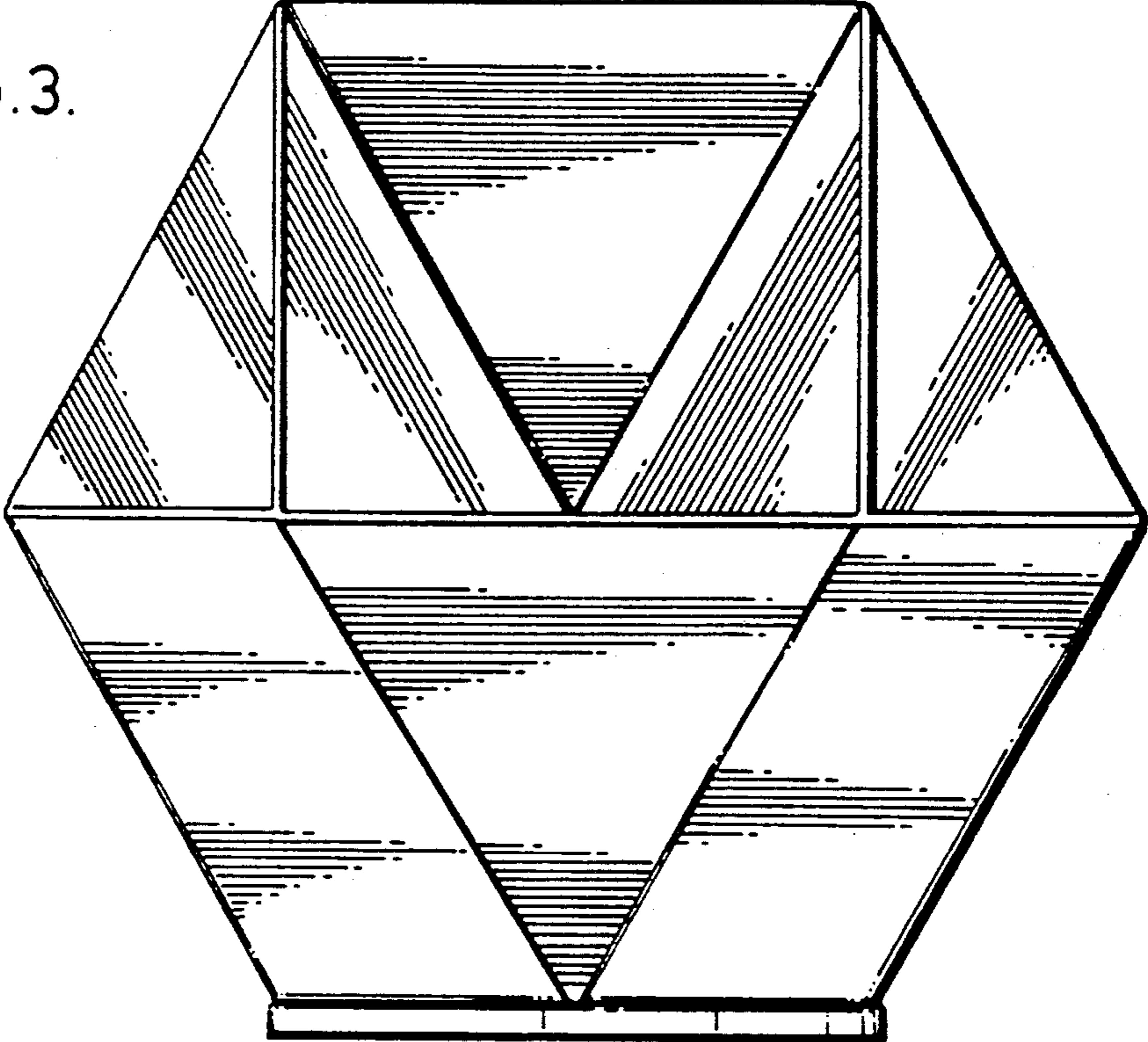

FIG. 4.

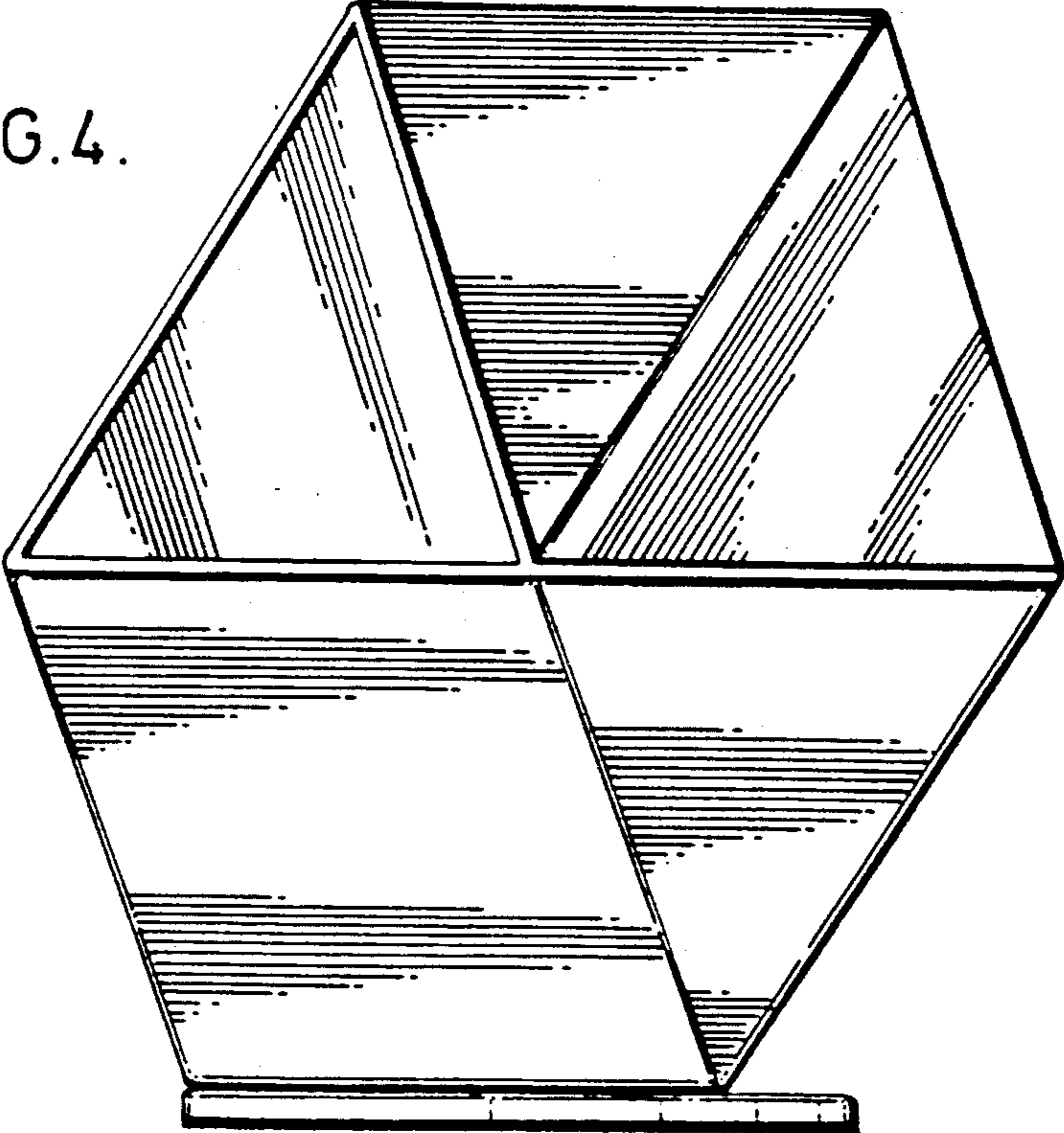

FIG. 5.

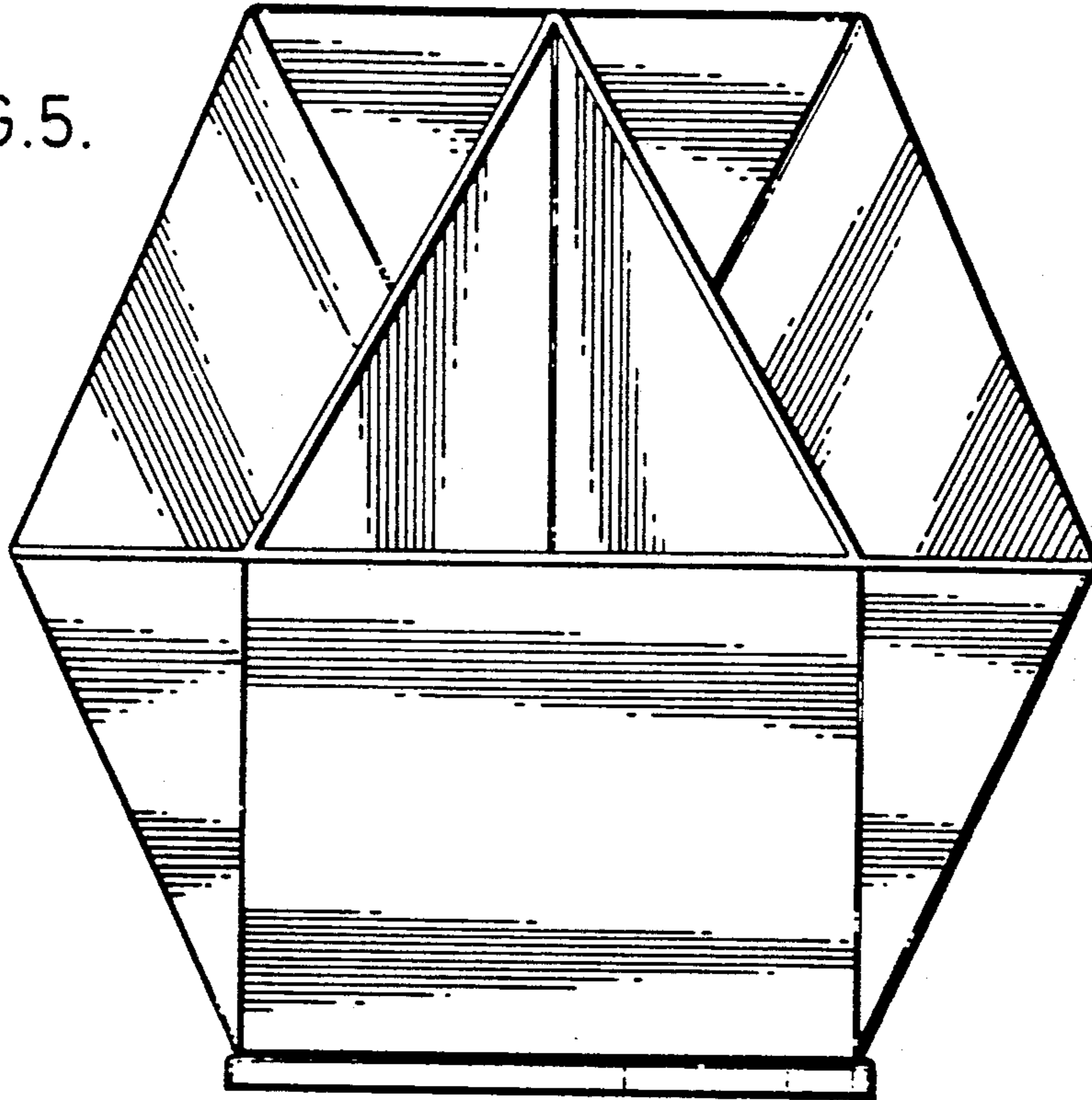

FIG. 6.

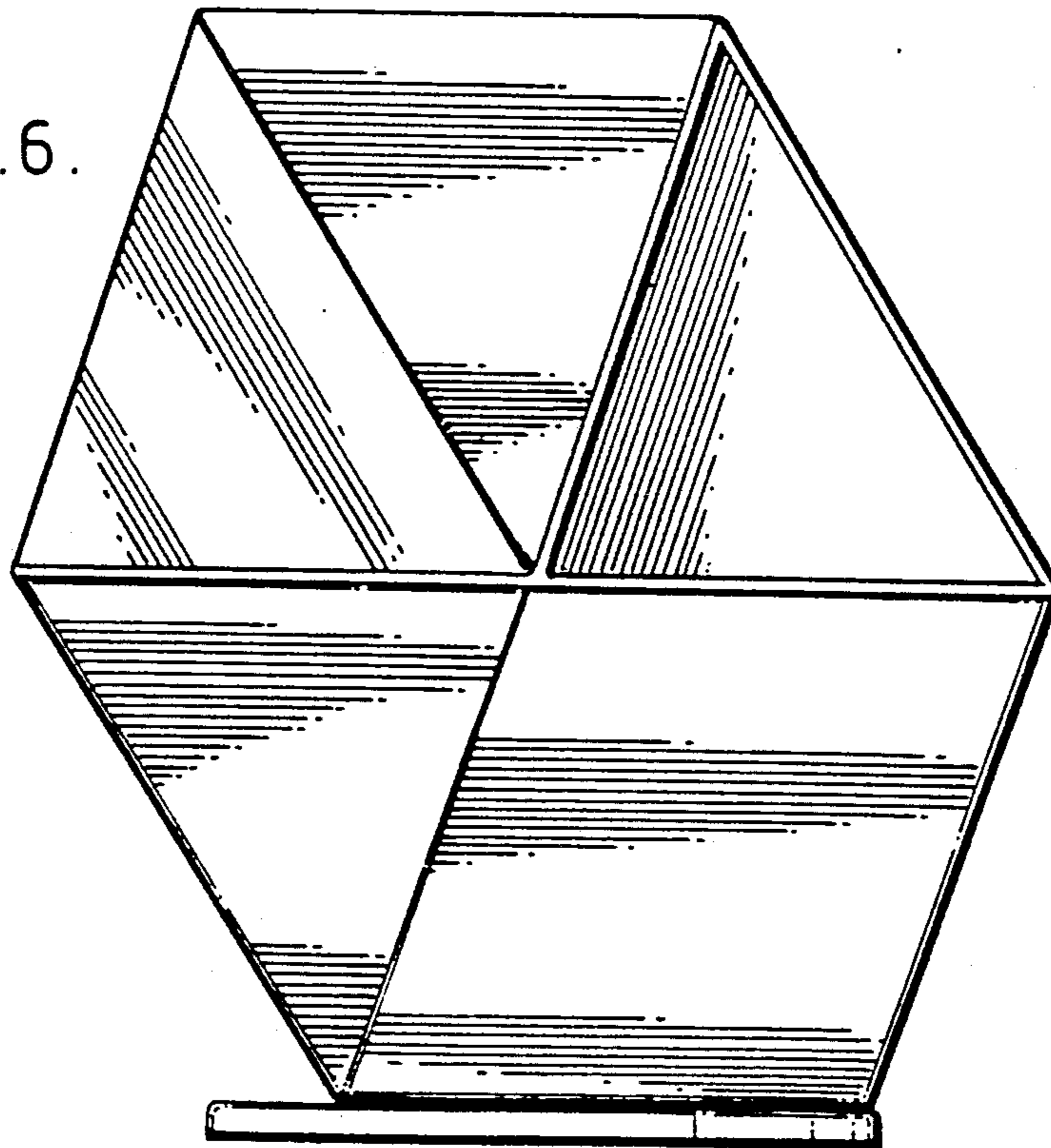

FIG. 7.

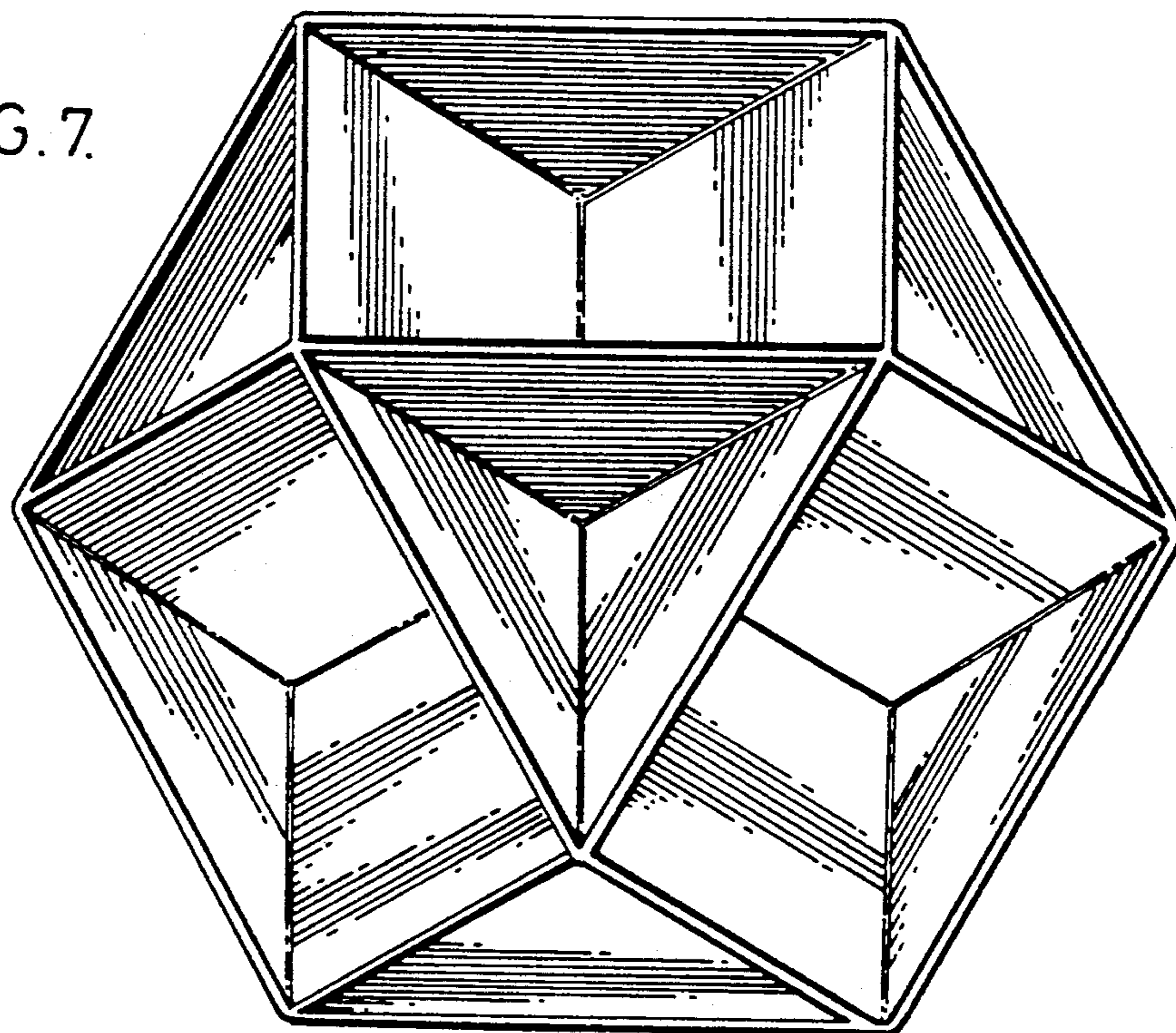

FIG. 8.

