

[54] KEYLESS LOCK

[75] Inventors: John F. Ginther, North Wales; Kim E. Burrichter, Upper Darby; Charles P. Coggins, Downingtown; David C. Guthrie, Chester Springs; Mark K. Lucchi, West Chester, all of Pa.

[73] Assignee: Allister Manufacturing Company, Inc., West Chester, Pa.

[**] Term: 14 Years

[21] Appl. No.: 419,632

[22] Filed: Oct. 11, 1989

[52] U.S. Cl. D8/330

[58] Field of Search D8/330-331, D8/332, 343, 346; 70/91, 101, 277, 286, 156

[56] References Cited

U.S. PATENT DOCUMENTS

- D. 290,442 6/1987 Floyd et al. D8/330
- D. 305,861 2/1990 Kautt D8/330
- 3,353,383 11/1967 Fish 70/156 X
- 4,637,237 1/1987 Witkoski et al. D8/330 X

- 4,899,562 2/1990 Gartner et al. 70/277
- 4,956,984 9/1990 Chi-Cheng 70/277

Primary Examiner—Wallace R. Burke
Assistant Examiner—Brian N. Vinson
Attorney, Agent, or Firm—Robert Charles Beam

[57] CLAIM

The ornamental design for a keyless lock, as shown and described.

DESCRIPTION

FIG. 1 is a top, front, and right side perspective view of a keyless lock showing our new design; FIG. 2 is a front elevation view thereof; FIG. 3 is a top plan view thereof; FIG. 4 is a bottom plan view thereof; FIG. 5 is a left side elevation view thereof; FIG. 6 is a rear elevation view thereof; FIG. 7 is a right side elevational view thereof; FIG. 8 is a left side elevational view thereof, with the protective cover shown rotated to an open position, the right side being a mirror image of that shown; and FIG. 9 is a front elevational view thereof, with the protective cover shown rotated to an open position.

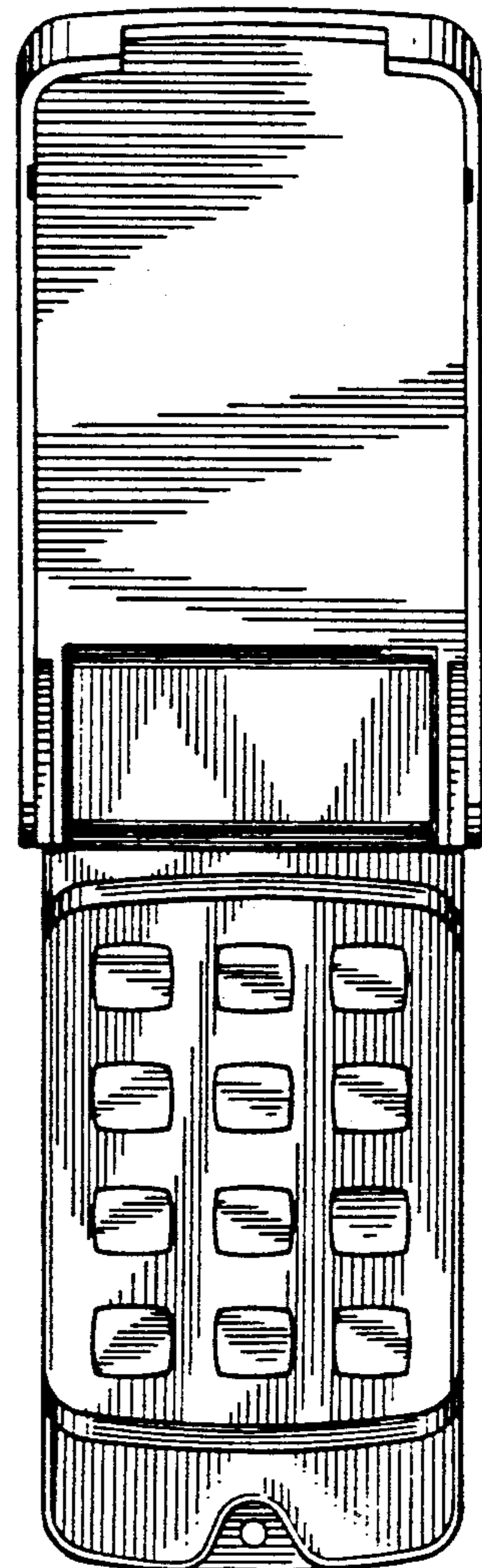
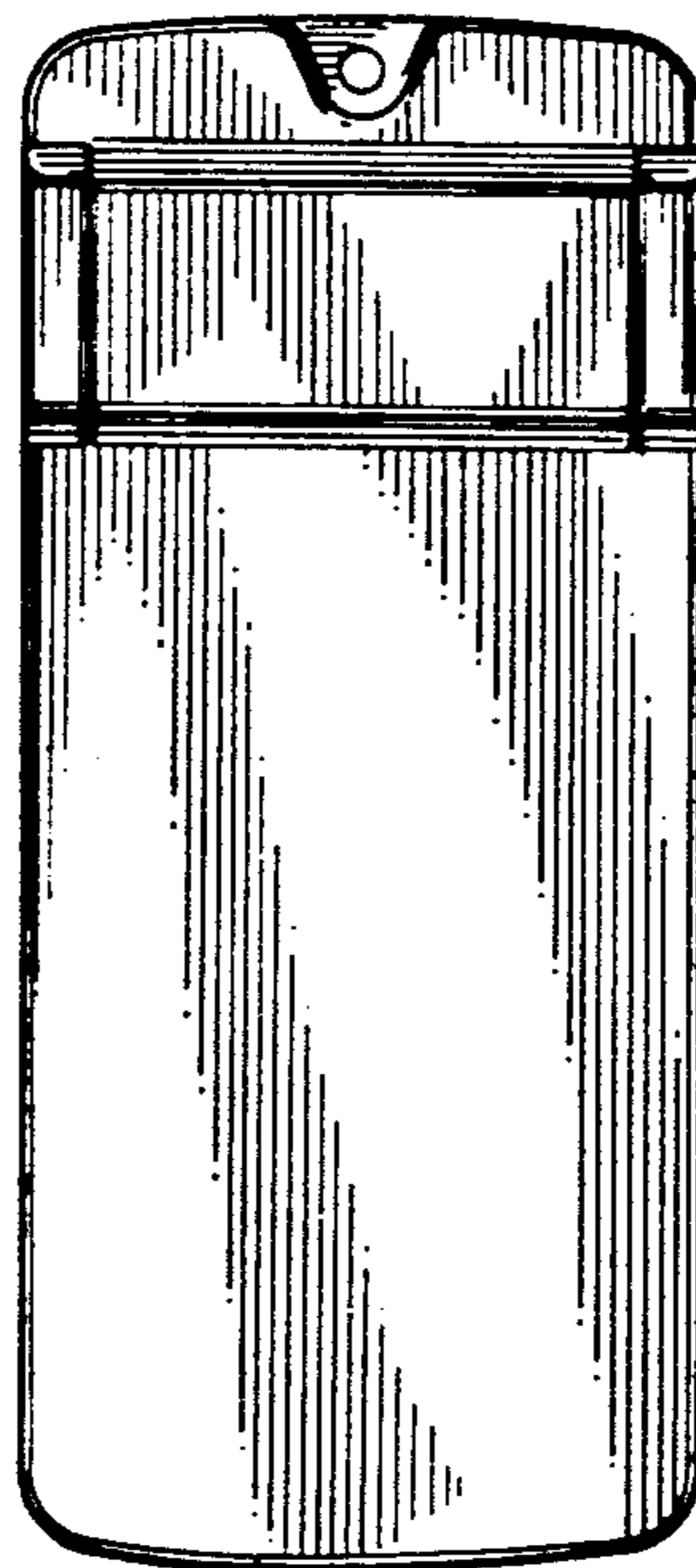
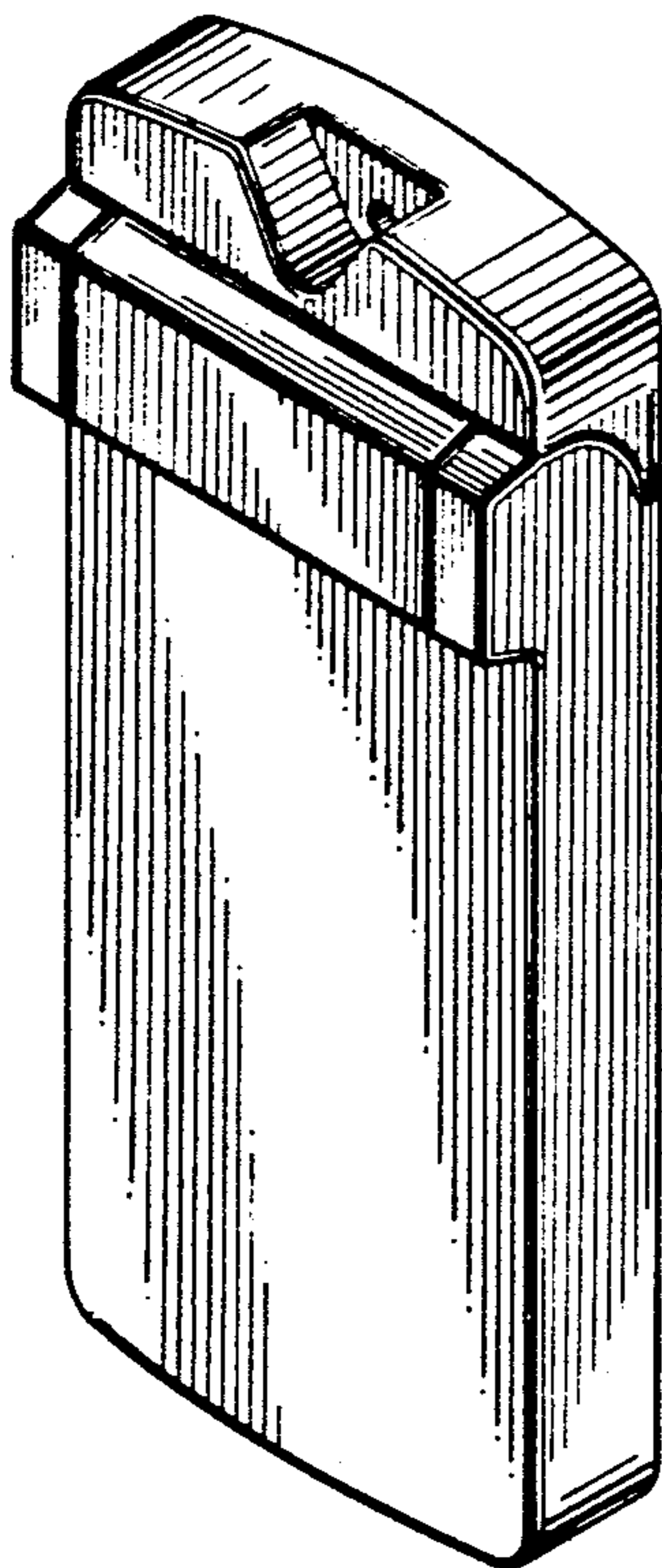

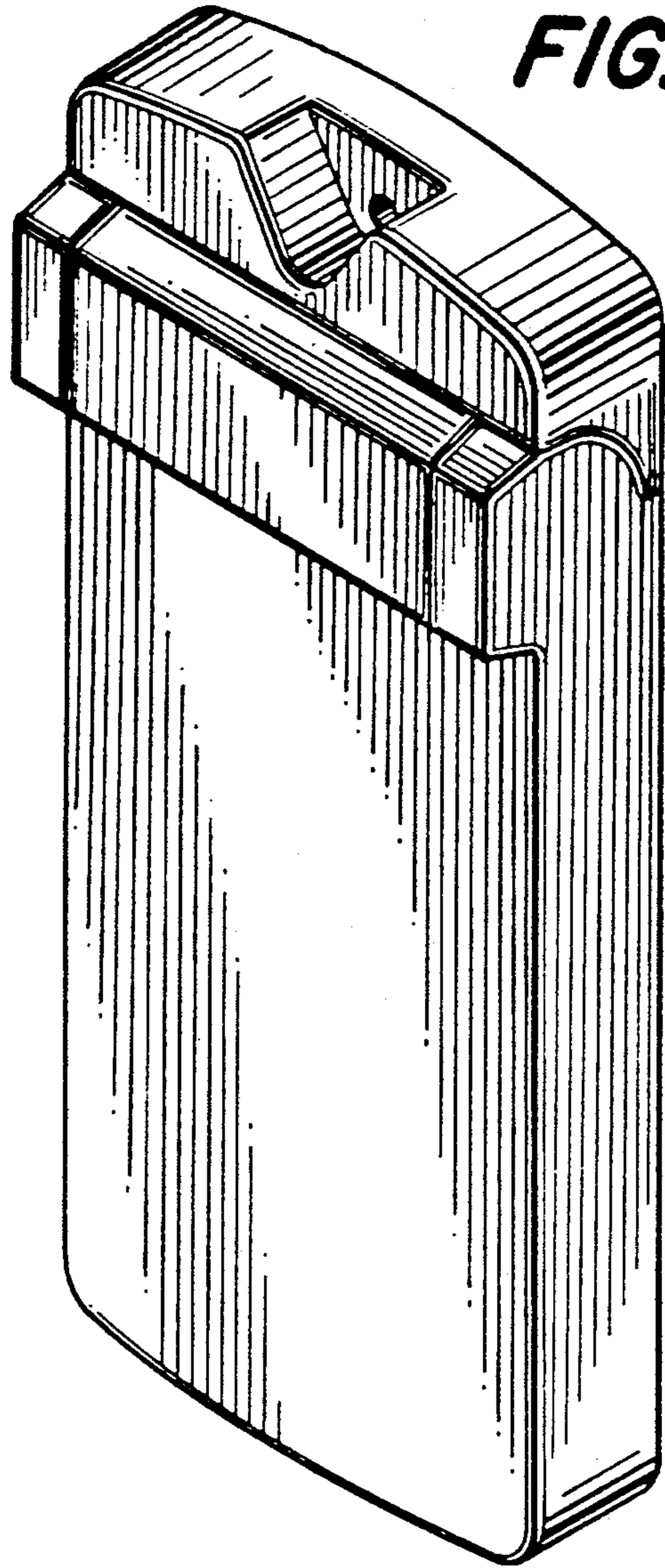

FIG. 1

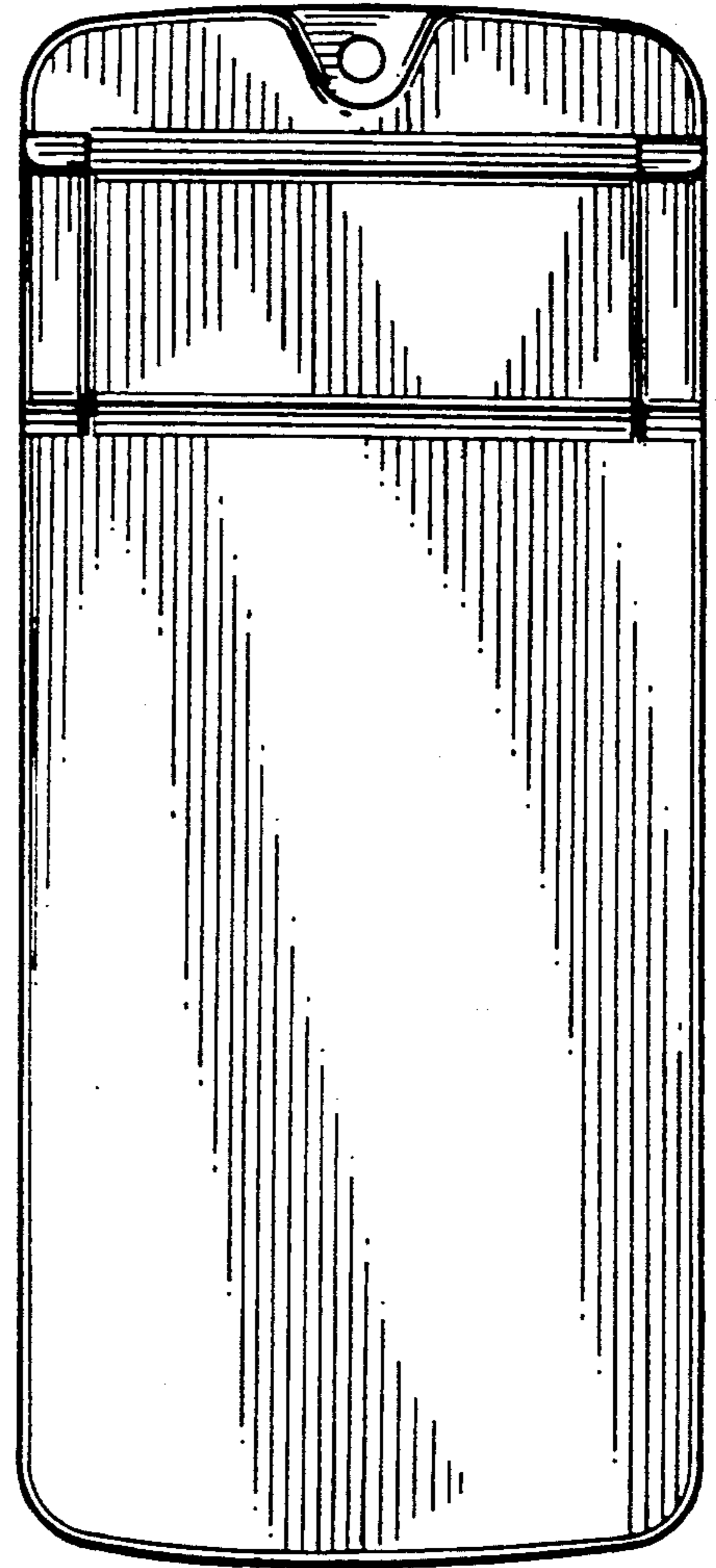

FIG. 2

FIG. 3

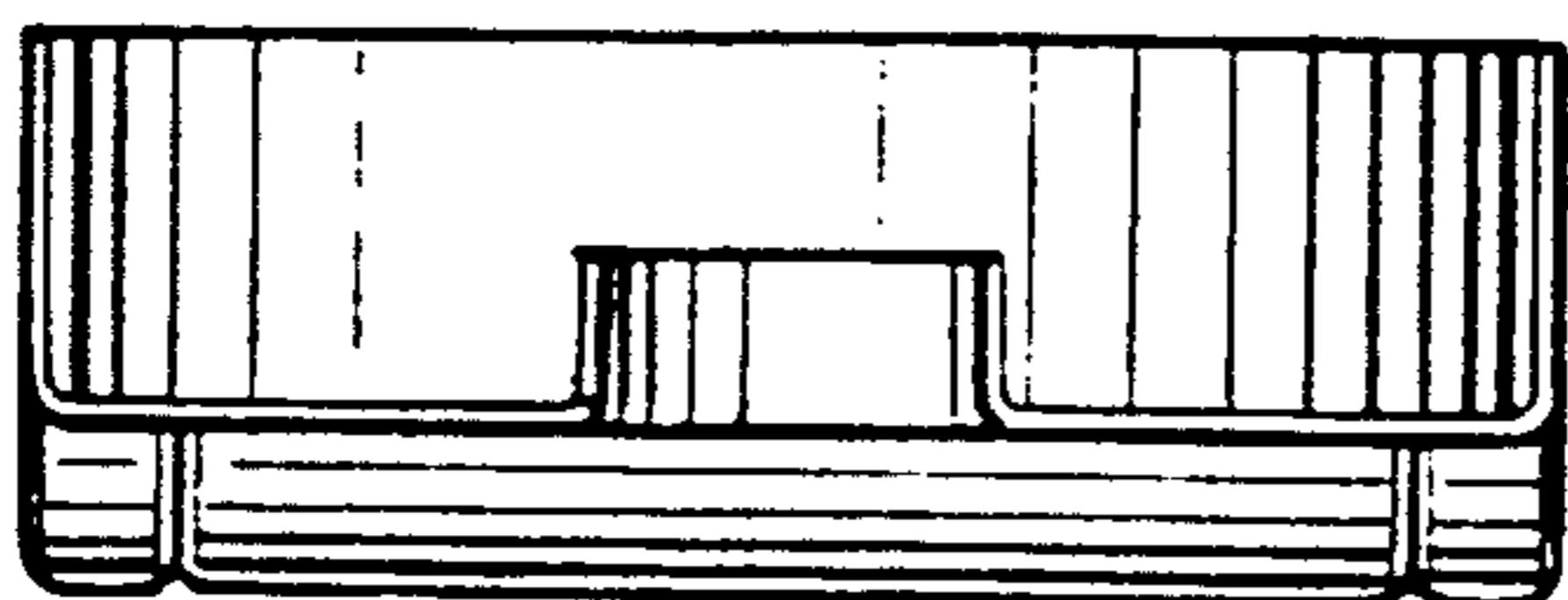

FIG. 4

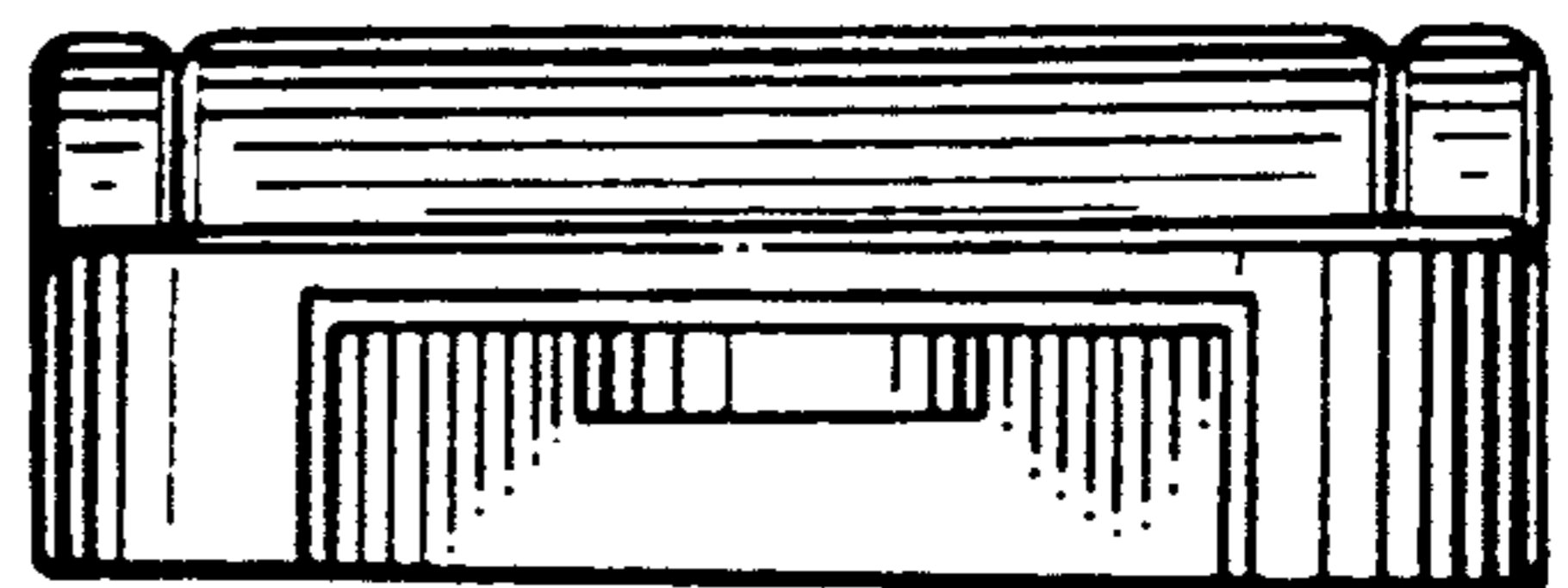

FIG. 7

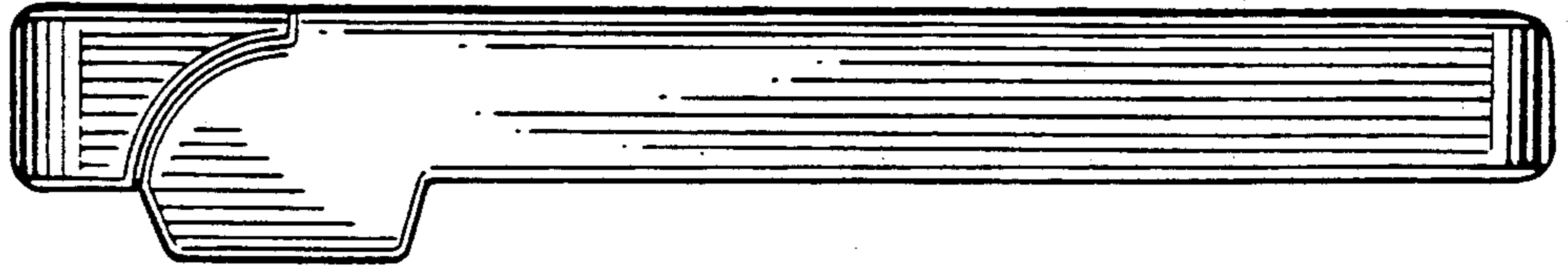

FIG. 6

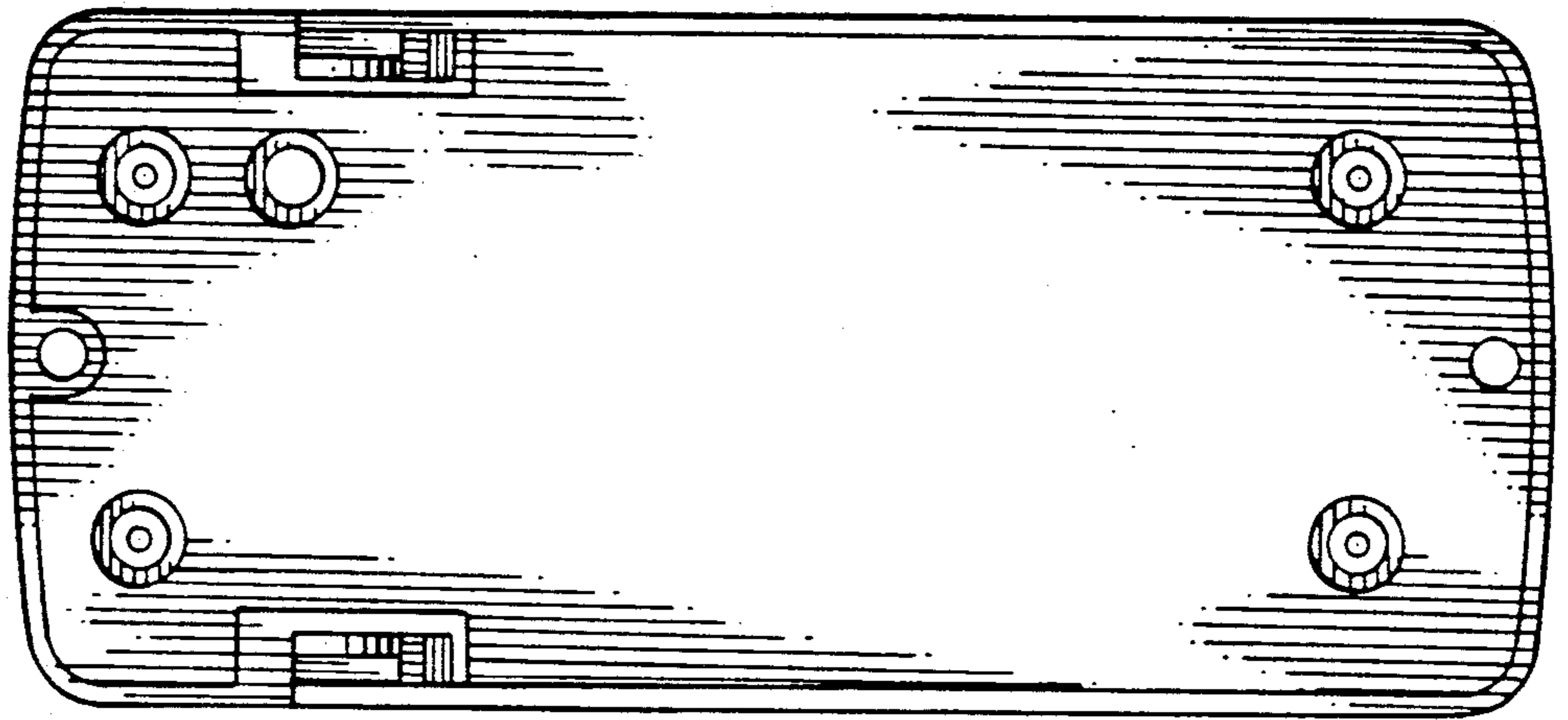

FIG. 5

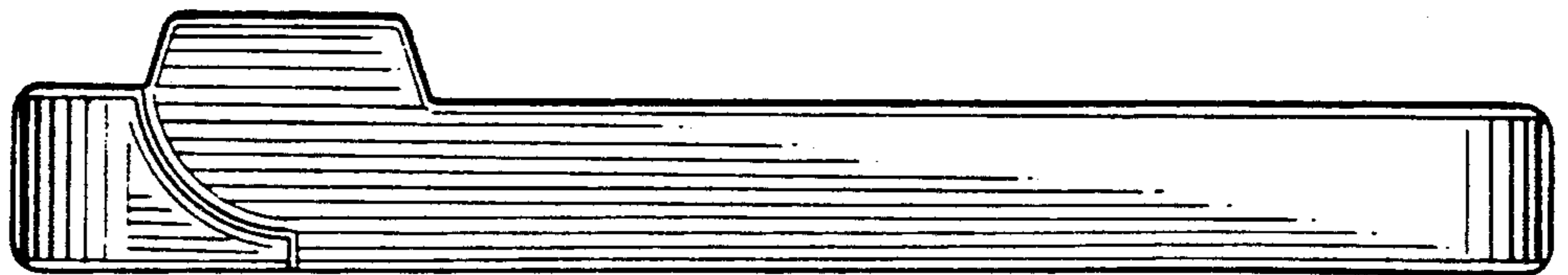

FIG. 8

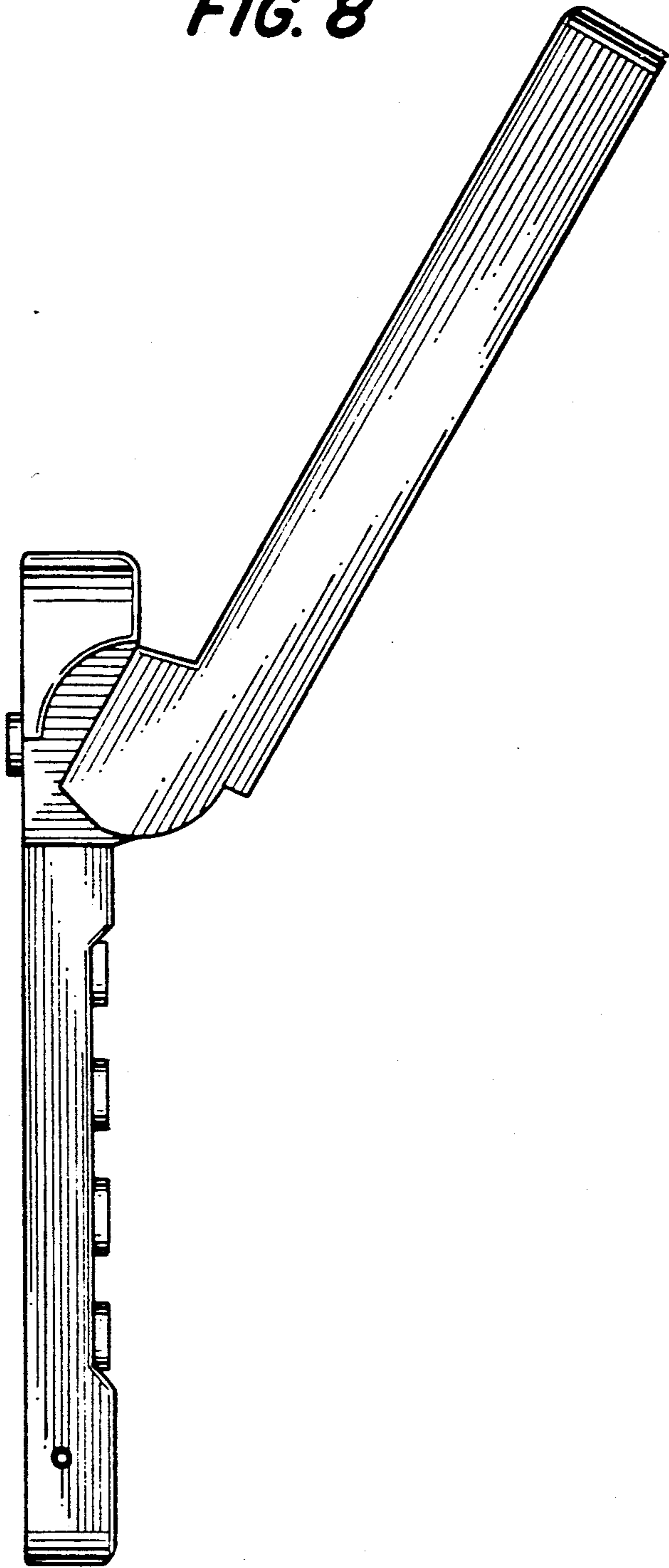

FIG. 9

