

[54] SHELF UNIT

[76] Inventor: Wayne C. Colman, 210 E. Water St., Troy, Ohio 45373

[**] Term: 14 Years

[21] Appl. No.: 392,392

[22] Filed: Aug. 11, 1989

[52] U.S. Cl. D6/566; D6/574; D6/510; D6/511; D34/42

[58] Field of Search D6/510-511, D6/512-513, 524-525, 553, 566-567, 574, 462, 475; 211/13, 42, 71, 87-88, 90, 104, 106, 126, 134, 181; 248/441.1, 175-176, 220.2, 235, 239, 249, 905; D34/40, 42

[56] References Cited

U.S. PATENT DOCUMENTS

D. 33,269	9/1900	Rix	D34/42 X
D. 115,255	6/1939	Taylor	D6/566
3,367,510	2/1968	Krikorian	211/181 X
3,730,108	5/1973	Stroh	211/181 X

3,978,799	9/1976	Escallette	211/88 X
4,511,047	4/1985	Elinsky	211/181 X
4,589,349	5/1986	Gebhardt et al.	211/181 X
4,960,214	10/1990	Sayers	211/181 X

Primary Examiner—Brian N. Vinson
Attorney, Agent, or Firm—Jacox & Meckstroth

[57] CLAIM

The ornamental design for a shelf unit, as shown and described.

DESCRIPTION

FIG. 1 is a top, front, and left side perspective view of a shelf unit showing my new design;
FIG. 2 is a left side elevational view thereof;
FIG. 3 is a front elevational view thereof;
FIG. 4 is a right side elevational view thereof;
FIG. 5 is a rear elevational view thereof;
FIG. 6 is a top plan view thereof;
FIG. 7 is a bottom plan view thereof; and
FIG. 8 is a top, front, and left side perspective view of an alternate embodiment thereof, the only difference residing in the article's width.

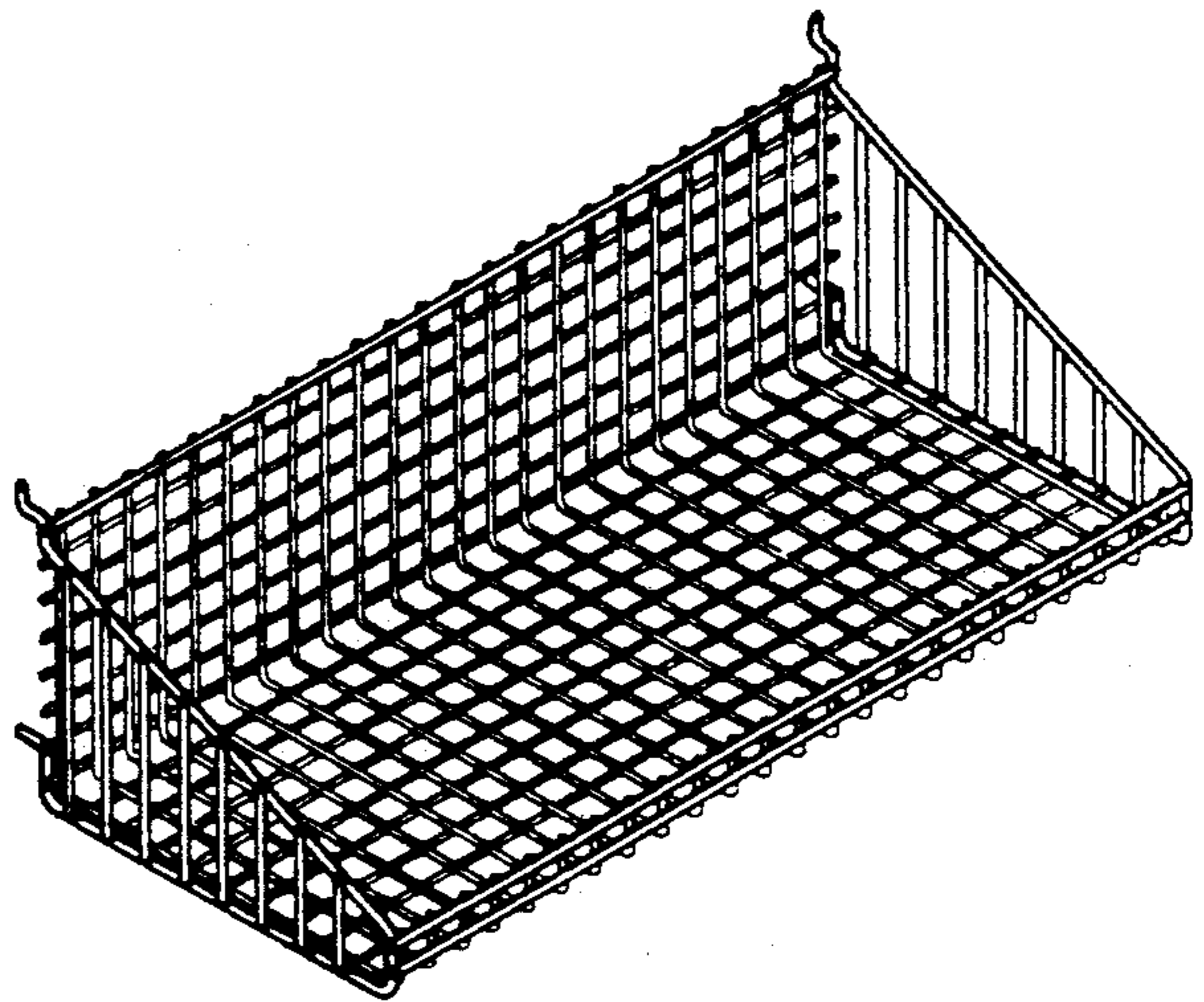
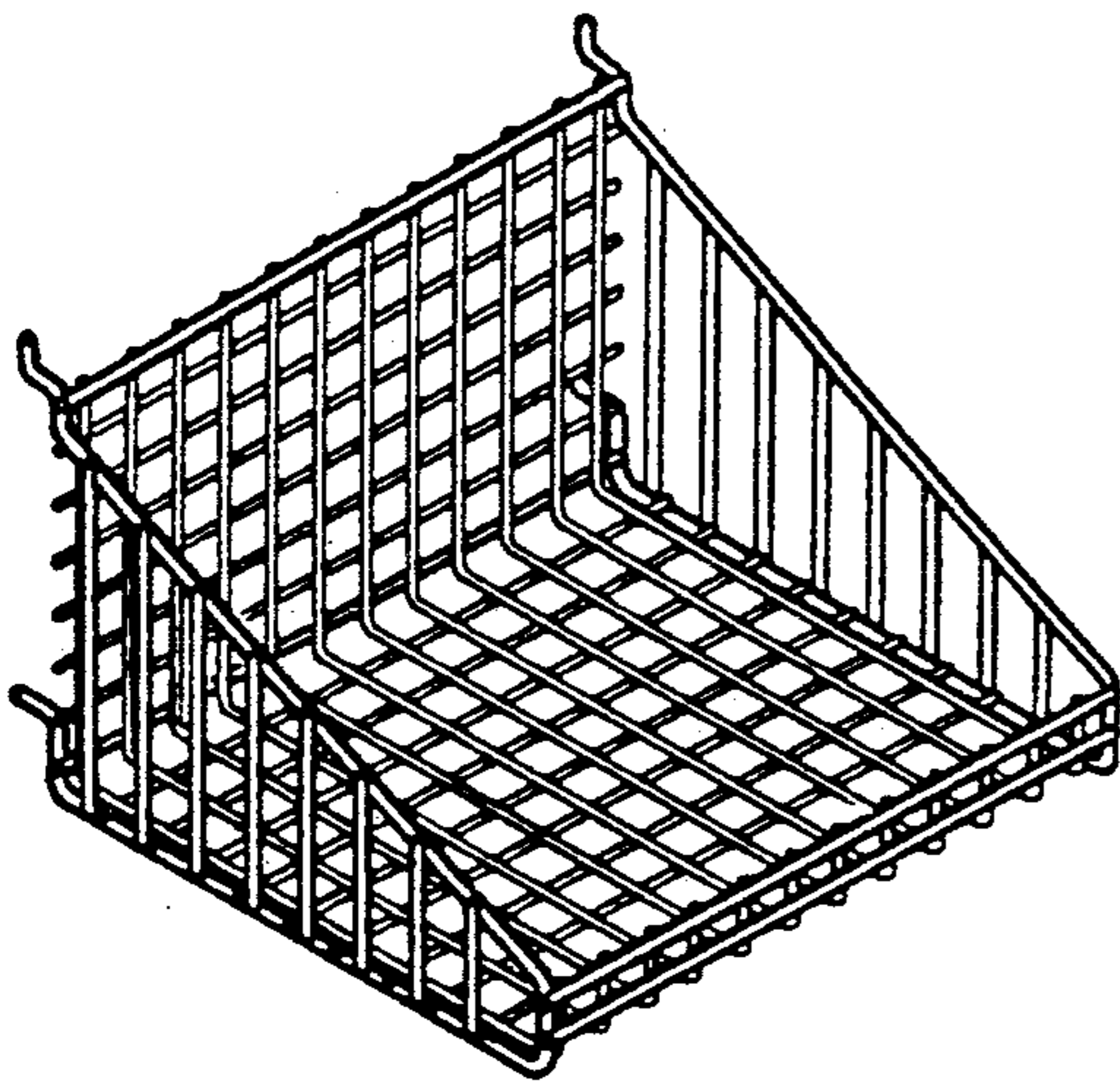

FIG-1

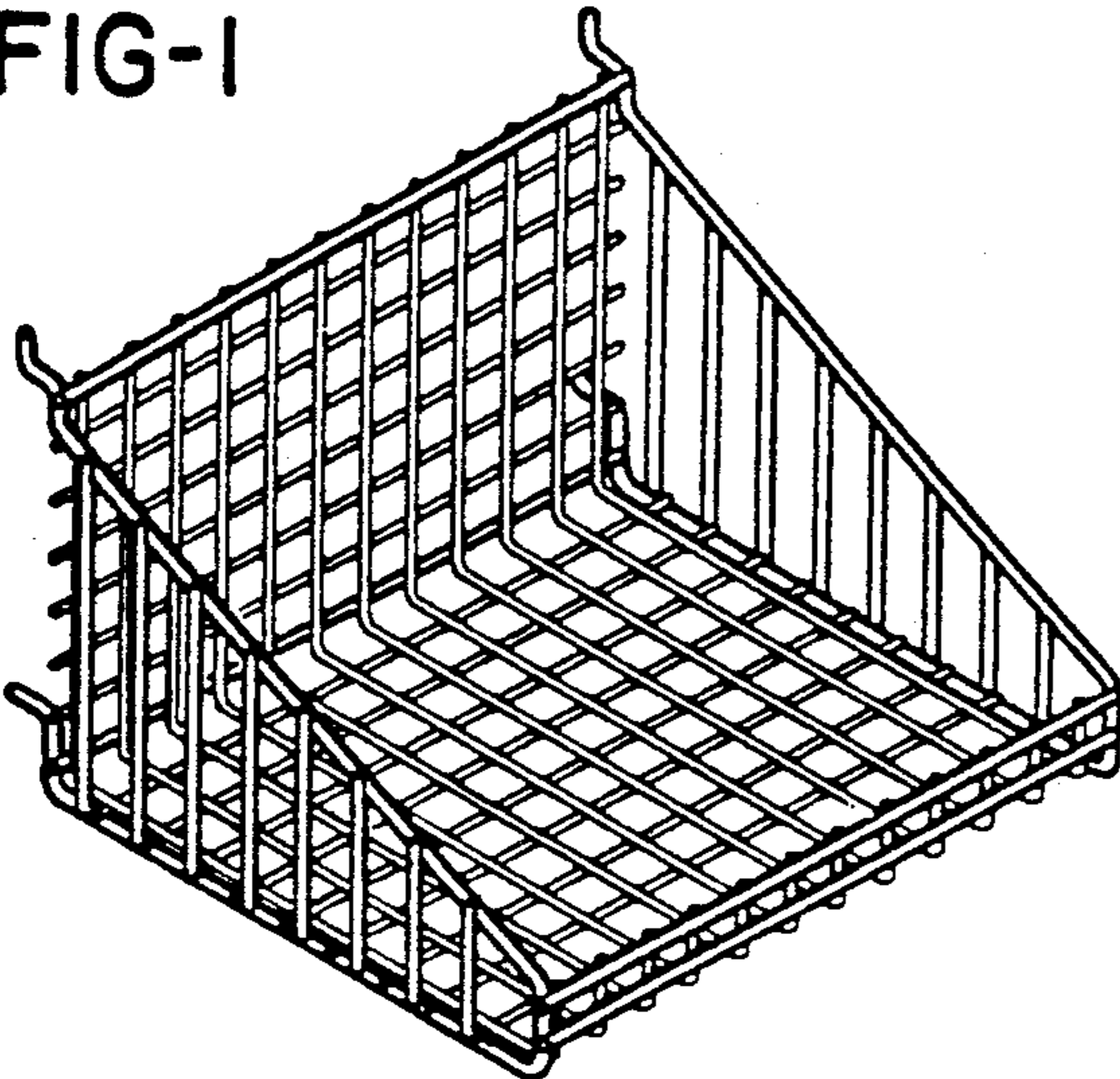

FIG-2

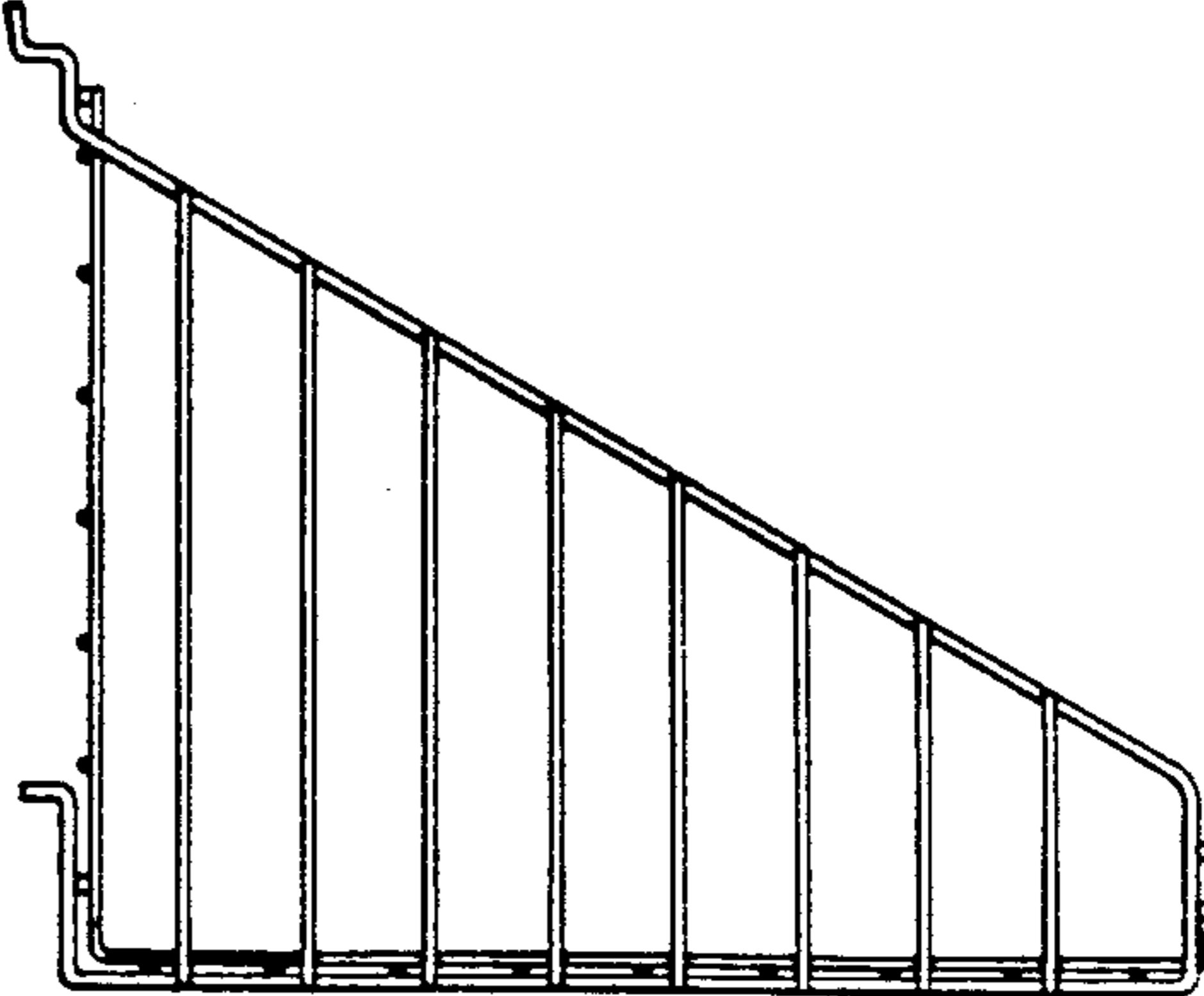

FIG-3

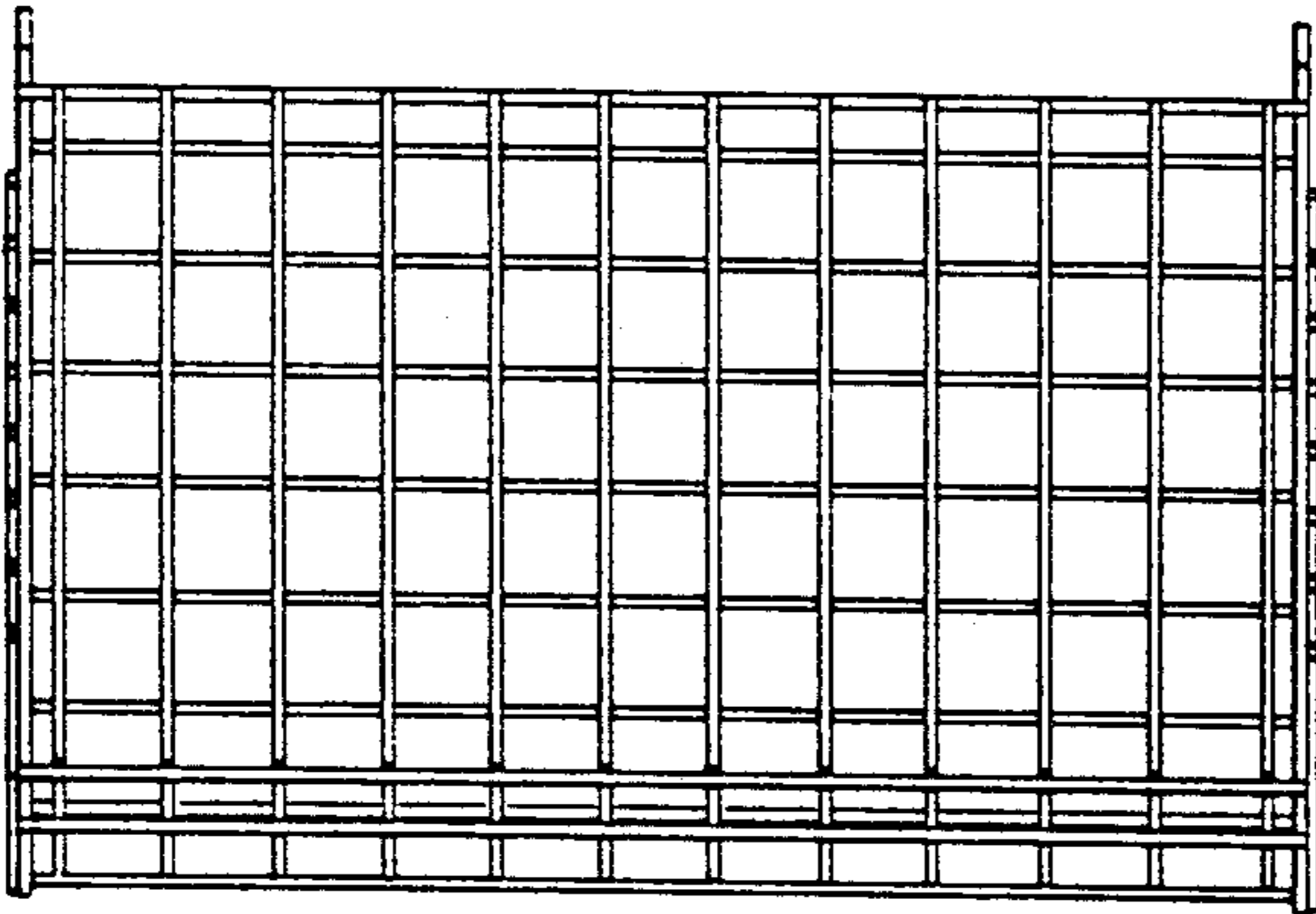

FIG-4

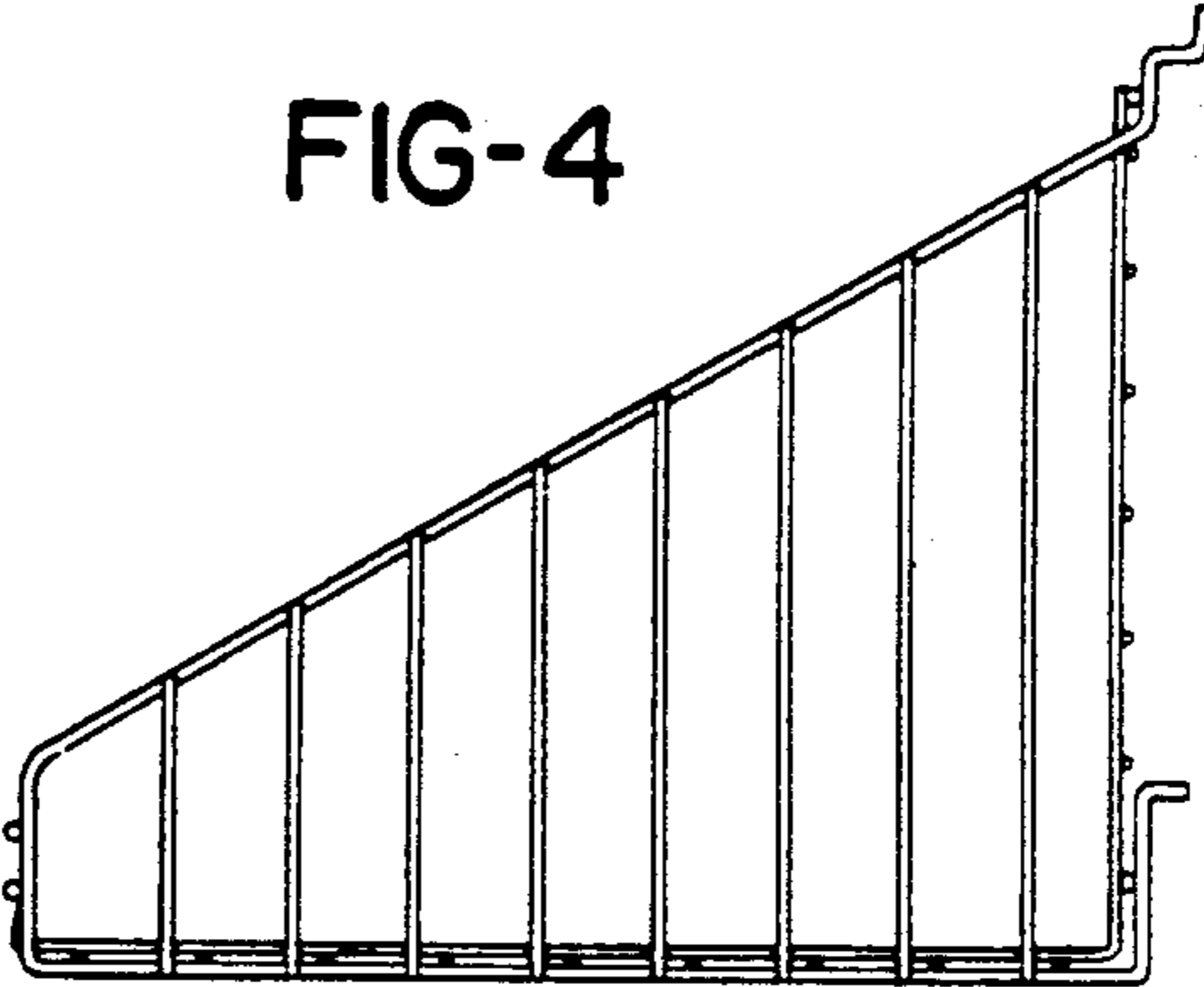

FIG-5

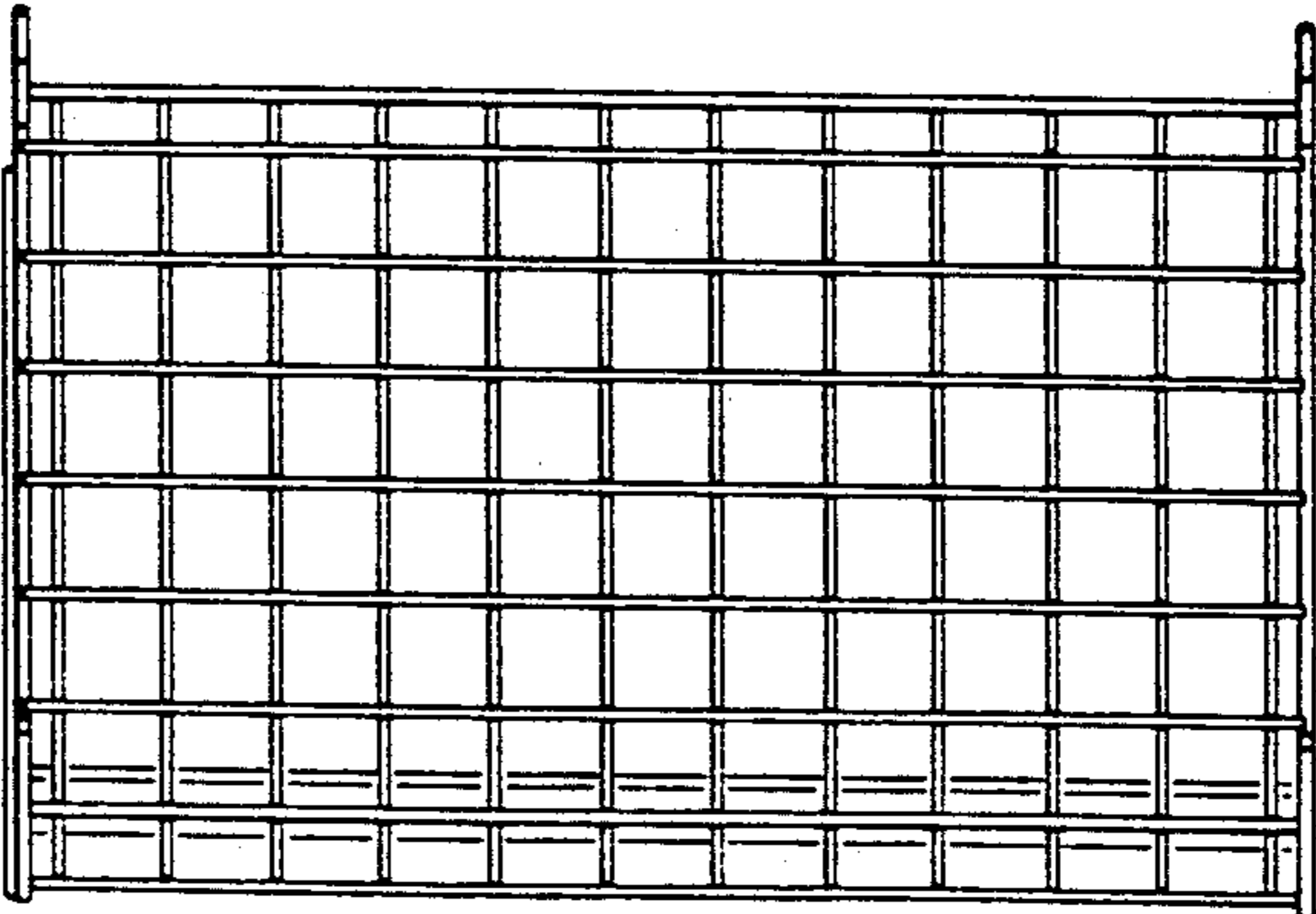

FIG-6

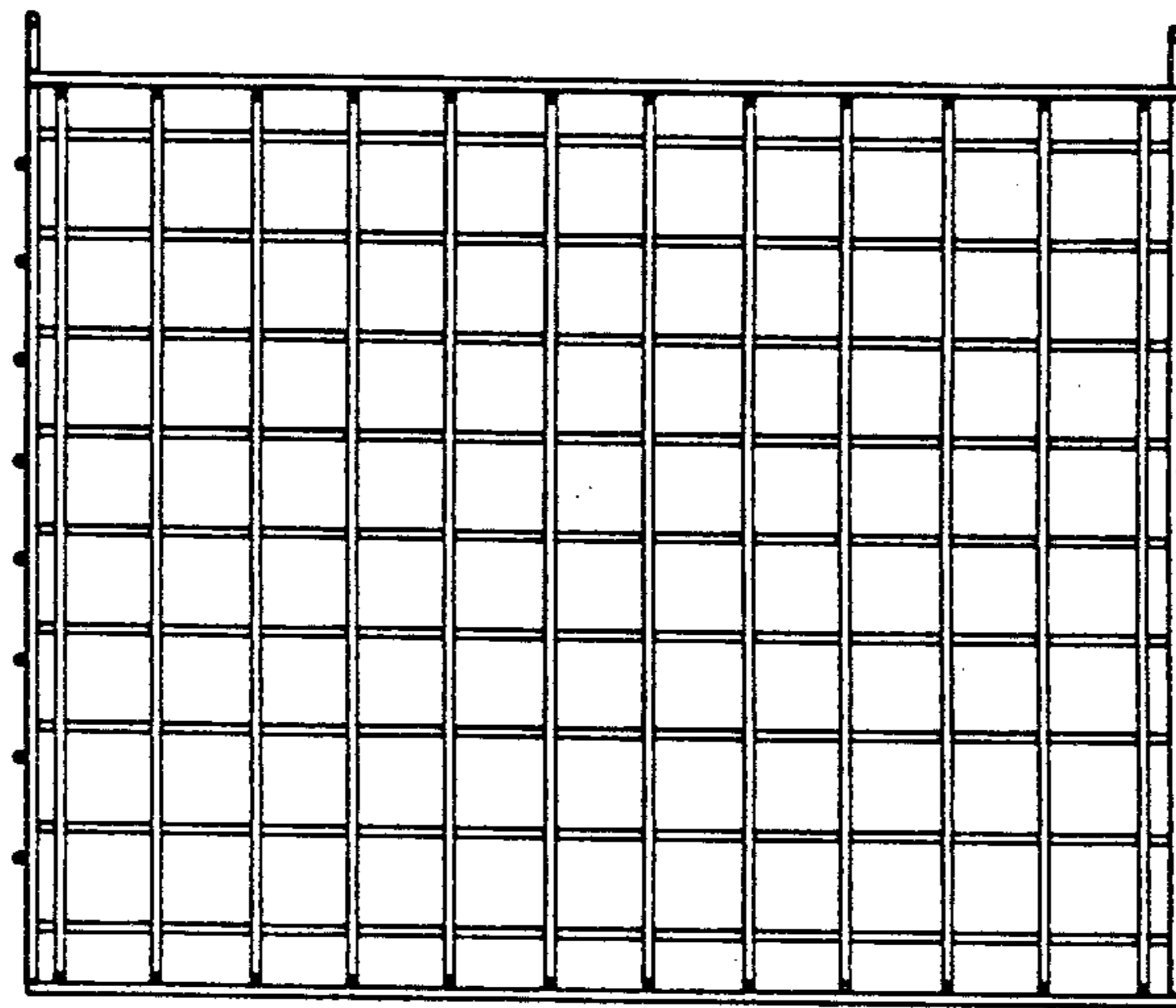

FIG-7

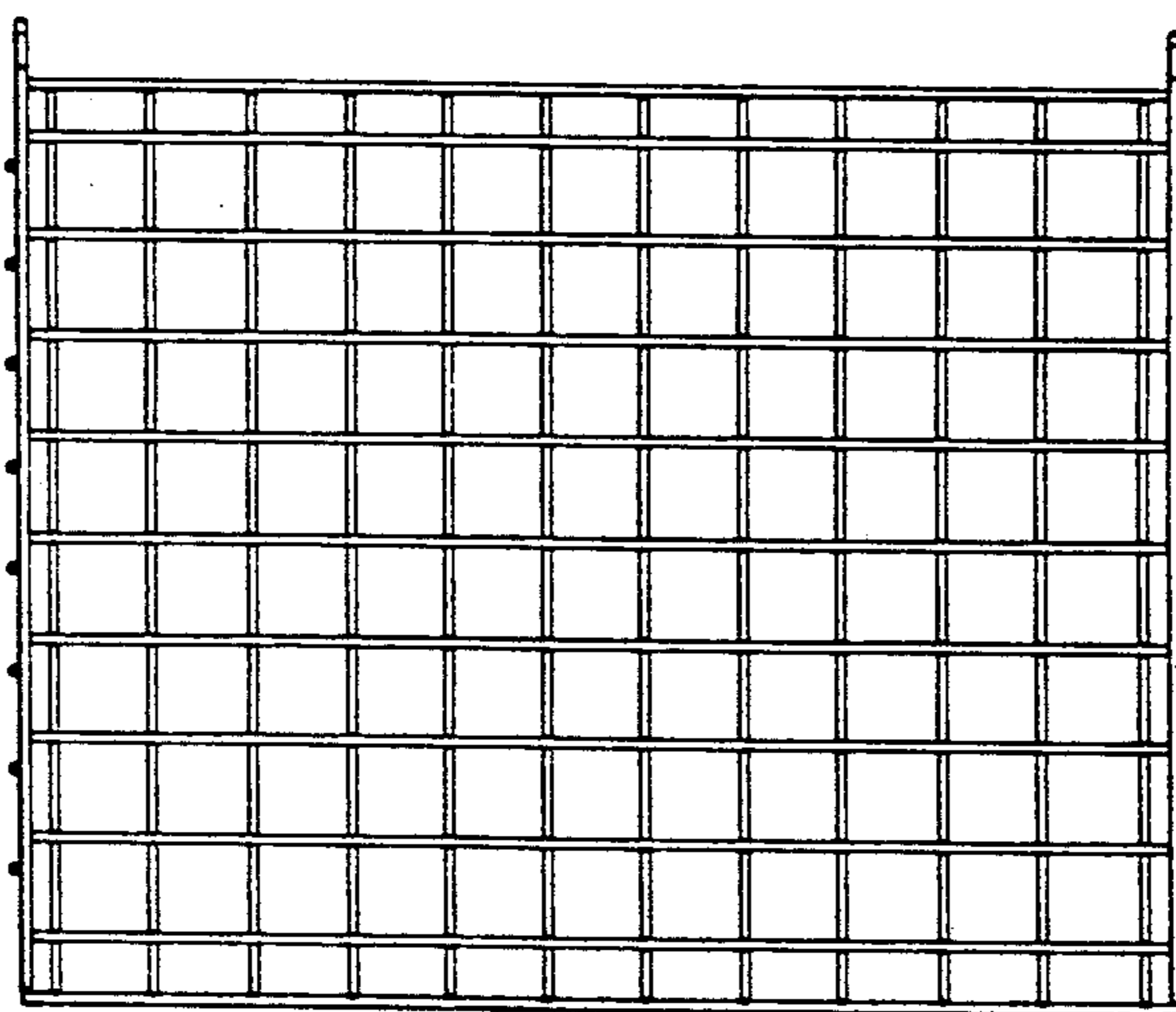

FIG-8

