

United States Patent [19]

Rockola et al.

[11] Patent Number: **Des. 322,286**

[45] Date of Patent: **** Dec. 10, 1991**

[54] **COMPACT DISC ALBUM COVER DISPLAY**

[75] Inventors: **Donald C. Rockola, Chicago; Shuja Haque, Northbrook, both of Ill.**

[73] Assignee: **Rock-Ola Manufacturing Corporation, Addison, Ill.**

[**] Term: **14 Years**

[21] Appl. No.: **352,059**

[22] Filed: **May 15, 1989**

[52] U.S. Cl. **D20/19; D20/10**

[58] Field of Search **D20/10, 18, 19, 39; 40/446, 447, 451, 452, 453, 479, 480, 493, 494, 541, 547; D3/301**

[56] **References Cited**

U.S. PATENT DOCUMENTS

D. 171,909	4/1954	Nelson	D20/10
D. 252,213	6/1979	Denhoff	D20/19
D. 268,502	4/1983	Wang	D20/18
D. 284,392	6/1986	Weil	D20/19
D. 305,672	1/1990	Corden et al.	D20/19
642,576	2/1900	Boydell	40/493
1,761,871	6/1930	Chapin et al.	40/542

2,963,807	12/1960	Relph et al.	D20/10
3,634,958	1/1972	Drowns	40/493
4,473,963	10/1984	Hardy et al.	40/124.1

Primary Examiner—Wallace R. Burke

Assistant Examiner—Marcus Jackson

Attorney, Agent, or Firm—McCaleb, Lucas & Brugman

[57] **CLAIM**

The ornamental design for a compact disc album cover display, as shown and described.

DESCRIPTION

FIG. 1 is a front elevational view of a compact disc album cover display showing our new design, with the broken line showing for illustrative purposes only and forming no part of the claimed design;

FIG. 2 is a front elevational view thereof, with the album covers omitted;

FIG. 3 is a perspective view thereof, with the cover shown in open condition;

FIG. 4 is a left side elevational view thereof, with the opposite side being a mirror image, and with the base omitted for ease of illustration;

FIG. 5 is a rear elevational view thereof;

FIG. 6 is a top plan view thereof.

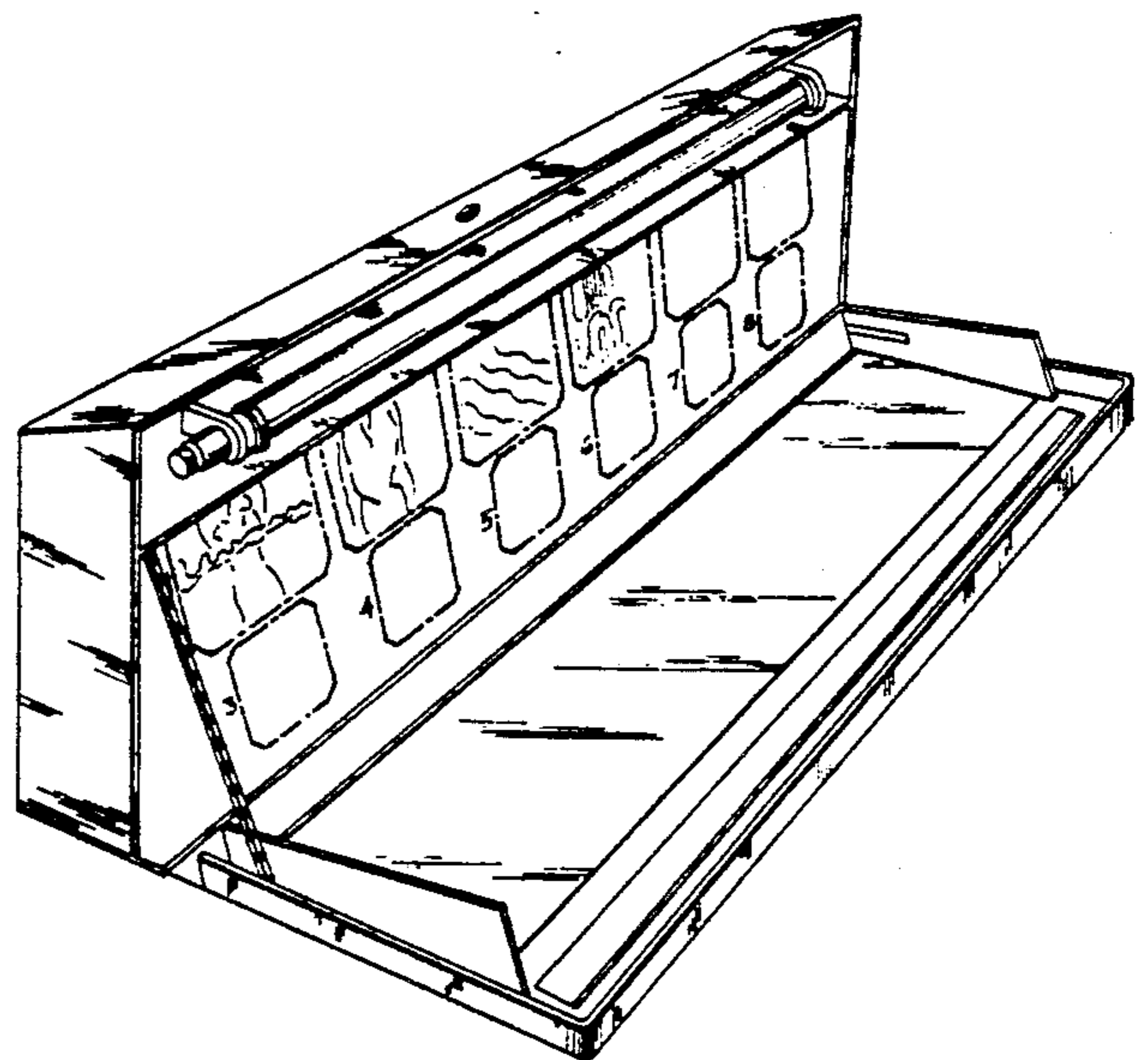
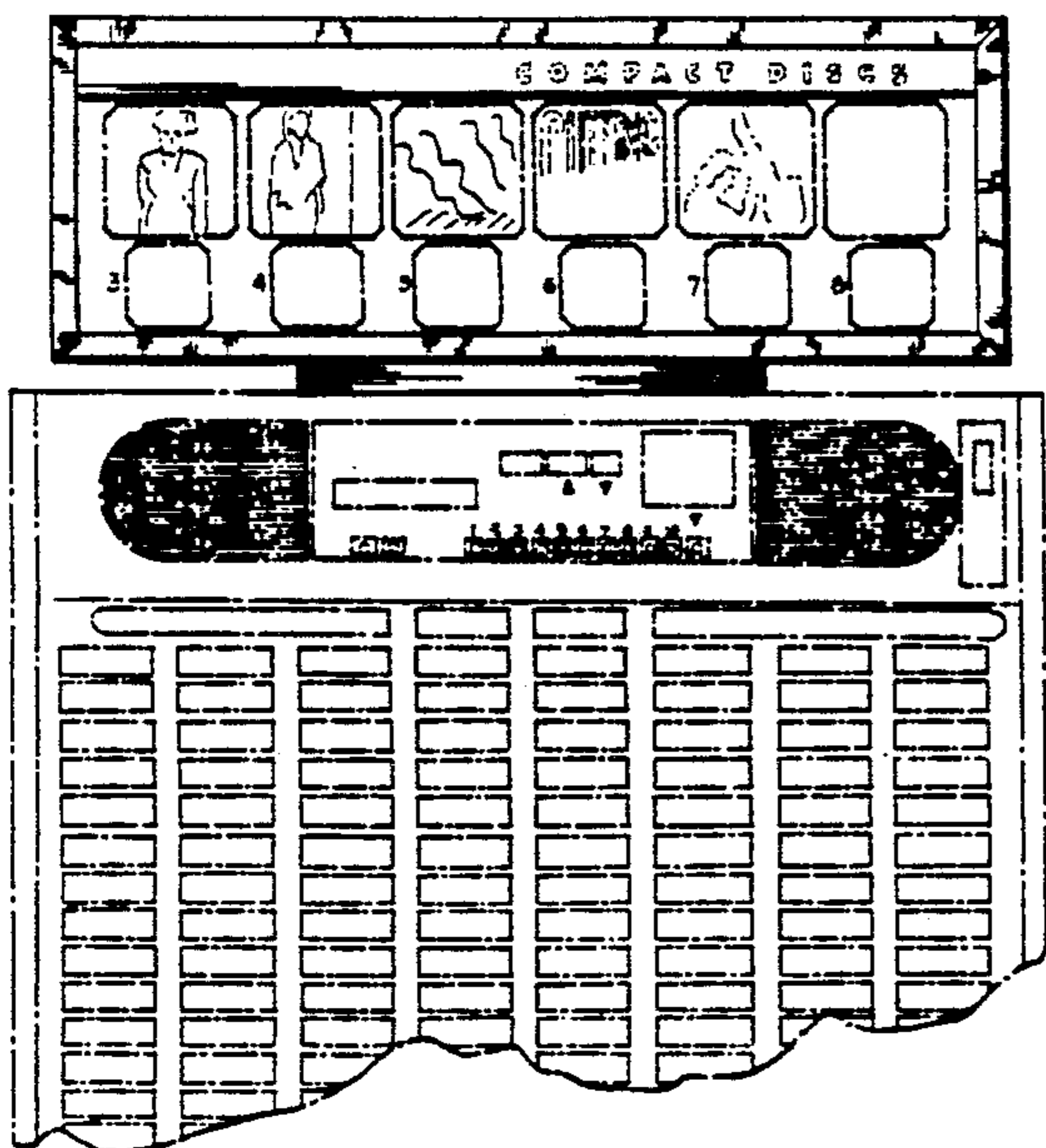

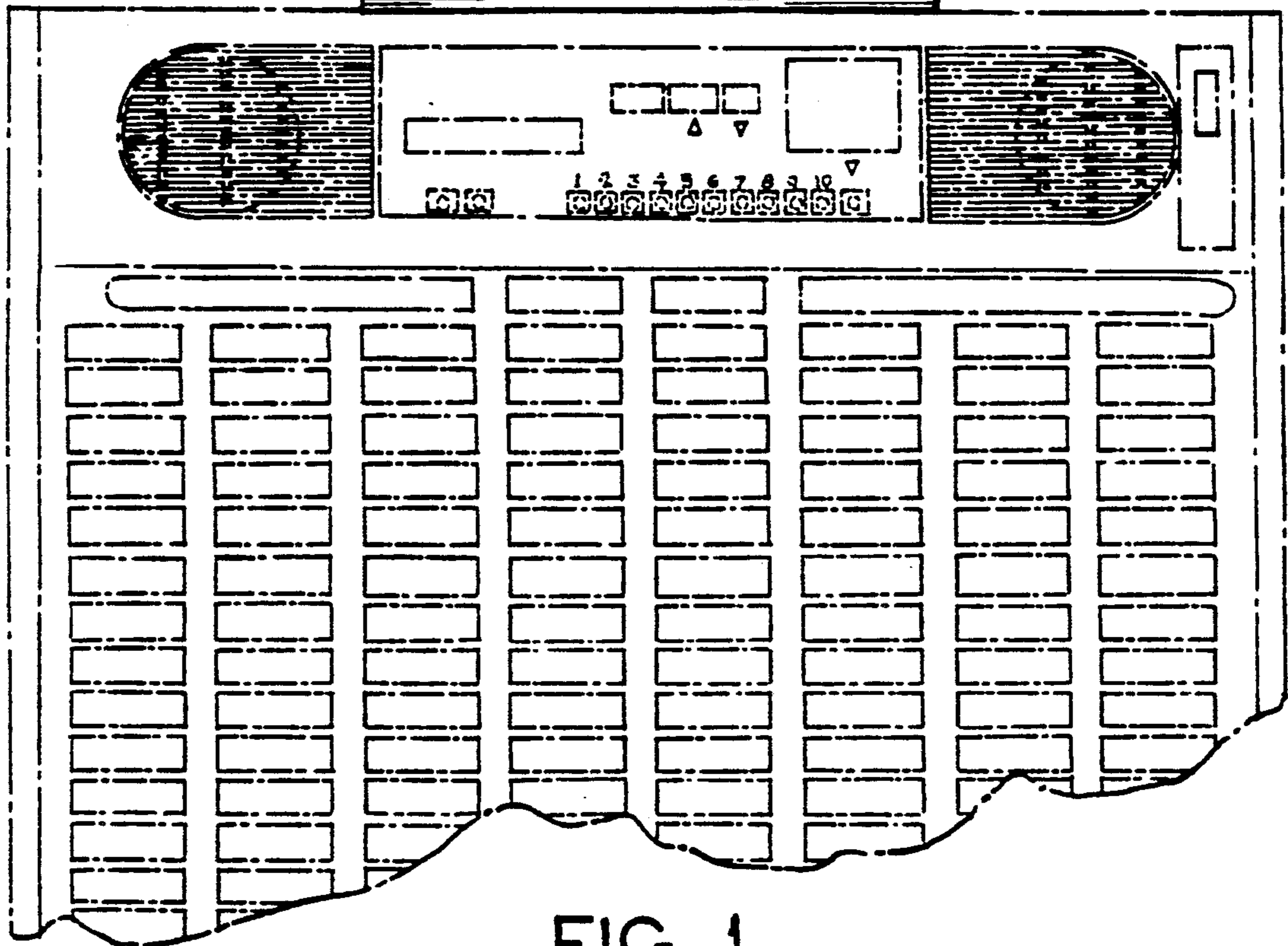
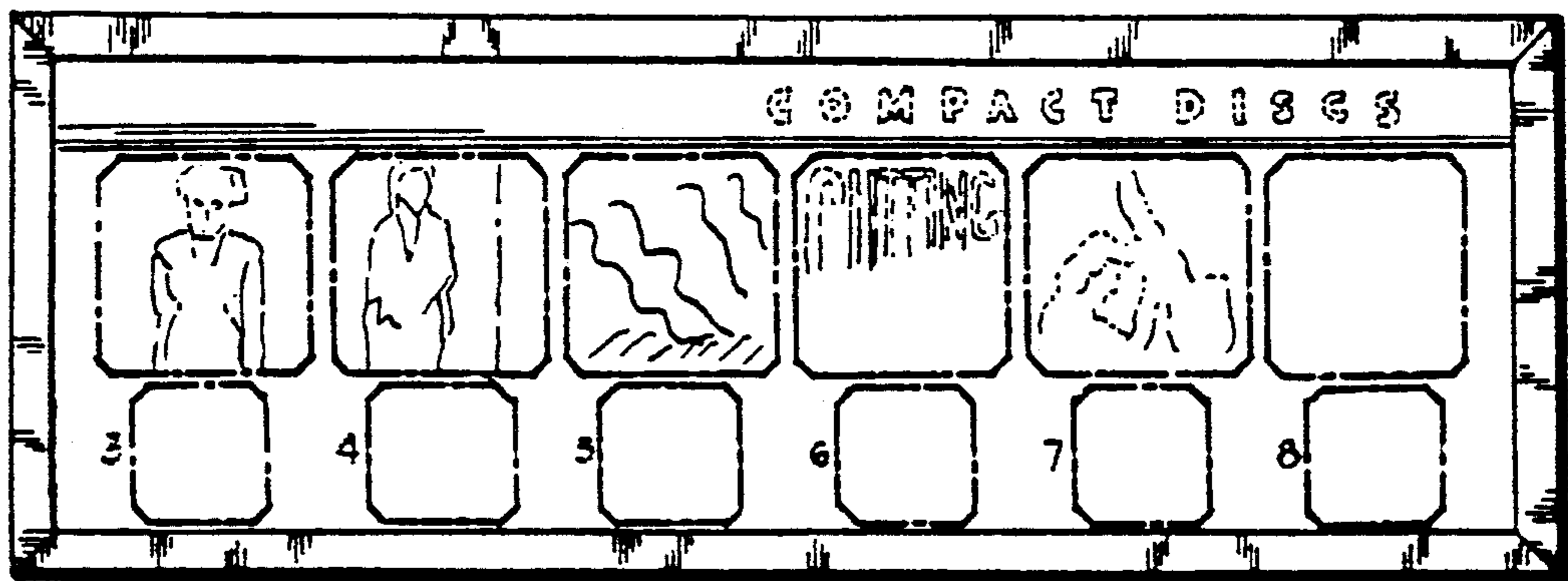

FIG. 1

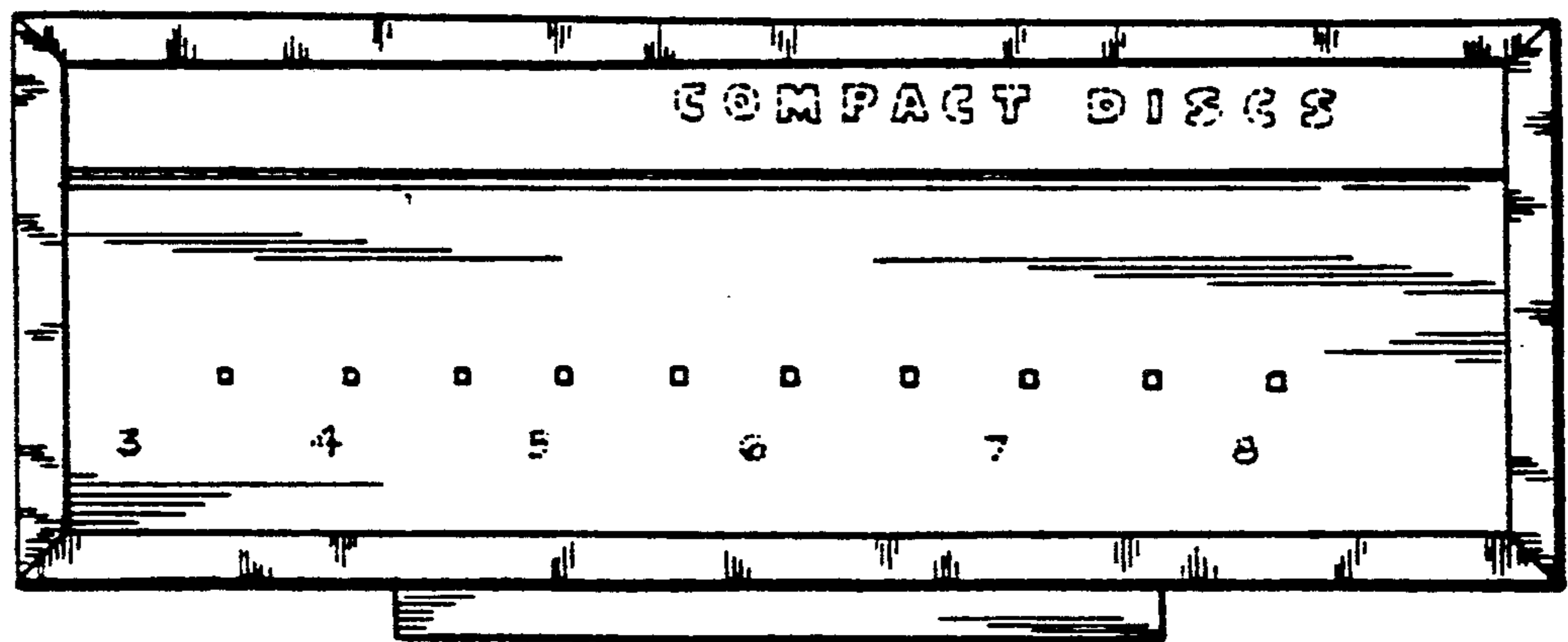

FIG. 2

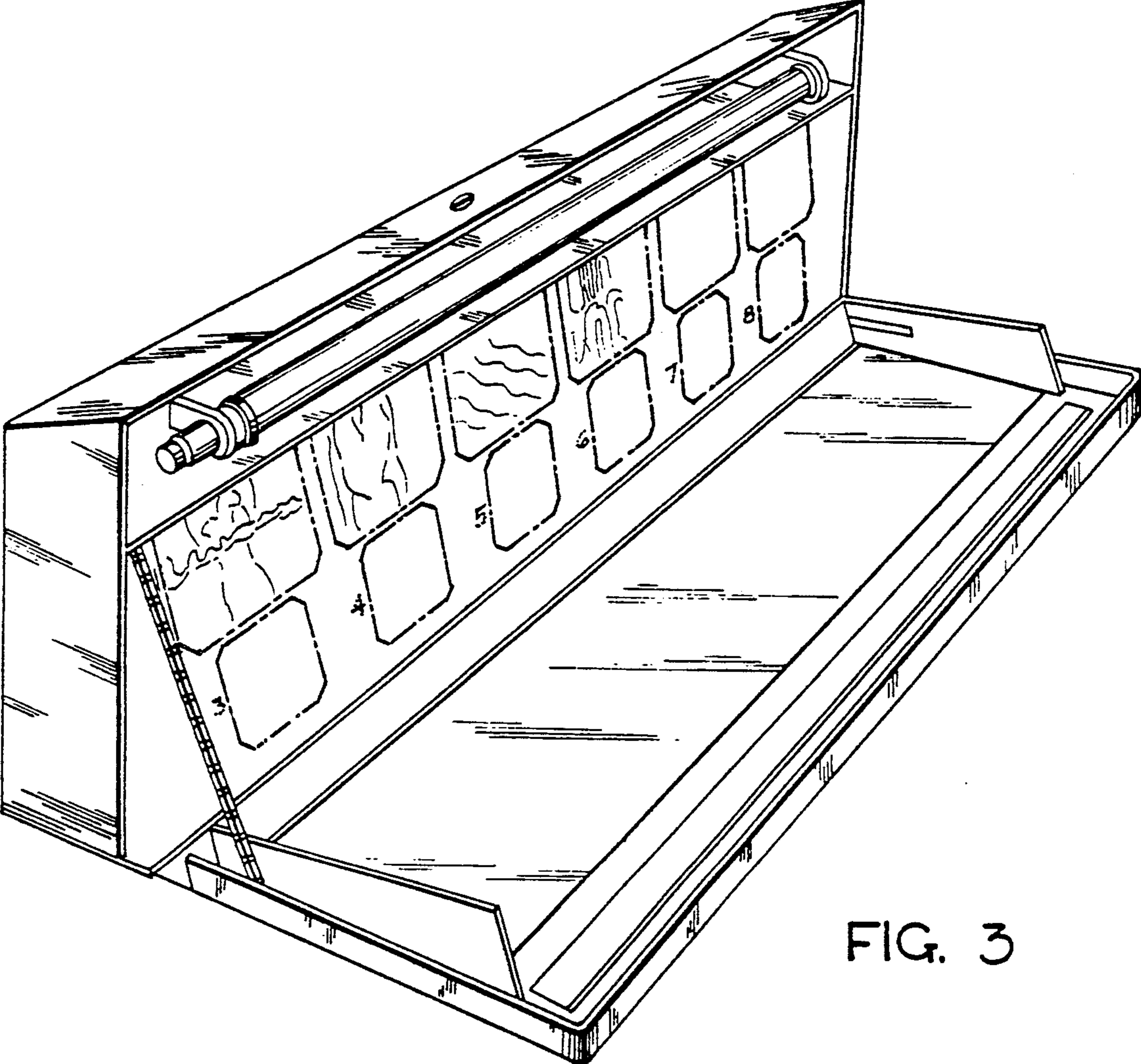

FIG. 3

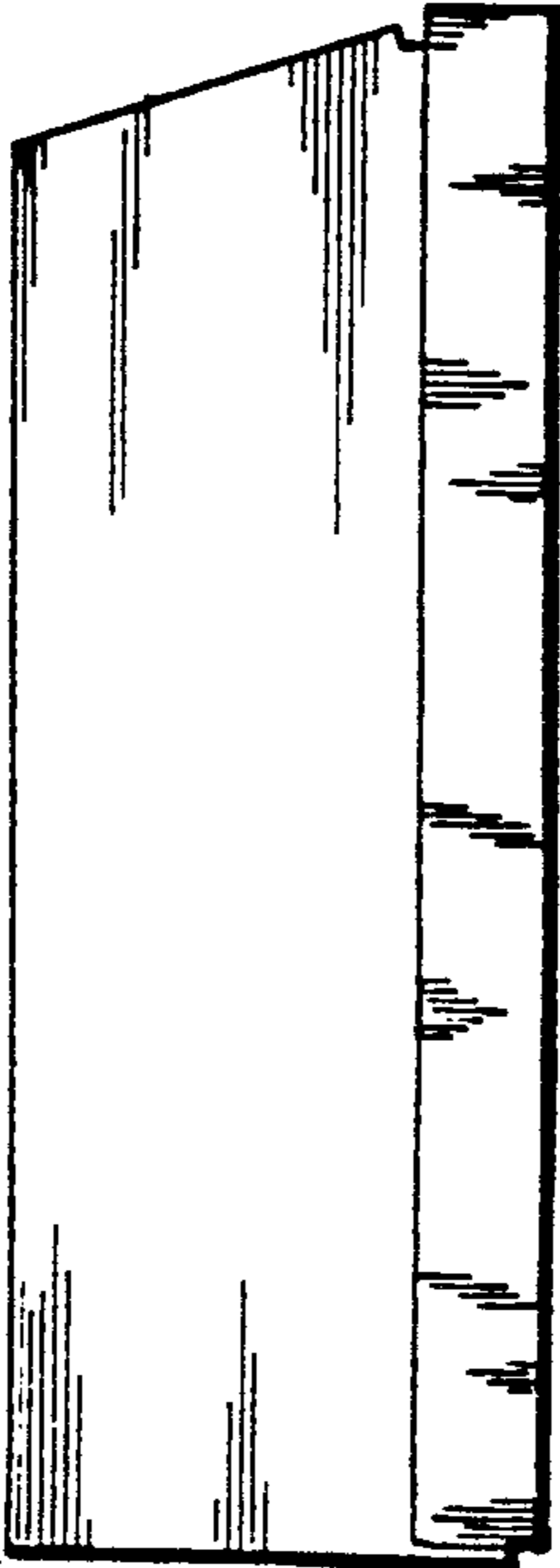

FIG. 4

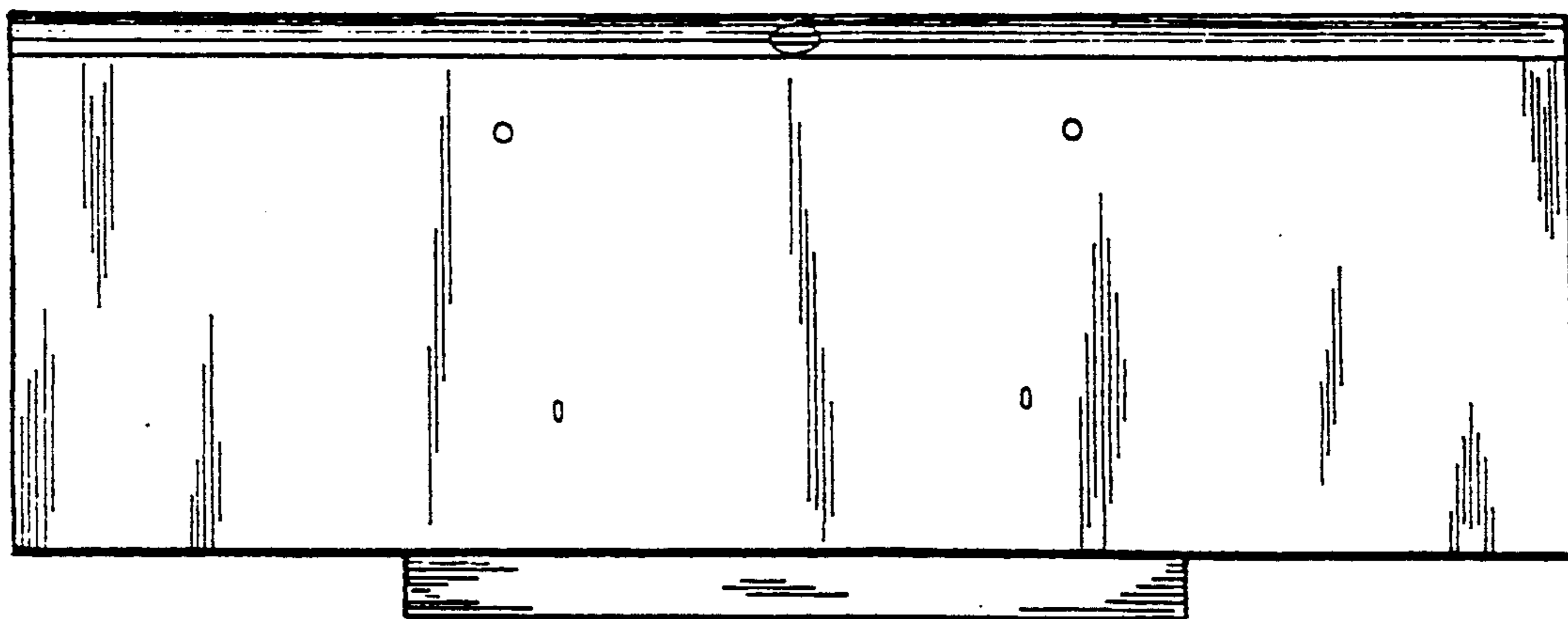

FIG. 5

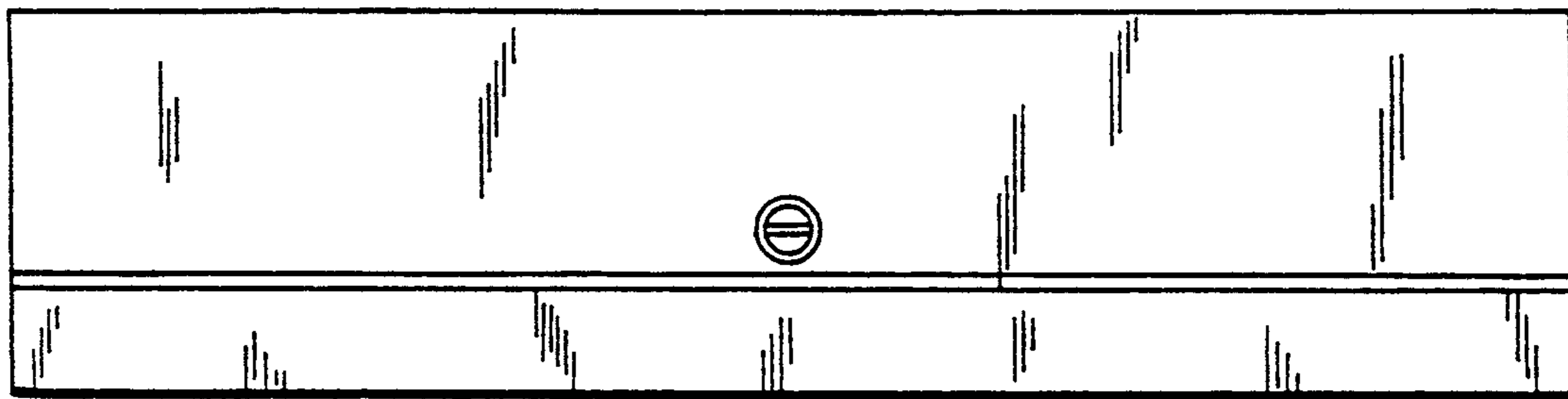

FIG. 6